

Lessons From Kosovo:

The KFOR Experience

Larry Wentz
Contributing Editor

CCRP

Report Documentation Page

Form Approved
OMB No. 0704-0188

Public reporting burden for the collection of information is estimated to average 1 hour per response, including the time for reviewing instructions, searching existing data sources, gathering and maintaining the data needed, and completing and reviewing the collection of information. Send comments regarding this burden estimate or any other aspect of this collection of information, including suggestions for reducing this burden, to Washington Headquarters Services, Directorate for Information Operations and Reports, 1215 Jefferson Davis Highway, Suite 1204, Arlington VA 22202-4302. Respondents should be aware that notwithstanding any other provision of law, no person shall be subject to a penalty for failing to comply with a collection of information if it does not display a currently valid OMB control number.

1. REPORT DATE JUL 2002		2. REPORT TYPE		3. DATES COVERED 00-07-2002 to 00-07-2002	
4. TITLE AND SUBTITLE Lessons From Kosovo: The KFOR Experience				5a. CONTRACT NUMBER	
				5b. GRANT NUMBER	
				5c. PROGRAM ELEMENT NUMBER	
6. AUTHOR(S)				5d. PROJECT NUMBER	
				5e. TASK NUMBER	
				5f. WORK UNIT NUMBER	
7. PERFORMING ORGANIZATION NAME(S) AND ADDRESS(ES) Office of the Assistant Secretary of Defense (OASD), Command & Control Research Program (CCRP), Washington, DC, 20301				8. PERFORMING ORGANIZATION REPORT NUMBER	
9. SPONSORING/MONITORING AGENCY NAME(S) AND ADDRESS(ES)				10. SPONSOR/MONITOR'S ACRONYM(S)	
				11. SPONSOR/MONITOR'S REPORT NUMBER(S)	
12. DISTRIBUTION/AVAILABILITY STATEMENT Approved for public release; distribution unlimited					
13. SUPPLEMENTARY NOTES					
14. ABSTRACT					
15. SUBJECT TERMS					
16. SECURITY CLASSIFICATION OF:			17. LIMITATION OF ABSTRACT	18. NUMBER OF PAGES 769	19a. NAME OF RESPONSIBLE PERSON
a. REPORT unclassified	b. ABSTRACT unclassified	c. THIS PAGE unclassified			

About the CCRP

The Command and Control Research Program (CCRP) has the mission of improving DoD's understanding of the national security implications of the Information Age. Focusing upon improving both the state of the art and the state of the practice of command and control, the CCRP helps DoD take full advantage of the opportunities afforded by emerging technologies. The CCRP pursues a broad program of research and analysis in information superiority, information operations, command and control theory, and associated operational concepts that enable us to leverage shared awareness to improve the effectiveness and efficiency of assigned missions. An important aspect of the CCRP program is its ability to serve as a bridge between the operational, technical, analytical, and educational communities. The CCRP provides leadership for the command and control research community by:

- articulating critical research issues;
- working to strengthen command and control research infrastructure;
- sponsoring a series of workshops and symposia;
- serving as a clearing house for command and control related research funding; and
- disseminating outreach initiatives that include the CCRP Publication Series.



This is a continuation in the series of publications produced by the Center for Advanced Concepts and Technology (ACT), which was created as a “skunk works” with funding provided by the CCRP under the auspices of the Assistant Secretary of Defense (C3I). This program has demonstrated the importance of having a research program focused on the national security implications of the Information Age. It develops the theoretical foundations to provide DoD with information superiority and highlights the importance of active outreach and dissemination initiatives designed to acquaint senior military personnel and civilians with these emerging issues. The CCRP Publication Series is a key element of this effort.

Check our Web site for the latest CCRP activities and publications.

www.dodccrp.org



DoD Command and Control Research Program

ASSISTANT SECRETARY OF DEFENSE (C3I)
&
CHIEF INFORMATION OFFICER

Mr. John P. Stenbit

PRINCIPAL DEPUTY ASSISTANT SECRETARY OF DEFENSE (C3I)

Dr. Linton Wells, II

SPECIAL ASSISTANT TO THE ASD(C3I)
&
DIRECTOR, RESEARCH AND STRATEGIC PLANNING

Dr. David S. Alberts

Opinions, conclusions, and recommendations expressed or implied within are solely those of the authors. They do not necessarily represent the views of the Department of Defense, or any other U.S. Government agency. Cleared for public release; distribution unlimited.

Portions of this publication may be quoted or reprinted without further permission, with credit to the DoD Command and Control Research Program, Washington, D.C. Courtesy copies of reviews would be appreciated.

Library of Congress Cataloging-in-Publication Data

Lessons from Kosovo : KFOR experience / edited by Larry K. Wentz.

p. cm. -- (CCRP publication series)

ISBN 1-893723-05-4 (pbk.)

1. Kosovo (Serbia)--History--Civil War, 1998- .--Peace. 2. North Atlantic Treaty Organization--Yugoslavia--Serbia. I. Wentz, Larry K. II. Series.

DR2087.6.P43 L47 2002

949.7103--dc21

2001006352

July 2002

Lessons From Kosovo: The KFOR Experience

**Larry Wentz
Contributing Editor**





ITALY

- Republic boundaries
- Autonomous provinces, Territories
- International boundaries
- Coastal agreement line

0 100 200 Kilometers
0 100 200 Miles

ALBANIA

GREECE

1
2
3
4
5

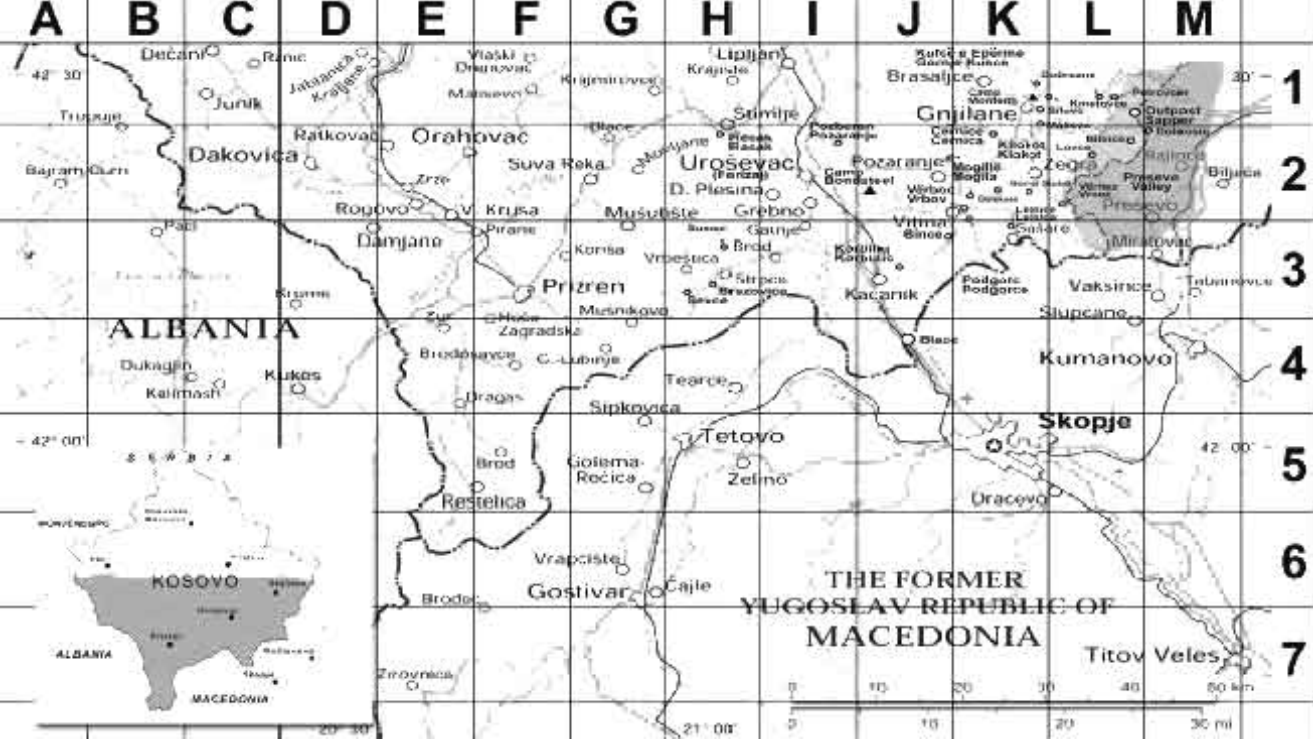

TABLE OF CONTENTS

Foreword	v
Acknowledgments	ix
Preface	xiii
Section 1—Introduction	1
Chapter I-Introduction-Larry Wentz	3
Chapter II-Background-Larry Wentz	15
Section 2—Political Dimensions	47
Chapter III-Kosovo and Bosnia: Different Products of Yugoslavia’s Disintegration-Jusuf Fuduli	49
Chapter IV-Kosovo’s Political Evolution-Jusuf Fuduli	65
Chapter V-The Kosovo Elections-Rich DuBreuil and Joseph Nowick	77
Section 3—Air War and Related Media Challenges	95
Chapter VI-Air War Over Serbia-Patrick Sheets	97

Chapter VII-Operation Allied Force: Air Traffic Management- <i>Paul Miller</i>	115
Chapter VIII-The Forgotten Echelon: NATO Headquarters Intelligence During the Kosovo Crisis- <i>Patrick Duecy</i>	123
Chapter IX-The Kosovo Crisis and the Media: Reflections of a NATO Spokesman- <i>Dr. Jamie P. Shea</i>	153
Chapter X-Operation Allied Force: The Media and the Public- <i>Pascale Combelles Siegel</i>	175
Section 4—Civil-Military Dimensions	205
Chapter XI-The Humanitarian Dimension in Kosovo: Coordination and Competition- <i>Walter Clarke</i>	207
Chapter XII-Law and Order in Kosovo: A Look at Criminal Justice During the First Year of Operation Joint Guardian- <i>CPT Alton L. Gwaltney, III</i>	233
Chapter XIII-The Operational Art of Civil-Military Operations: Promoting Unity of Effort- <i>Christopher Holshek</i>	269
Chapter XIV-Shaping the Environment for Future Operations: Experiences with Information Operations in Kosovo- <i>Steven M. Seybert</i>	311

Section 5—Task Force Falcon: A Snapshot in Time	351
Chapter XV-Introduction-Larry Wentz	353
Chapter XVI-The Kosovo Environment-Larry Wentz	361
Chapter XVII-Peacekeeper Quality of Life-Larry Wentz	383
Chapter XVIII-Coalition Command Arrangements-Larry Wentz	399
Chapter XIX-Operations-Larry Wentz	425
Chapter XX-Intelligence and Situation Awareness-Larry Wentz	447
Chapter XXI-Civil-Military Operations-Larry Wentz	483
Chapter XXII-Information Campaign-Larry Wentz	507
Chapter XXIII-Public Affairs-Larry Wentz	527
Chapter XXIV-Communications Systems-Larry Wentz	543
Chapter XXV-Kosovo Communications Commercialization: USAREUR Experiences-Danny Johnson and Paul Meaker ...	591

Chapter XXVI-Field Experience- <i>Larry Wentz</i>	603
Chapter XXVII-A Continuous Learning Process- <i>Larry Wentz</i>	629
Chapter XXVIII-Section 5 References	643
Section 6—Coordination and Information Sharing	649
Chapter XXIX-Information Sharing in Kosovo: A Humanitarian Perspective- <i>Molly Inman</i>	651
Chapter XXX-Peace Support Operations Cooperation, Coordination, and Information Sharing: Lessons from Kosovo- <i>Larry Wentz</i>	671
Appendix A-Military Technical Agreement	A-1
Appendix B-United Nations Security Council Resolution 1244 (1999)	B-1
Appendix C-Acronym List	C-1

FOREWORD

Civil-military unity of effort has been an essential yet frustrating elusive requirement for success in post-cold-war peace operations. The need to coordinate, collaborate, and share information between civilian and military entities is on the rise and deemed essential requirements for success. Today's information and communications technologies serve to facilitate the exchange of information among the disparate players of peace operations but the ability to actually realize open information sharing in real-world coalition operations remains problematic. The integration of relevant information and the timely dissemination of the processed information to interested parties in the field is well within the realities of today's technology.

Increased civil-military involvement in peacekeeping and humanitarian operations around the world is matched in part by the rise in the number and complexity of these situations. There are many more actors on today's peace operations landscape with competing as well as common interests and expectations. The need to improve cooperation, coordination, and more open information sharing is on the rise. Efforts to improve and facilitate more open working together and information sharing among the disparate participants must overcome a continuing lack of trust among the civil-military actors, obsolete national and international policies, unrealistic legal and funding constraints, and outdated organization cultural traditions and behavior patterns. Additionally, all actors need to better understand each other and the roles they can and should play in an increasingly complex operational environment. In order to obtain closure and improve the future situation, the actors must develop relationships based on mutual trust, and there must be a clear understanding that cooperation, coordination, and information sharing is a two-way street.

In reality, inefficiencies are inherent in any multilateral activity, and competing interests and fear of loss of power and prestige make unity of effort a desired objective, but also one that will be difficult to achieve. Furthermore, information is power and can be an effective means to an end, but only if it can be interpreted, shared, and used effectively for military, political, or civil use. Information can also help reduce

uncertainty and provide those that possess it a decided advantage in the decisionmaking process. There continues to be a general lack of trust among the players, coupled with the lack of a shared understanding of the added value through more open and improved information sharing. Information sharing among the actors on the peace operations landscape continues to be largely a manual process. These obstacles need to be recognized and, to the extent possible, practical recommendations developed for ameliorating them. Application of new technology must go beyond simply modernizing existing practices and capabilities. The civil-military community needs to look at new ways of doing business and how the rapidly advancing information technology can be used to leverage the power of information to help achieve timely and appropriate success of peace operations.

The patterns of conflict for the post-cold-war environment are changing and so are the approaches to military command and control. Advances in information technology have enabled organizations and individuals to more effectively leverage the power of information; yet for coalition operations where information sharing is essential to meet mission needs, it continues to be problematic. The issue is not technology, but largely the will on the part of organizations and individuals to make it happen. There is also a number of policy, doctrine, C4ISR systems, cultural, and environmental challenges that influence the ability to achieve more open sharing of information in coalition operations.

The ASD (C3I) Command and Control Research Program (CCRP) performs an important role in bringing to the attention of DoD and international C4ISR communities an informed understanding and reality check of important focused research on C4ISR-related and civil-military issues. Its outreach program focuses on providing educational products that can be used by the professional military education program. Service and Defense universities and colleges use these products in their debates on real-world lessons and assessments of concepts for military support to future operations, such as the peace operations in the Balkans. CCRP research activities and publications can be found on the CCRP Web site at <http://www.dodccrp.org>

For the Balkans operations, CCRP led a study of the U.S. participation in the Bosnia operation, the NATO-led Implementation Force (IFOR). The use of Bosnia lessons learned roundtables, workshops, symposia, and CCRP publications such as *Lessons from Bosnia: The IFOR*

Experience, Target Bosnia: Integrating Information Activities in Peace Operations, and *Information Campaigns for Peace Operations*, allowed CCRP to make meaningful contributions to informing and educating the C4ISR community on the experiences and lessons from IFOR and early phases of the follow-on Stabilization Force (SFOR) effort. Focused research addressed IFOR issue areas such as C4ISR network interoperability and information operations. Kosovo offered another unique opportunity for CCRP to conduct additional coalition C4ISR-focused research in the areas of coalition command and control, civil-military cooperation, information assurance, C4ISR interoperability, and information operations. The Kosovo research effort was launched in the fall of 1999 and completed in the summer of 2001. Insights from the Kosovo experience documented in this book are part of the continuing effort of CCRP to educate the C4ISR community on the realities of military support to multinational peace operations.

ACKNOWLEDGMENTS

This book is the product of the OASD (C3I) Command and Control Research Program (CCRP) outreach policy to bring an informed understanding of important C2 and C4ISR systems issues to the attention of the DoD and International Civil-Military community. As the Kosovo study director and contributing editor of this book (and an earlier CCRP-sponsored study and book on Bosnia), I am in debt to Dr. David S. Alberts, the Director, Research OASD (C3I), for his support and affording me the opportunity to once again lead a most challenging and interesting undertaking in the Balkans—a unique and unforgettable personal experience.

There were of course many people who have contributed to this effort and certainly more than I can remember and mention here. A special thanks goes to the men and women of the military, civilian workforce, and contractors who were in Kosovo and those who supported them—in particular, those who took time out of a demanding and intensive work environment to share their experiences and lessons with me. Once again, numerous organizations and their staff provided professional insights, experiences, and lessons for the study. Contributors included EUCOM, USAREUR/5th Signal Command, 7th Signal Brigade, USAFE/Warrior Preparation Center, NAVEUR, 26th MEU, NATO CAOC, DISA-EUR, ASD (C3I), Joint Staff, Army War College Peacekeeping Institute, CALL, LIWA, NATO, SHAPE, NC3A, Air Force Historian, KFOR, ARRC, MNB(E), UNMIK, OSCE, RAND, IDA, CNA, MITRE, Evidence Based Research, Cornwallis Group, George Mason University Peace Policy Institute, NDU/INSS, USIP, 353rd Civil Affairs, and many others.

A special thanks to BG Croom, USAF, EUCOM J6, and his Chief of the Current Operations and Contingency Branch, Lt Col Earl Matthews, USAF, for their support and help at the EUCOM level to get the insights and support for the visit to Kosovo. Many thanks go to Major Dan Cecil, USAF, a member of the EUCOM J6 Joint Operations Center and my military escort on the visit to Kosovo, for his efforts to get things in place for the trip to Task Force Falcon, including signing for my helmet and flack vest for the trip. I am in debt to BG Sanchez,

USA, the Commander of MNB(E) and Task Force Falcon, his Chief of Staff, Col Al Landry, USA, and Major Peter Jones, USA, of the G3 Plans shop for their support of my Kosovo visit and opening the doors necessary to make this a successful “quick look” into the lives of the soldiers on the ground, the day-to-day operation of Task Force Falcon (TFF) and challenges faced, and the things done to make a difference. Thanks for a job well done goes to 2LT Brendan Corbett, USA, of G3 Plans and the Task Force Falcon escort and person responsible for coordination of activities and making things happen (in addition to his many other duties assigned).

While in Kosovo and at Task Force Falcon, I owe a special thanks to many people but particularly LTC Tom Greco, G2, LTC Dave Hogg, G3, LTC Gary Beard, G5 and Civil Affairs, Major Jorge Rangle and Captain Davis, PSYOP, LTC Smith, Info Ops, LTC Kokinda, 121st Signal, Majors Harper and Lee, G6, Col McCully and Major Lin Crawford, 7th Signal, and Major Debra Allen, Public Affairs and to all of the members of “team Falcon” for showing me the ropes. Major Brown, USA, and Steve Seybert of the Land Information Warfare Activity Field Support Team were particularly helpful in gaining some first hand insights into the application of tactical Info Ops. Major Joe Irby, USA, LNO at KFOR helped facilitate visits to KFOR and Col Mike Dziedzic, USAF, the UNMIK strategic planner, helped organize visits to UNMIK, OSCE and the Humanitarian Community Information Center in Pristina.

Many thanks to those who labored through the review of the largest chapter in the book, Task Force Falcon: A Snapshot in Time. Colonel Al Landry, USA, Colonel Pat Capin, USA, Colonel Miles, USA, LTC Tom Greco, USA, LTC Gary Beard, USA, CPT Davis, USA, and Steve Seybert, LIWA, were extremely helpful in providing a reality check. There were others who made important contributions and opened doors, such as, Col Pat Nutz, USAF, Col Anne Leary, EUCOM, George Uriona, DISA-EUR, Col Mike Peterson, USAF/SC, Ev Johnson, USAREUR, Bob Gray, Danny Johnson and Paul Meaker at USAREUR/5th Signal Command, Joe Mroz, US Mission NATO, Herb Fallin and Rex Goad at NC3A-The Hague, Jim Wager, NC3A-Brussels, Bob Britton, MITRE, BG Schulz, NACOSA, LtCol Chuck Curran, CAOC, Col Sheets, USAFE/WPC, MSgt Dranchak, USAFE/SC, CAPT Joe Keane, USN, Col Glueck, Capt Gabrielle Chapin, and Capt Robert Denckhoff of the USMC/26th MEU, Tex Curran, ACS Services, and many others for whom I apologize for not including.

A special thanks to Margita Rushing, Bernie Pineau, Joseph Lewis, and Alison Leary of Evidence Based Research, Inc. Margita for her editorial work in putting the book into its final form, Bernie for his graphics support in designing the book cover and preparing the many photos and graphics for publication, and Joseph and Alison for their help in revising the story of my visit to Kosovo.

The photos in the book were taken from several sources. A majority were taken by me while in Kosovo and the rest from Combat Camera files and photos taken by Major Dan Cecil, USAF, and Captain A. Davis, USAR. The book cover is a photo I took while on mission with a Tactical PSYOP Team in the Kosovar Albanian town Zegra. The town had received substantial damage from Serb shelling during the conflict.

Finally, a special note of appreciation to my wife, Karen, for her support and for putting up with my seemingly endless weeks of travel that included 6 weeks in Kosovo during the summer of 2000, hours in front of the computer, the inconveniences, many lost weekends and quality time with her and the family—the book is dedicated to her and the family: Karen and Pat, Gregg, Mike, Mirella, Sharon, Justin, Chelsea, Nicole, Tom, Sue, and Evan.

PREFACE

History has demonstrated that the future will always be dangerous and although demographics, economics, and natural resources are predictive indicators of potential problem areas, asymmetric threat-related potential problem areas are not that easily predicted, making it more difficult to prepare for such events. As a result, the North Atlantic Treaty Organisation (NATO) needs to maintain a flexible, effective, and responsive command structure supported by flexible, deployable, interoperable, and adaptable forces of its member nations. NATO and its member nations will also need to effectively employ rapid advances in technology in order to collectively modernize their forces and command structures and to continue to be perceived by their potential adversaries as a credible deterrent force.

The NATO Alliance security challenges of the 21st century include regional instability, weapons of mass destruction proliferation, transnational threats (refugees, terrorism, criminal activities, environmental issues, and competition for resources), and failure of democracy and reform. The military mission of the Alliance is collective defense, peacekeeping, promoting expansion and stability, and defense against weapons of mass destruction. Since the fall of the Berlin Wall in 1990, NATO has been an Alliance in transformation. This transformation has included key initiatives such as:

- Revised Strategic Concept in 1991
- Engagement in Peace Support in 1992
- Partnership for Peace in 1994
- Combined Joint Task Force in 1996
- European Security and Defense Identity in 1996
- Relationships with Russia and Ukraine in 1997
- New Command Structure in 1998
- Enlargement, Revised Strategic Concept in 1999

These initiatives, along with proactive involvement in the Balkans, have transformed NATO from an organization mainly concerned with collective defense into a powerful player in the field of peace support in the European theater of operation.

The NATO Military Committee doctrine defines peace support operations to include conflict prevention, peacekeeping, humanitarian aid, peace enforcement, and peace building. Peace support operations tend to fall between Article 4 (consultation) and Article 5 (armed attack) of the North Atlantic Treaty. NATO use of military means to restore peace in an area of conflict would be in accordance with Chapter VII of the U.N. Charter. The NATO transformation to peace support operations introduced new military requirements and the need for a new doctrine. It forced the Alliance to start addressing issues such as impartiality, limits on the use of force, transparency of operations, and most importantly, civil-military coordination and cooperation. The purpose of the Combined Joint Task Force initiative was to improve NATO's ability to conduct complex peace support operations, and actions were initiated in the mid 1990s to begin improving the Alliance's military flexibility, mobility, and ability to rapidly deploy forces forward in support of such operations. The Balkans provided a sooner-than-expected live test of NATO's new doctrine, strategy, and evolving military capabilities, and many lessons have been learned and continue to be learned, but much remains to be done to build the NATO and national civil-military capabilities (including interoperable communications and information systems) necessary to meet the command and control demands of forward deployed Alliance forces involved in complex peace support operations.

The patterns of conflict for the post-Cold War environment are changing. The number of peace support and humanitarian operations requiring military intervention are increasing not only in frequency but also in complexity and situations involving human suffering. The traditional peace support operation environment where combatants signed an agreement in good faith and asked a world body like the United Nations (U.N.) to serve as a neutral observer have largely become a thing of the past. Many conflicts are now driven by the weakness of states rather than their strengths. Wars no longer take place between states that feel strong enough to conquer another, but rather within states that have become so weak they implode. "Wars of the Amateurs" occur where the state breaks down and the population

regroups into identifiable factions. Political groupings led by charismatic leaders play on minority fears and ancient grievances. Disintegration of law enforcement, the military, and other security forces occurs as well. The armed amateurs use the full range of conventional weapons for unconventional operations such as ethnic cleansing and scorched-earth actions.

New actors and expectations are challenging the traditional institutions supporting peace operations. Whereas earlier interventions were primarily military with possibly a small police contingent, more recent operations have involved larger police contingents and included relief and reconstruction teams, election supervision personnel, and multinational civil administration staffs as well. Instead of monitoring a cease-fire line, the intervention force is likely to have a much broader mandate. Actions are likely to include disarming belligerents and cantonment or destruction of their weapons, enforcing the rule of law, distribution, and protection of humanitarian aid, civil infrastructure reconstruction, nation building, assisting and protecting the resettlement of displaced persons, and arresting suspected war criminals. Although direct attacks against the intervening military have occurred, in most cases the military have been able to keep the attacks under reasonable control with limited casualties. On the other hand, non-military participants such as U.N. civilian employees, journalists, and NGOs are experiencing a rise in casualties in covering peace support operations. As a result, the need for a more integrated and cooperative civil-military involvement is on the rise in an operational environment that is becoming increasingly more difficult and dangerous for the peacekeepers and other participants.

In peace support operations, there are no clear front lines and rear areas. Instead, the front line is 360 degrees with fluid zones of conflict. Today's peace operation landscape is populated by a large number of different actors with their own agendas and there are those who will not be held accountable for their actions on the ground. The environment is complex and varied. There are wide extremes of weather and terrain, a mix of urban and rural, modern and primitive, and upscale and slum. Transportation routes are inadequate and massive problems arise from displaced persons and destroyed infrastructure such as roads, bridges, power, water, and telecommunications.

Understanding the relationships and motivators of the actors on the peace operations landscape requires an understanding of the complex

dynamics at work. The emerging need for stronger civil-military relationships and cooperation are influenced not only by the political context and conditions of the operations, but also by the shared moments of the participants on the ground. The decision to intervene in a conflict is political and the military mission in support of the intervention reflects the political process. Military support to such operations is just that, a military operation. The military are there to create a safe and secure environment. The military also provide assistance, as appropriate and necessary, to the International Organizations (IO) and Non-Governmental Organizations (NGO). They are, however, not there to do the jobs of these organizations—assumption of tasks beyond the agreed military mission is commonly referred to by the military as mission creep.

The complex peace support operations in the Balkans have employed U.S. military forces in both lead- and support-nation roles. For example, the United States provided the senior leadership for the IFOR and SFOR operations in Bosnia. In Kosovo, the United States played a lead-nation role for Operation Eagle Eye in support of the Kosovo Verification Mission and then led Task Force Noble Anvil in support of the NATO-led Operation Allied Force air war over Serbia. While supporting the air war, the U.S.-led Task Force Shining Hope provided humanitarian assistance in Albania in support of the NATO-led Operation Allied Harbour that provided humanitarian relief to Albanian refugees fleeing the province of Kosovo into Albanian and the Former Yugoslav Republic of Macedonia. For the most recent NATO-led operation, Kosovo Force (KFOR), the U.S. military found itself in a support-nation role and this introduced some interesting command and control challenges for the U.S. forces. The KFOR command arrangements were complex and the variety of stovepiped independent C4ISR systems deployed by NATO and the participating nations created security disconnects and interoperability and information sharing challenges that needed to be dealt with in real time in the operational environment.

The KFOR U.S.-led Multinational Brigade (East) was under the command of COMKFOR, a non-U.S. NATO commander. For example, the initial deployment of KFOR was under the command of the UK-led Allied Command Europe Rapid Reaction Corps (ARRC). With the transition of command from the ARRC to LANDCENT, a German commanded KFOR, and then with the transition to EUROCORPS, the commander was Spanish, and in the fall of 2000, with the transfer

of command to AFSOUTH, the commander KFOR was Italian. There were a number of non-U.S. national military elements assigned to MNB(E) and although MNB(E) was a multinational brigade, the command functioned mainly as a U.S. brigade with liaisons used to interface with assigned multinational units. By contrast, the other KFOR multinational brigades tended to operate as an integrated multinational command arrangement using non-lead nation officers in deputy commander and other key command-level positions. Operating in a support role as part of a multinational force was counterculture for the U.S. military. This required some difficult adjustments with each rotation of U.S. force elements. The United States was not in charge, and therefore it was no longer the Frank Sinatra do-it-my-way approach to doing business.

Information sharing is not a natural proclivity for many organizations and actors involved in coalition operations. Military and intelligence organizations are not accustomed to sharing data with international and non-governmental (NGO) organizations and vice versa. For operational security reasons, there is a continuing reluctance on the part of the military to share time-sensitive operational information with anyone other than military (especially multinational political bodies), and, even for military-to-military sharing, strict need-to-know rules are applied—it's a delicate balance between informing and operational security. Fears that data will be misused or that databases contain inaccuracies also militate against open information sharing. Even for military-to-military sharing, not all nations in a military coalition are treated as equals and many partners in today's peace operations were former enemies in the Cold War so there are differing need-to-know restrictions placed on sharing sensitive military-related information with them as well. NGOs and the media are concerned about maintaining the perception of neutrality and are therefore hesitant to work too closely with the military or be perceived as pawns of the military intelligence organizations in particular. In addition, they do not always share the same objectives and are suspicious of national government intentions. There is a need in peace support operations to bridge the trust gap and improve the ability to share information necessary to achieve both the civil and military needs without undermining the NGO and media neutrality—a fine line to walk, but one that can be walked if everyone is sensitive to each other's concerns. As a result, collaboration, coordination, and information sharing have

become important operational considerations that require real-time addressing by the civil-military actors on the ground.

The various NATO-led Kosovo operations have spanned the conflict spectrum from the air war to humanitarian assistance to peacekeeping and peace building. These operations represented a broad range of U.S. and NATO coalition command and control and C4ISR system challenges and presented some unique opportunities to gain real-world multinational force insights into asymmetric warfare and peace operation experiences and lessons. Operation Allied Force taught the European Allies, and the rest of the world, about U.S.-advanced C4ISR and weapon system capabilities and dependence on them in time of war. NATO and its member nations now more clearly realize the magnitude of the transatlantic technology gap and the reliance the United States places on the use of precision-guided weapons, satellite reconnaissance, and other advanced C4ISR technologies. Coalition partners were not equipped, nor were they trained, to fight in the same way as the United States in the air campaign and these differences required real-time training and innovative adjustments to overcome operational differences and limitations. While providing U.S. military support to SFOR in Bosnia and the air war over Serbia, the U.S. Army was directed to deploy Task Force Hawk, a brigade-sized combat arms team built around the Apache attack helicopter and multiple-launch rocket system, to Albania to conduct deep attack operations into Kosovo in support of the air war. The U.S. Air Force Europe (USAFE) was tasked to deploy a humanitarian assistance team, JTF Shining Hope, to Albania to deliver more than 3,400 tons of food, equipment, and medical supplies to the Kosovar refugees in Albania. The 26th Marine Expeditionary Unit was deployed to provide camp security for the USAFE operation. Headquarters for both of these operations were co-located (different sides of the airfield) at the Tiranas-Rinas airport and this created some U.S. command and control challenges since the commander who was in charge of the area of operation was never clearly defined. There was also duplication in the U.S.-provided communications and information services supporting the two operations.

During the air war, the era of the virtual commander and operations arrived. SACEUR (USCINCEUR) and his commanders and key staff were geographically dispersed throughout Europe and the UK and included CONUS-based commanders and staff as well. Targeting involved not only the targeteers but legal and political elements as well

who were geographically dispersed. Collaborative planning tools and simultaneous staffing were employed in order to meet the targeting process time lines. The U.S. strategy was to move functions and information—not the people—and the advanced C4ISR systems of the United States helped make this a reality. The senior U.S. commander's command and control systems of choice became U.S.-provided secure video teleconferencing, e-mail, and voice. NATO-provided secure video teleconferencing, e-mails, data networking, and voice became the means for tying multinational commanders and their staffs together and exchanging information. NATO secure voice and video teleconferencing also supported real-time political-military coordination activities with the NATO political leadership and national capitols. The NATO and U.S. secure data networks supported intelligence dissemination and collaborative planning for targeting and air tasking order preparation, approval, and dissemination. Video teleconferencing was used daily for decisionmaking, battle damage assessment review, and for communicating the commander's intent to his subordinate commanders. The senior commanders used both NATO and national e-mail systems for exchanging information and coordinating actions—it became the de facto formal messaging system. For the United States, the highly secure SIPRNET and JWICS data networks provided an ability to reach back to anywhere around the world to get access to the information and expertise necessary to meet mission intelligence and assessment needs.

BG Charlie Croom, USAF, and EUCOM J6, referred to Operation Allied Force and the subsequent KFOR operation as “The Age of the Video War” with the introduction of real-time UAV and P-3 video dissemination, handheld video camera, and digital camera dissemination, and the extensive use of video teleconferencing down to the tactical level in Kosovo. Video teleconferencing even supported MWR initiatives—a soldier on a mountaintop in Kosovo could have video teleconferencing with members of his family in Germany. Global TV with nightly news clips of NATO air strikes, including gun camera video, and live, on-the-scene reporting of NATO air strike battle damage assessment from Belgrade and Kosovo and human rights violations and refugee movements on the ground in Kosovo, Albania, and Macedonia created challenges for informing and setting political and public opinions and expectations as well as neutralizing the effects of Serbia's use of the public broadcast media for propaganda purposes. Internet with multimedia presentation Web sites was a major player as well. Perceptions and managing expectations needed careful addressing

by the military, especially in their dealings with the politicians and media and informing the public. Milosevic's propaganda actions were aimed at trying to divide the Alliance. The network of political-military information sharing established by NATO helped maintain the NATO Alliance unity of purpose throughout the air campaign.

Information operations came of age in the Balkans. The first-ever reported cyber attacks against Allied information systems were experienced. The new global awareness achieved through near real-time dissemination of information over the worldwide TV networks and the Internet placed increased demands on the military operations to share more timely information not only among the coalition forces but with the political structure, the media, and the population in general. The demands for information during the Kosovo air operation stressed the NATO and Allied military information networks to their limits and things did not get any better during the early phases of the Kosovo ground operation. In Kosovo, the KFOR truth project information campaign proved to be a major success in winning the support of the local populace. There were, however, some downside risks associated with more open sharing of operational information, especially during the air war. Releasing gun camera video showing the accuracy of precision weapons set public and political expectations that nothing can go wrong and had significant adverse public opinion and political reactions when something did go wrong such as the inadvertent bombing of a refugee convoy in Kosovo and the Chinese Embassy in Belgrade.

The NATO deployment into Kosovo presented a different set of challenges for the military. The roads were in disrepair and there were minefields everywhere. Unlike Bosnia, in Kosovo the civil infrastructure such as power, water, and telecommunications were not operating. The civil government was dysfunctional. The civil administration, law and order, and emergency services functions such as mayor, police chief, fire chief, and dial-911 services had to be temporarily assumed by the military. Emergency medical services needed to be restored. Bakeries and basic food services needed to be put back into operation to begin to help feed the people. There were criminal elements with whom the military had to deal. The Yugoslav military and Serbian special police (VJ/MUP) were not defeated on the battlefield so it was not clear if they intended to comply fully with the Military Technical Agreement. The UCK viewed itself as the liberating force and they were trying to fill the power vacuum left by

the VJ/MUP departure and become the Army of Kosovo. They had to be dealt with, including disarming them and transforming them into a U.S. FEMA-like organization to help rebuild the Kosovo infrastructure. The U.N. had to reinvent itself as the surrogate government even as it sought to build the capacity for local rule. In so doing, it became responsible for maintenance of law and order but without a legal framework to do so effectively. Ethnic revenge violence—drive-by shootings and bombings—conducted mainly by the Albanians against the Serbs put KFOR soldiers in harm's way. The media were everywhere during the early phases of the operation and had to be accommodated. There were more than 300 uncoordinated non-governmental organization personnel trying to help provided humanitarian assistance. Refugees were returning in mass and it was necessary to prepare shelters for them for the winter. It was a complex and confusing environment and an extremely difficult job to bring some order to the chaos.

Much has been and continues to be written about the effectiveness of NATO's strategy of diplomacy backed by credible force (coercive diplomacy) in prosecuting the air campaign against Serbia. A companion topic, the role of high-tech C4ISR systems and aerospace power in future conflicts has received considerable literary attention as well. Numerous PowerPoint briefings have mysteriously entered and propagated on the Internet touting the alleged strengths and weaknesses of the U.S. and NATO command and control capabilities employed during the air war. Little has emerged, however, about military land force involvement in peace support operations such as Operations Joint Endeavor and Guard in Bosnia and Operation Joint Guardian in Kosovo, which just happen to be the major role of the military today. The adequacy of training, equipping, and then recognizing and rewarding the military for their participation in such operations has been more openly debated in the military community, but funding improvements and more open recognition of contributions have not yet been elevated to comparable warfighting priority levels.

Although peace support operations are frequently just as dangerous as warfighting, they are not glamorous, do not command the same level of media attention, and hence, receive less literary attention to inform and document the experiences and lessons. The intent of this book is to illuminate some of the command and control, collaboration, and information sharing challenges of peace support operations in order

to help establish a more informed understanding of, and the need for, focused attention on resolving the civil-military cooperation issues related to multinational coalition operations and to bring attention to the need of providing NATO and its military improved command and control capabilities and C4ISR systems in order to more effectively support peace operations in the future.

SECTION 1—INTRODUCTION

CHAPTER I

Introduction

Larry Wentz

The ASD (C3I) Command and Control Research Program (CCRP) performs an important role in bringing an informed understanding of important issues to the attention of the DoD and International C4ISR communities and in conducting focused research of C4ISR issues of interest to this community. Its outreach program focuses on providing educational products that can be used by the professional military education program. These products are also used by the Service and Defense universities and colleges in their debates on real-world lessons and assessments of concepts for military support to future operations, especially peace operations such as those currently supported in the Balkans. CCRP research activities and publications can be found on the CCRP Web site at <http://www.dodccrp.org>.

Kosovo offered another unique opportunity for CCRP to do some coalition C4ISR-focused research in areas such as coalition command and control, civil-military cooperation, information assurance, C4ISR interoperability, and information operations. A Kosovo research effort was launched in the fall of 1999; however, because of limited resources, the CCRP-led study of lessons from Kosovo needed to be more focused and less extensive than the one conducted for Bosnia and needed to leverage to the maximum extent possible relevant ongoing lessons-learned activities. In regard to the latter, there was a need to quickly identify and assess the relevant ongoing lessons-learned activities in order to gain a better feel for their breadth and depth and how CCRP might be able to leverage and integrate the findings into its Kosovo study. It is also viewed important for CCRP to establish early on the appropriate collaboration, coordination, and cooperation arrangements with ongoing efforts as part of the overall study effort and to do so as soon as possible, including a visit to Kosovo to get some firsthand experiences.

There were a number of ongoing lessons-learned activities that were relevant to supplying the CCRP study with useful insights on experiences and early lessons. For example:

USEUCOM *Quick Look* and Follow-on Lessons Learned

Joint Staff *Noble Anvil Quick Look*

OSD *Report to Congress on Kosovo Lessons*

ASD (C3I) *Air War Flex Targeting Lessons*

ASD (C3I) *CCRP Lessons from Kosovo*

Defense Science Board *Kosovo Task Force*

USAFE/WPC/SA *Air War Over Serbia*

AC2ISRC *Kosovo Air Operations Lessons*

USAF *Kosovo Air Operations Lessons*

Center for Strategic and International Studies *The Lessons and Non-Lessons of the Air and Missile War in Kosovo*

Adm James Ellis, USN, *A View from the Top*

Air War College *Operation Allied Force Air Strategy Comments*

CSIS/USAF XP *The Lessons and Non-Lessons of the Air and Missile War in Kosovo*

Army/RAND *Kosovo Lessons*

ASD (C3I)/RAND *Use of Information in Kosovo Operations*

EUCOM Historian *Kosovo Database—General Officer E-mails and VTCs*

USAFE Warrior Preparation Center *Air War Database*

USAREUR *Quick Look* and *Kosovo Lessons Learned Team*

5th Signal Command *Task Force Hawk and Task Force Falcon Lessons*

Center for Army Lessons Learned *Task Force Hawk Lessons*

Navy/Marines/Center for Naval Analysis *Kosovo Lessons*

Marines Quantico Battle Lab (Emerald Express 99—Kosovo After Action Review)

Raytheon *Kosovo Lessons Learned Study Group Final Report*

National Defense University Institute for National Strategic Studies

SHAPE Joint Analysis Team

ARRC Lessons Learned

NATO RTO SAS-031 *Air Operations* Working Group

EUCOM J6 *Lessons from Kosovo* Report

USAFE/SC *Communications Supporting AFOR and JTF Shining Hope*

Army Magazine September 1999 issue

Marine Corps Gazette Magazine November/December 1999 issues

Task Force Falcon After Action Review

U.S. Army War College Kosovo After Action Review

In addition to the efforts noted above, the collection of Kosovo experiences and lessons also included participation in a number of U.S.- and NATO-led workshops that ranged from the air war to civil-military cooperation on the ground in Kosovo, extensive interviews of personnel who were there and those that supported them, a 6-week visit to Kosovo by the author and the support and dedication of military and civilian personnel who took the time to share experiences and lessons while in country and those who made additional contributions by documenting their experiences as chapters for this book.

Conflict in the Balkans

The NATO-led operations in the Balkans offered a unique opportunity to capture coalition command and control and C4ISR experiences and lessons for NATO and its member nation's first-time ever involvement in out-of-area peace operations and limited war. The operations also provide a unique opportunity to collect C4ISR experiences and lessons for U.S. forces operating as a member of a multinational coalition force that consisted of NATO alliance members, Partnership for Peace members, and other nations such as the Russians. In regard to the latter, an added challenge for NATO, and the United States in particular, was the fact that the Russians required special and different command arrangements for Bosnia and Kosovo. Their roles, missions, and participation differed for the two operations as well. The U.S. role in the Balkan operations has been as a lead nation and as a support nation and both of these roles introduced some unique and interesting coalition command arrangements, C4ISR systems interoperability, and information sharing challenges. The globalization of information, extensive use of data networks and information system services, extensive commercialization of military communications and information systems, introduction of advanced technology capabilities in an operational environment, and the introduction of coalition information operations were added challenges. NATO and its coalition members had to address these additional challenges in what was already a complex command and control and C4ISR environment.

NATO's Balkan operations started as a peace enforcement mission with the deployment of Implementation Force (IFOR) into Bosnia in December 1995, but transitioned quickly to a peacekeeping mission in the early phases of the IFOR operation. With the deployment of Stabilization Force (SFOR) in December 1996 and transfer of authority from IFOR to SFOR, the military operation continued mainly as a peacekeeping mission. Over time, however, the SFOR activities shifted in emphasis and now are largely a civil-military cooperation operation.

World attention began to refocus on Kosovo in 1998 when open conflict between Serbian military and police forces and Kosovar Albanian forces resulted in the deaths of thousands of Kosovar Albanians and forced hundreds of thousands of people from their homes. The international community became gravely concerned about the escalating conflict, its humanitarian consequences, and the risk of it spreading to other

neighboring countries. With the threat of NATO air strikes in late 1998, President Milosevic agreed to cooperate and bring an end to the violence. The U.N. Security Council Resolution 1199 set limits on the number of Serbian forces in Kosovo and scope of their operation and UNSCR 1203 endorsed two missions aimed at observing the cease-fire. The Organization for Security and Cooperation in Europe (OSCE) established and deployed a Kosovo Verification Mission (KVM) to observe compliance on the ground and NATO established and implemented an aerial surveillance mission, U.S. Operation Eagle Eye. In support of the OSCE, NATO also deployed the ARRC to Macedonia to assist with the emergency evacuation of members of the KVM if renewed conflict should put them at risk. The United States already had troops in Macedonia in support of the U.N.-sanctioned operation Task Force Able Sentry that was monitoring the Serbian border. The U.N. terminated the Able Sentry mission on 28 February and on 1 March operational control was transferred back to the United States to initiate the draw-down actions. On 28 March it was decided to modify the mission and rename the operation Task Force Sabre. The new mission was to maintain U.S. infrastructure in Macedonia that could be used as a forward staging and logistics area in case it became necessary for the United States to support a NATO-led deployment into Kosovo. On 22 April, operational control of Task Force Sabre was transferred to NATO.

Despite the U.N. and NATO efforts, the situation in Kosovo flared up again in early 1999. Renewed international mediation efforts in February and March at Rambouillet near Paris failed to get a Serbian delegation agreement and Serbian military and police forces stepped up their operations against the ethnic Albanians. Tens of thousands of people began to flee their homes. On 20 March, it became necessary to withdraw the OSCE KVM from Kosovo to Macedonia. Following several last-minute diplomatic efforts, the Secretary General NATO finally gave the order on 23 March to commence air strikes. The initiation of the NATO air strikes and a further escalation of ethnic cleansing by the Serbs resulted in massive movements of refugees into Albania, Macedonia, and Montenegro. International organizations (e.g., UNHCR and ICRC), non-governmental organizations, and NATO member nations, such as the United States, became engaged in a massive humanitarian assistance operation. The ARRC in Macedonia became involved in relief operations and constructing refugee camps. The ACE Mobile Force Land deployed Operation Allied Harbour into Albania in April to provide humanitarian assistance in support of, and in close coordination with, the UNHCR

and Albanian civil and military authorities. The U.S. deployed Task Force Shining Hope to support the Albania effort.

The Kosovo-related humanitarian assistance efforts introduced some interesting and somewhat unique command and control, integration, coordination, information sharing, and communication challenges. It is interesting to note that Secretary of Defense Cohen, Chairman of the Joint Staff General Shelton, and others became more public in their acknowledgement of the role the military needs to play in peace operations. As a result, humanitarian assistance and civil affairs activities and skills began to receive equal attention to warfighting skills.

With the start of air operations over Serbia and Kosovo in March 1999 under the NATO-led Allied Force, the Balkans operation took on a limited and short-lived wartime mission. In addition to supporting and leading the air operation, U.S. forces were also involved in humanitarian assistance and refugee operations in Albania and Macedonia. In Bosnia they continued to support SFOR peacekeeping and civil-military operations activities as well. The U.S. Army also deployed Task Force Hawk to Albania during this timeframe in preparation for possible use of the Apaches in support of the air operation and for a possible land operation into Kosovo. The 26th MEU was in Albania providing physical security protection for the USAF-managed refugee camp. After some 11 weeks of bombardment of Serbia and Kosovo, the air operation was suspended and the NATO-led ground force Kosovo Force (KFOR) deployed into Kosovo in June 1999 as a peace enforcement operation. Elements of U.S. Task Force Hawk (12th Aviation and an armored/mechanized task force from the 1st Armored Division's 1st Battalion) were relocated from Albania to Macedonia within hours after the Serbs accepted the terms to end the bombing and they, along with soldiers of the 82nd Airborne and the 26th Marine Expeditionary Unit, who were also relocated from Albania to Macedonia, formed the basis of the U.S. enabling force supporting the initial KFOR deployment. With the arrival in Kosovo, this force was named Task Force Falcon, the U.S. contingent of KFOR. The 2nd Brigade, 1st Infantry Division, deployed as the initial brigade-sized complement. Additional U.S. forces supporting Task Force Falcon were deployed from Europe and CONUS.

The United States was in the lead nation role for the IFOR, SFOR, and Allied Force operations. However, non-U.S. commanders led the

KFOR operation (initially the UK and then Germany, Spain, and finally Italy in the fall of 2000) with the United States in a support-nation role—a somewhat unique experience for the U.S. forces. This shift in role had interesting command arrangements, C4ISR systems and Services capabilities and interoperability, and information sharing implications that needed to be documented and understood in terms of implications for U.S. support in future coalition peace operations where the United States may not always have the lead-nation role.

There have been and there continues to be lessons-learned studies that capture pieces of the overall Bosnia and Kosovo story but none seem to be aimed at or charged with putting an integrated coherent Balkans coalition peace operation story together. The evolution of U.S. involvement in the Balkans is not being documented in a coherent manner either. In order to avoid lost experiences and lessons it is important to try to capture the U.S. and coalition experiences and lessons as they change over the course of events and missions supported. There are important experiences and lessons that need to be documented for not only each operation and its various phases but the transition between operations and the respective phases as well.

IFOR and the transition to SFOR were addressed by ASD (C3I) activities such as the CCRP-led Bosnia study and the resulting briefings, white papers, and CCRP-published books such as those noted earlier. These efforts looked at C4ISR experiences and lessons from NATO and national perspectives and included information operations and civil-military cooperation aspects as well. Other lessons learned reports from EUCOM, USAREUR, and the Center for Army Lessons Learned tended to look at the IFOR and SFOR operations from a CINC and Army perspective respectively. From a NATO perspective, the NATO Joint Analysis Team documented NATO experiences for the IFOR operation and some of aspects of the transition to SFOR. There has been little evidence of a coherent effort to tell the story and share experiences and lessons for the follow-on SFOR operation. Integration of the Kosovo Verification Mission (KVM), Allied Force, humanitarian assistance operations in Albania and Macedonia, and KFOR deployment experiences into an overall Balkans story does not appear to have been addressed.

There is a need to put a more coherent and integrated story together on military involvement in the Balkans. Such a story should not only

address Kosovo air operations, but also address the broader aspects and evolution of the Balkans operations that include IFOR, SFOR, KVM, Allied Force, humanitarian assistance in Albania and Macedonia, Task Force Hawk, KFOR, and other related operations. Command arrangements, C4ISR interoperability, intelligence operations, information sharing, information assurance, information operations, civil-military cooperation, humanitarian assistance, dealing with the media, and international policing are examples of coalition operational areas requiring more informed insights on what works and what does not work as NATO and participating nations' activities change over the course of their participation in these events.

This book attempts to look at some pieces that have not yet received high visibility. Limited resources did not permit a broader treatment of the events leading up to and including the air war and the ground operation in Kosovo. The principle focus of the book is on the follow-on civil-military operations related to the use of military forces in support of peace operations in Kosovo with some limited treatment of air war-related activities.

About the Book

The book is divided into six sections that cover five themes: Kosovo is not Bosnia; NATO use of aerospace power to project political will; managing media relationships; dimensions of civil-military operations; and coalition command and control of peace support operations including some firsthand observations from on the ground in Kosovo.

Section 1 is a prelude to the deployment of the NATO-led ground force, the Kosovo Force (KFOR). Since Kosovo is a land of contrasts and differs from Bosnia, examples of how Kosovo is not Bosnia are covered. The section ends with an introduction to UNMIK and KFOR including views of the successes and failures after 1 year of operation. Section 2 explores some of the ethnic and political differences that made the Kosovo experience unique from Bosnia and examines the effects of the arrival of UNMIK and KFOR on Kosovo's political evolution. The primary effort of the military in Kosovo was to create a safe and secure environment that ensured freedom of movement and supported open and free elections. After a little more than a year in country, UNMIK decided the conditions were met to conduct voter registration and to hold municipal elections to established a local

government administrative structure. A discussion of some of the civil-military activities leading up to the successful conduct of municipal elections in the fall of 2000 concludes this section.

Section 3 explores some of the operational challenges and frustrations related to waging the allied air campaign that supported the NATO-led air war over Serbia. In addition to conducting the offensive and combat air support operations over Europe, there was also an Alliance-led, large-scale humanitarian airlift operation ongoing at the same time and these air operations had to be deconflicted with civil aviation, placing added demands on the civil aviation air operations and urgent need for timely collaboration and cooperation. Some of the civil-military experiences related to dealing with EUROCONTROL and the civil air traffic authorities of affected nations are examined. During the air war, strategic intelligence was provided to the senior NATO political authorities by the NATO intelligence staff. This staff was not, however, trained or equipped for complex political-military crisis management and they struggled to cope with the demands of the high optempo military campaign that had major political and economic dimensions as well. A discussion of some of the challenges faced by the so-called “forgotten echelon” is presented. The inevitable gap between expectations and reality fueled much of the media’s anxieties regarding reporting on the air war and this section ends with a reflection of the NATO spokesperson and his dealings with the media and an examination of NATO and national media and public relations strategy and the ability of the NATO alliance to fight the so-called media war.

There were significant differences between the experiences, doctrines, responsibilities, and goals of the international humanitarian community and the military forces of KFOR that supported the armed humanitarian intervention in Kosovo. Furthermore, the civil (U.N., OSCE, EU, and NGOs) and military sides (NATO, KFOR, and national military) appeared to have spent little time prior to the operation attempting to understand how the other was motivated or how to operate together. The matter of mutual unintelligibility can be especially confusing, wasteful, and potentially dangerous, particularly if those differences are ignored during the planning stages of civil and military deployments to man-made political-military-humanitarian crises such as Kosovo. Section 4 examines the complexities of civil-military relationships, conflicts of the civil-military culture, and ambiguities of conducting international humanitarian operations. When KFOR entered Kosovo

there was no criminal justice system nor law and order and this section also examines some of the difficulties faced by KFOR to enforce basic law and order and to help UNMIK establish a criminal justice system to assume the law and order mission. In addition to KFOR troops, there were more than 650 separate international, non-governmental, and private volunteer organizations in Kosovo—an area the size of the U.S. state of Connecticut. The issue wasn't that there was not enough presence, but that they were uncoordinated. This section addresses some of the difficulties related to achieving unity of effort among the actors supporting peace operations. Information operations is being actively employed to help shape the environment in peace support operations—largely a trust and credibility information campaign. This is a new concept for most militaries and this section ends with a discussion of some of the coalition information operation challenges faced at the tactical level. The use of Task Force Falcon Kosovo experiences to influence the integration of information operations into U.S. Army tactical operations is examined as well.

There is a saying that in war, reporting stops when the military goes home and in peace operations, reporting stops when the media goes home. The story of military sacrifices and challenges of sustained peacekeeping operations rarely gets told and Section 5 is an attempt to tell a piece of the untold story. This section documents the on-the-ground, snapshot-in-time experience of the author's 6 weeks at Task Force Falcon and attempts to illuminate the challenges and difficulties faced by soldiers executing the peacekeeping mission. The demands for increased data services to support modern peacekeeping operations exceed the capabilities of today's military tactical systems, and therefore commercial products are being employed to enhance the military tactical system capabilities supporting the contingency operations. Commercialization of communications and information systems is also being used for sustained operations such as Joint Guardian in order to free up the limited military tactical asset for other possible contingencies. Modern information technology, such as the Internet and data networking, has been used to facilitate information sharing among the military for some time and now the non-military players are using such capabilities as well. Commercial products and services are being used more extensively by the civil organizations to support non-military needs. This section includes a discussion of the use of commercial products and services to support civil-military operational needs and, in particular, to support U.S. force deployments

in Kosovo and the challenges of commercializing the communications and information systems supporting MNB(E) sustained operations.

There are many more actors on the landscape of today's peace operations than have been present in the past. These actors have competing as well as common interests and expectations. The need to improve cooperation, coordination, and more open information sharing is increasing. Section 6 examines the challenges of achieving shared understandings and expectations and improved cooperation and coordination among the military and non-military participants. The section begins with a discussion of information sharing from a humanitarian assistance perspective and illustrates some of the substantial progress made in Kosovo by members of the non-military community, especially their use of Geographic Information Systems, Internet, and Web sites. Additionally, the idea of more open information sharing among actors supporting peace operations has been gaining favor for a number of years, but only recently has the technology become advanced, inexpensive, and widespread enough to make it feasible to be used by most non-military actors and this is discussed as well. The section ends with a broad discussion of cooperation, coordination, and information sharing challenges experienced by the military and civil participants in the Balkans peace support operations. The issues related to civil-military information sharing are covered and the use of commercial communications and information system capabilities to facilitate information sharing among the disparate players of peace operations is discussed as well. In the final analysis, however, information sharing is not a technology issue, it is an organization and political will issue. Technology is an enabler.

Finally, writing a book is certainly a unique adventure. I thought after my book *Lessons from Bosnia: The IFOR Experience* that I would never do another one again, but here I am. After more than a year of research and writing and twisting the arms of the other chapter contributors—who provided their inputs out of hide because of a personal interest to try to help make a difference—I am once again glad it is over. The words of Winston Churchill speaking in London on November 2, 1949, sum up my feelings.

Writing a book is an adventure. To begin with it is a toy and an amusement. Then it becomes a mistress, then it becomes a master, then it becomes a tyrant. The last phase is that just as you are

*about to be reconciled to your servitude, you kill
the monster, and fling him about to the public.*

I hope I meet the expectations of the reader. It certainly has been a wonderful but tiring adventure. The experiences and helpfulness of the people one meets cannot be adequately described in words. Who knows, I may revisit the Balkans or elsewhere sometime in the near future and once again paint a picture in words of a new experience.

CHAPTER II

Background

Larry Wentz

The province of Kosovo lies in the central part of the Balkan Peninsula in the southernmost part of Serbia. It is a landlocked area covering about 11,000 square kilometers. It is slightly smaller than the U.S. state of Connecticut and consists of two lowland areas separated and surrounded by highlands. The lowest terrain is in the west-central part of the province and the highest elevations (2,600 meter and over) are found in the west and southwest along the Albanian and Macedonian borders. The province is bordered by the remainder of Serbia from the northeast through the east, by the Former Yugoslav Republic of Macedonia (FYROM) on the southeast, Albania on the southwest, and Montenegro on the west. Pristina, the provincial capital and Kosovo's largest city, is approximately 240 kilometers south-southeast of Belgrade and 80 kilometers north-northwest of Skopje, FYROM. An ethnically mixed population of Albanians, Serbs, Romas, Turks, and Gypsies has inhabited the area for centuries. The estimated population of about 2 million people is overwhelmingly comprised of Albanians, about 90 percent. The province has the highest population density in the Balkans, 210 inhabitants per square kilometer. The average family size is seven. Poverty before the war was pervasive and remains so and the living standards are less than one-third the level of those in Serbia and Montenegro as a whole. The Albanians call Kosovo *Kosova* and the Serbs refer to the area as *Kosovo-Metohija* or *Kosmet*. The majority of Albanians are Muslims. Religions observed are Greek Orthodox and Roman Catholic. The Serbs are Serbian Orthodox Christians. The Albanians are believed to be descendents of Illyrians, the aboriginal inhabitants of the western Balkan Peninsula, who were compressed into their present-day mountain homeland and compact communities by the Slavs. The Serbs are Slavic.

NATO forces have been at the forefront of the humanitarian efforts to relieve the suffering of the many thousands of refugees forced to flee

Kosovo by the Serbian ethnic cleansing campaign. In the Former Republic of Macedonia and Albania, NATO troops built refugee camps, refugee reception centers, and emergency feeding stations, as well as moving many hundreds of tons of humanitarian aid to those in need. NATO also assisted the UNHCR with coordination of humanitarian aid flights as well as supplementing these flights by using aircraft from member countries. The Euro-Atlantic Disaster Response Coordination Center (EADRCC) established at NATO in May 1998 also played an important role in the coordination of support to UNHCR relief operations.

Of particular concern to NATO countries and to the international community as a whole, from the outset of the crisis, has been the situation of the Kosovar Albanians remaining in Kosovo, whose plight has been described by refugees leaving the province. All indications pointed to organized persecution involving mass executions; exploitation as human shields; rape; mass expulsions; burning and looting of homes and villages; destruction of crops and livestock; suppression of identity, origins, and property ownership by confiscation of documents; hunger, starvation and exhaustion; and many other abuses of human rights and international norms of civilized behavior. Cars and tractors were confiscated and prior to the Serbs departing Kosovo, vehicles were stripped of most working and valuable parts and left to rust along the border-crossing points.

Setting the Stage for Conflict

Until 1989, the Kosovo region enjoyed a high degree of autonomy within the former Yugoslavia even though the Albanians pressed for an elevation of the status of Kosovo to a republic within the federation. The conflict reached a new stage of intensity in 1989 when Serbian leader Slobodan Milosevic forcibly altered the status of the region, removing its autonomy and bringing it under the direct control of Belgrade, the Serbian capital. The entire structure of regional administration was dismantled and practically overnight Albanians were dismissed from their jobs, denied education in their own language, and exposed to massive abuse of their human rights and civil liberties. Kosovo became a de facto Serbian colony where 90 percent of the population was Albanian and 10 percent Serbs.

The Kosovar Albanians strenuously opposed the move. They organized a referendum and opted for independence. Led by Ibrahim

Rugova, they conducted a non-violent campaign to win their right to self-determination. In the hope that the international community would deliver a just solution, the Kosovars built a parallel society with certain instruments and institutions of local and sovereign authority. The policy of non-violence was not, however, rewarded either by the Serbian authorities or the international community. Despite many warnings that the conflict in Kosovo would escalate into open and armed conflict, no steps were taken to prevent it. The emergence of the guerrilla movement, the Kosovo Liberation Army (KLA) or *Ushtria Clirimtare E Kosoves* (UCK) in Albanian, was a predictable consequence. In June 1996, the KLA/UCK appeared publicly for the first time, assuming responsibility for a series of attacks against Serbian police stations in Kosovo. The KLA/UCK was not a unified military organization subordinated to a political party. Its strength, however, swelled from some 500 active members to a force of around 15,000. The KLA/UCK used mainly small arms to start with, but by 1998 its forces were armed with rocket propelled grenades, recoilless rifles, anti-aircraft machineguns, and mortars. During 1998, open conflict between Serbian military and police forces and Kosovar Albanian forces resulted in the deaths of over 1,500 Kosovar Albanians and forced 400,000 people from their homes. The international community became gravely concerned about the escalating conflict, its humanitarian consequences, and the risk of it spreading to other countries. President Milosevic's disregard for diplomatic efforts aimed at peacefully resolving the crisis and the destabilizing role of militant Kosovar Albanian forces was also of concern.

On 28 May 1998, the North Atlantic Council, meeting at Foreign Minister level, set out NATO's two major objectives with respect to the crisis in Kosovo, namely:

- help achieve a peaceful resolution of the crisis by contributing to the response of the international community; and
- promote stability and security in neighboring countries with particular emphasis on Albania and the Former Yugoslav Republic of Macedonia.

On 12 June 1998 the North Atlantic Council, meeting at Defense Minister level, asked for an assessment of possible further measures that NATO might take with regard to the developing Kosovo Crisis. This led to consideration of a large number of possible military options and on 13 October 1998, following a deterioration of the situation, the NATO

Council authorized Activation Orders for air strikes. This move (diplomacy backed by threat—persuade) was designed to support diplomatic efforts to persuade the Milosevic regime to withdraw forces from Kosovo, cooperate in bringing an end to the violence and facilitate the return of refugees to their homes. At the last moment, following further diplomatic initiatives including visits to Belgrade by NATO's Secretary General Solana, U.S. Envoys Holbrooke and Hill, the Chairman of NATO's Military Committee, General Naumann, and the Supreme Allied Commander Europe, General Clark, President Milosevic agreed to comply and the air strikes were called off.

U.N. Security Council Resolution (UNSCR 1199), among other things, expressed deep concern about the excessive use of force by Serbian security forces and the Yugoslav army, and called for a cease-fire by both parties to the conflict. In the spirit of the UNSCR, limits were set on the number of Serbian forces in Kosovo, and on the scope of their operations, following a separate agreement with Generals Naumann and Clark. It was agreed, in addition, that the Organization for Security and Cooperation in Europe (OSCE) would establish a Kosovo Verification Mission (KVM) to observe compliance on the ground and that NATO would establish an aerial surveillance mission. The establishment of the two missions was endorsed by U.N. Security Council Resolution 1203. Several non-NATO nations that participate in Partnership for Peace (PfP) agreed to contribute to the surveillance mission organized by NATO. In support of the OSCE, the Alliance established a special military task force to assist with the emergency evacuation of members of the KVM, if renewed conflict should put them at risk. This task force was deployed in the Former Yugoslav Republic of Macedonia (Turkey recognizes the Republic of Macedonia with its constitutional name) under the overall direction of NATO's Supreme Allied Commander Europe.

Despite these steps, the situation in Kosovo flared up again at the beginning of 1999 following a number of acts of provocation on both sides and the use of excessive and disproportionate force by the Serbian Army and Special Police. Some of these incidents were defused through the mediation efforts of the OSCE verifiers but in mid-January, the situation deteriorated further after escalation of the Serbian offensive against Kosovar Albanians and in particular, the massacre of 45 ethnic Albanian civilians in Racak. Renewed international efforts were made to give new political impetus to finding a peaceful solution to the

conflict. The six-nation Contact Group (France, Italy, Germany, Russia, United Kingdom and United States) established by the 1992 London Conference on the Former Yugoslavia met on 29 January. It was agreed to convene urgent negotiations between the parties in the conflict under international mediation.

NATO supported and reinforced the Contact Group efforts by agreeing on 30 January to the use of air strikes if required, and by issuing a warning to both sides in the conflict. These concerted initiatives culminated in initial negotiations between the two sides (KLA representatives led the fragmented Albanian political parties and Yugoslavia sent a delegation approved by its parliament) in Rambouillet near Paris, from 6 to 23 February, followed by a second round in Paris, from 15 to 18 March. At the end of the second round of talks, the Kosovar Albanian delegation signed the proposed peace agreement, but the talks broke up without a signature from the Serbian delegation. Many felt the agreement itself was very advantageous to the Kosovars (the agreement called for a *de facto* protectorate, something the Albanians had been asking for a long time) and hence, they had little problem signing it. On the other hand, the Serbs considered the deployment of NATO forces as an assault on their sovereignty and therefore, refused to sign the peace deal. Immediately afterwards, Serbian military and police forces stepped up the intensity of their operations against the ethnic Albanians in Kosovo, moving extra troops and tanks into the region in a clear breach of compliance with the October agreement. Tens of thousands of people began to flee their homes in the face of this systematic offensive.

NATO Takes Action

On 20 March, the OSCE Kosovo Verification Mission was withdrawn from the region, having faced obstruction from Serbian forces to the extent that they could no longer continue to fulfill their task. U.S. Ambassador Holbrooke then flew to Belgrade in a final attempt to persuade President Milosevic to stop attacks on the Kosovar Albanians or face imminent NATO air strikes. Milosevic refused to comply, and on 23 March the order was given to commence air strikes (Operation Allied Force).

From 24 March through 9 June NATO flew more than 38,000 sorties prosecuting the air war over Serbia. NATO's political objectives were to stop the killings in Kosovo, allow the refugees to safely return home,

and create conditions for a political settlement. From the outset, NATO planned to use aerospace power as a means to achieve its objectives while minimizing casualties among Alliance personnel and in targeted areas. Initially, U.S. national leaders and the North Atlantic Council prepared for a short conflict defined by limited objectives. This expectation of quick results shaped NATO and U.S. planning efforts. NATO forces began air operations over Serbia seeking to achieve air superiority and force Milosevic to cease aggression in Kosovo. While the initial attacks achieved tactical success, they did not have their desired political effect (diplomacy backed by force—coerce). NATO's effort grew in intensity until the end of the conflict. The U.S. Air Force, in support of NATO, flew 78 days of intensive aerial combat operations with the loss of only two manned aircraft and no casualties as a result of enemy action. It had committed resources and performed military operations at levels equivalent to a major theater war. The air campaign successfully allowed NATO to achieve its overall political objectives in the Serbian province of Kosovo. NATO's enduring strength, cohesion and resolve proved to be the most significant factors contributing to the successful prosecution of the air war.

During the Kosovo Crisis, highly charged political considerations precluded U.S. military planners from officially engaging in any ground campaign planning. Nonetheless, in April 1999 the U.S. Army Europe (USAREUR) was ordered to organize a force of ground support aircraft whose mission was to conduct deep attack operations into Kosovo in support of NATO's air campaign. This force was to strike at units of the Serbian Army, which were evading NATO air power in Kosovo because of political constraints, weather, terrain and enemy air defenses. The force, named Task Force Hawk (TF Hawk), was deployed to Albania and established its headquarters on the Tirana-Rinas Airport. TF HAWK was a brigade-sized combat arms team built around the Apache attack helicopter and the Army Multiple Launched Rocket System (MLRS). Organized by USAREUR, it was eventually turned over to NATO command and control in May 1999.

During the course of the NATO air campaign, international organizations estimated there were some 800,000 refugees who fled Kosovo into neighboring Albania and Macedonia. Several hundred thousand of these refugees fled to Macedonia alone and settled into camps just south of the Kosovo-Macedonia border. An estimated additional 590,000 were internally displaced. Together, these figures implied that over 90

percent of the Kosovar Albanian population had been displaced from their homes. An American Association for the Advancement of Science analysis suggested that the refugee flow patterns did not correlate positively with either the NATO bombing or mass killing patterns. The analysis concluded that the data did not support the theory that the refugees fled but was more consistent with the view that it was an organized expulsion.

The unprecedented influx of refugees into the Former Republic of Macedonia and the large number of ethnic Albanians forced from their homes and stranded in “no-man’s land” overwhelmed the combined capacities of the government in Skopje, the UNHCR and various relief agencies. At the request of the UNHCR, NATO forces in the Former Republic of Macedonia were put to work around the clock to build a number of refugee camps to its specification and then turned them over to the control of designated NGOs. In a matter of days four major refugee centers were up and running. NATO continued to provide certain essential technical support for reception and onward movement of aid cargo until such time that the necessary civilian support capabilities could be brought on-line. NATO countries also responded to the appeals from the UNHCR and the Skopje government by offering to provide temporary asylum for more than 110,000 Kosovar refugees. They provided aircraft to move more than 60,000 people to all 19-member countries. Partner countries also provided asylum for some 10,000 refugees.

In Albania, the refugee challenge was even greater. Operation Allied Harbour was NATO’s first humanitarian operation. Normally, such operations are almost exclusively the domain of civilian organizations, both international and non-governmental, but, in the case of the Kosovo crisis, by the end of March 1999 these agencies were unable to cope with the massive influx of refugees into Albania. Within a fortnight, over 200,000 refugees had arrived from Kosovo and NATO was the only organization quickly able to meet the expanding need. HQ AMF(L) was deployed within 5 days and much credit should be given to the nations and NATO HQs in deploying their forces and the augmentees so quickly. The soldiers and staff arrived on the run, setting to work within 24 hours of arrival, and within a few weeks, working closely with the civilian sector and the Albanian Government, the crisis was under control. Of course the crisis did not end there and by 15 June 1999 there were over 450,000 refugees in the country. But the provision by NATO of medical, engineer, transport, security, and staff support prevented

Milosevic from destabilizing Albania and proved instrumental in sustaining the refugees and in their eventual return to Kosovo.

In support of the NATO-led Operation Allied Harbour, Joint Task Force (JTF) Shining Hope, a USAFE-led operation, was established by USEUCOM on 4 April 1999 to help alleviate the suffering and provide immediate relief to more than 450,000 Kosovar refugees fleeing into Albania and the Macedonia. The JTF headquarters was located at the USAFE Warrior Preparation Center near Ramstein Air Base, Germany and orchestrated the humanitarian relief efforts through a small forward-deployed cell located in a series of tents on the Tirana-Rinas airport in Albania. The first U.S. built camp, named Camp Hope, opened on 12 May 1999 to accept the initial increment of Kosovar Albanian refugees. The 26th Marine Expeditionary Unit (MEU) provided security for Camp Hope. The United States worked closely with the UNHCR and other relief organizations to ensure a comprehensive and adequate response to the humanitarian crisis caused by the ethnic cleansing and atrocities that were conducted by Serbian forces. Never before had the U.S. military accepted such a massive humanitarian responsibility. During its first 50 days of operation, JTF Shining Hope delivered more than 3,400 tons of food, equipment, and medical supplies to those in need.

On 10 June 1999 NATO Secretary General Javier Solana announced that he had instructed General Wesley Clark, Supreme Allied Commander Europe, to temporarily suspend NATO's air operations against Yugoslavia. This decision was made after consultations with the North Atlantic Council and confirmation from General Clark that the full withdrawal of Yugoslav forces from Kosovo had begun. The withdrawal was in accordance with a Military-Technical Agreement (see Appendix A) concluded between NATO and the Federal Republic of Yugoslavia on the evening of 9 June. The agreement was signed by Lt. General Sir Michael Jackson, on behalf of NATO, and by Colonel General Svetozar Marjanovic of the Yugoslav Army and Lieutenant General Obrad Stevanovic of the Ministry of Internal Affairs, on behalf of the Governments of the Federal Republic of Yugoslavia and Republic of Serbia. The withdrawal was also consistent with the agreement between the Federal Republic of Yugoslavia and the European Union and Russian special envoys, President Ahtisaari of Finland and Mr. Victor Chernomyrdin, former Prime Minister of Russia, reached on 3 June.

The NATO Secretary General announced that he had written to the Secretary-General of the United Nations, Mr. Kofi Annan, and to the

President of the United Nations Security Council, informing them of these developments. The Secretary General of NATO urged all parties in the conflict to seize the opportunity for peace and called on them to comply with their obligations under the agreements that had now been concluded and under all relevant U.N. Security Council resolutions. Paying tribute to General Clark and to the forces which had contributed to Operation Allied Force, and to the cohesion and determination of all the Allies, the Secretary General stated that NATO was ready to undertake its new mission to bring the people back to their homes and to build a lasting and just peace in Kosovo.

On 10 June the U.N. Security Council passed a resolution (UNSCR 1244, see Appendix B) welcoming the acceptance by the Federal Republic of Yugoslavia of the principles on a political solution to the Kosovo crisis, including an immediate end to violence and a rapid withdrawal of its military, police, and paramilitary forces. The Resolution, adopted by a vote of 14 in favor and none against, with one abstention (China), announced the Security Council's decision to deploy international civil and security presences in Kosovo, under United Nations auspices.

Acting under Chapter VII of the U.N. Charter, the Security Council also decided that the political solution to the crisis would be based on the general principles adopted on 6 May by the Foreign Ministers of the Group of Seven industrialized countries and the Russian Federation - the Group of 8—and the principles contained in the paper presented in Belgrade by the President of Finland and the Special Representative of the Russian Federation which was accepted by the Government of the Federal Republic on 3 June. Both documents were included as annexes to the Resolution. The principles included, among others, an immediate and verifiable end to violence and repression in Kosovo; the withdrawal of the military, police, and paramilitary forces of the Federal Republic; deployment of effective international and security presences, with substantial NATO participation in the security presence and unified command and control; establishment of an interim administration; the safe and free return of all refugees; a political process providing for substantial self-government, as well as the demilitarization of the Kosovo Liberation Army (KLA); and a comprehensive approach to the economic development of the crisis region.

The Security Council authorized member states and relevant international organizations to establish the international security presence, and decided

that its responsibilities would include deterring renewed hostilities, demilitarizing the KLA and establishing a secure environment for the return of refugees in which the international civil presence could operate. The Security Council also authorized the U.N. Secretary-General to establish the international civil presence and requested him to appoint a Special Representative to control its implementation. Following the adoption of UNSCR 1244, General Jackson, acting on the instructions of the North Atlantic Council, made immediate preparations for the rapid deployment of the security force (Operation Joint Guardian), mandated by the United Nations Security Council.

The first NATO-led elements (force backed by diplomacy—seize and secure) entered Kosovo at 5 a.m. on 12 June. On this same day, a Russian convoy coming from SFOR, through Serbia, arrived at Pristina airport as well. As agreed in the Military Technical Agreement, the deployment of the security force—Kosovo Force (KFOR) - was synchronized with the departure of Serbian security forces from Kosovo that had started on 10 June. During the Kosovo entry, security capability was enhanced by the use of attack helicopters provided from Task Force Hawk. At 12 p.m. on 20 June, the Serbian withdrawal was completed (12 hours ahead of schedule) and KFOR was well established in Kosovo.

At its full strength KFOR would be comprised of some 50,000 personnel. It was a multinational force under unified command and control with substantial NATO participation. Agreement had been reached on the arrangements for participation by the Russian Federation. More than twelve other non-NATO nations also indicated their intention to contribute to KFOR. Also on 20 June, following confirmation by the Supreme Allied Commander Europe (SACEUR) that Serb security forces had vacated Kosovo, the Secretary General of NATO announced that, in accordance with the Military Technical Agreement, he had formally terminated the air campaign. On 21 June, the UCK undertaking of demilitarization and transformation was signed by COMKFOR and the Commander in Chief of the UCK (Mr. Hashim Thaci), moving KFOR into a new phase of enforcing the peace and supporting the implementation of a civil administration under the auspices of the United Nations.

The NATO-led KFOR command has undergone a number of changes since its arrival in Kosovo on 12 June 1999. The initial KFOR deployment was under the command of the Allied Command Europe Rapid Reaction Corps (ARRC) and headed by British Lt General Sir Michael Jackson.

General Jackson handed over the command to German General Klaus Reinhardt of Allied Land Forces Central Europe (LANDCENT) in October 1999. After 6 months, April 2000, General Reinhardt handed over the command to Spanish Lt General Juan Ortuno, commander of the five-nation European military force, EUROCORPS. EUROCORPS was originally a Franco-German initiative, but today it consists of soldiers from Belgium, Luxembourg and Spain as well as France and Germany. A 1993 agreement between SACEUR and EUROCORPS specified that EUROCORPS would adapt itself to NATO structures and procedures for rapid integration into NATO if necessary and this was the basis for its use in KFOR. EUROCORPS assumed command of KFOR and placed some of its staff in key KFOR positions but did not replace all of the NATO-nations staffed KFOR Headquarters' elements. In October 2000, command of KFOR was turned over to Italian Lt General Carlo Cabigiosu from Allied Forces Southern Europe (AFSOUTH). KFOR commanders all came under SACEUR who, up until May 2000, was U.S. Army General Wesley Clark and was replaced then by U.S. Air Force General Joseph Ralston.

Kosovo Is Not Bosnia

There are some similarities between Bosnia and Kosovo. Slobodan Milosevic was responsible for both calamities and the calamities were in the same general geographical and cultural areas. The violence directed against the ethnic Albanian civilians in Kosovo by Serbian paramilitary groups was indistinguishable from that directed against Bosniaks and Croats in Bosnia. Although there were important lessons learned in Bosnia, there were also significant differences between the two operations that precluded directly applying all lessons from Bosnia. Considering the application without understanding the Kosovo uniqueness could have had particularly dangerous results, a mindset sometimes referred to as preparing to fight the last war. Kosovo was not Bosnia and most likely never will be. Some of the Kosovo differences the military had to understand and deal with follows.

Bosnia was a historical sideshow for Serbs whereas Kosovo was center stage. Technically, Bosnia was independent when it became subject to Serbian interference, but Kosovo was still internationally recognized as part of Yugoslavia. Kosovo is the mystical heartland of Serbian nationalism. It is central to the Serbian people's perception of themselves

and lies at the heart of the Serbian military, religious, and economic history. Three of the greatest battles in Serbian history took place in Kosovo Polje (near Pristina the capital of Kosovo) and all were against the Islamic power of the time. The Serbian vision of themselves as warriors and the defenders of Christendom are rooted in Kosovo. The rise of the independent Serbian church began there in the late 1300s and three of the greatest monasteries in the church's history lie in Kosovo—Decani, Pec, and Gracnica. Economically, Kosovo has always been a source of raw materials and hard currency because of its mineral wealth. The Trepce mine complex north of Metrovica and its older and currently non-productive mine in Novo Brdo have been key drivers in the economy of the Former Republic of Yugoslavia for hundreds of years. As a result of its significant place in Serbian history, Kosovo was not just another province to be lost once again to the Islamic invaders, but rather a birthright for all Serbs.

Albanians living in Kosovo are culturally and socially similar to those living in Albania. They value their families and ethnic heritage, and personal honor is also important. A majority of Albanians honor a traditional institution called the *besa* (sworn truce). Adherence to the *besa*, family honor, hospitality, and a patriarchal order are considered the basis for successful relationships. In contrast to the situations in Croatia and Bosnia, little intermarriage has occurred between Serbs and Albanians in Kosovo. There are other Albanians who engaged in blood feuds, resisted governance by others, and distrusted outsiders. Among Albanians this behavior is referred to as the Kanun or Code of Lek Dukagjin (a system of customary law passed on through oral tradition through the centuries). The taking of blood for blood and head for head described in the code are only part of the numerous references regulating grazing rights, abandoned land, the hospitality extended to guests, the protection of religious property, and the working of mills and blacksmithies. The people of Kosovo have actively engaged in blood feuds for much of this century but unlike Montenegro and Albania, where the clan took vengeance, in Kosovo it was extended family (oldest male, usually the grandfather, resides as lord of the house and the household can extend to include second cousins) that was the main executor of retribution.

The international community did not view the conflict in Bosnia to be a catalytic war, but Kosovo was. All-out fighting in the province could have threatened to involve Albania and Montenegro to fracture

Macedonia, and possibly even involve Greece and Turkey. It, therefore, became necessary to be more careful about erring over Kosovo than was the case for Bosnia. A few NATO bombing runs helped bring Milosevic to the table over Bosnia in 1995 but this was not the case for Kosovo. Serbian capitulation only came after several months of a devastating bombing campaign that included not only Kosovo but also Serbia and the center of power, Belgrade. The Bosnian Serbs composed a motley and underpowered thuggery while the Yugoslav military (VJ and air defense) and paramilitary (MUP) posed a much more serious threat to both NATO air and ground forces. To Moscow, Kosovo looked uncomfortably like Chechnya and to Beijing a bit too much like Tibet. In Bosnia, NATO policy was in harmony with the professed aim of the Bosnian state: security and independence for a multiethnic democracy. NATO policy was not in harmony with either moderate or militant Albanians who demanded not a re-established autonomy, but independence. As a result, European allies and NATO were somewhat reluctant to intervene militarily without an enabling U.N. Security Council resolution.

Overall responsibility for the implementation of the civil and military tasks agreed in the Dayton Peace Agreement for Bosnia was divided between the Peace Implementation Council Steering Board (not a standing internationally recognized political organization) through the Office of the High Representative (OHR) and the North Atlantic Council (NAC) through the NATO chain of command. The OHR was tasked to coordinate the activities of the civilian organizations and to remain in close contact with the IFOR commander. Initially, no formal mechanism existed to develop the unified political direction necessary to synchronize civil and military policy between these two bodies, and this was a significant shortfall that had ramifications across all issue areas. For Kosovo, the United Nations Security Council Resolution (UNSCR) 1244 provided the political mandate including the role of the international security force. Specifically, UNSCR 1244 detailed the close relationship required between the civil authorities—United Nations Interim Administration Mission in Kosovo (UNMIK)—and the military authorities—Kosovo Force (KFOR). The resolution directed that the Special Representative of the Secretary-General (SRSG), Dr Bernard Kouchner, coordinate closely with the international security presence (KFOR) to ensure that both presences operated towards the same goals and in a mutually supportive manner. Commander KFOR made it clear to his forces that the success of KFOR was inextricably linked to the

success of UNMIK. An extremely close liaison was maintained between UNMIK and KFOR including daily meetings between the SRSG and COMKFOR and KFOR command level staff support to UNMIK and UNMIK liaisons with KFOR and the Multinational Brigades to facilitate planning, coordination, and information sharing.

Deployment of the NATO-led multinational Implementation Force (IFOR) into Bosnia was the culmination of years of international activity and negotiations to bring the warring parties to the negotiating table and to start the rebuilding process. Military deployment planning commenced more than two years prior to the Dayton Peace Accord being signed. The role of the military was to help the parties implement a peace accord to which they had freely agreed in an even-handed way. It was also believed that the warring factions were ready to quit fighting, at least for a while. Therefore, IFOR was not in Bosnia to fight a war or to impose a settlement on any of the parties. It was there to help create a safe and secure environment for civil and economic reconstruction. At the outset, the first task of the military was to separate the warring factions and create a Zone of Separation. The ZOS was 4 km wide, 2 km on either side of the agreed cease-fire line, between the Federation troops and the Bosnian Serbs. The second most important mission was to ensure that the former warring factions placed all units and equipment in designated barracks and cantonment areas. Following the successful separation of the forces, the military provided a secure environment to allow the rebuilding process to begin.

By contrast, in Kosovo KFOR primary tasks were to ensure the withdrawal of Yugoslav forces, establish law and order, establish a safe and secure environment, and demilitarize the Kosovo Liberation Army (KLA). The VJ and MUP withdrawal went without a major incident. There was no zone of separation in Kosovo, but a 25 kilometer wide Air Safety Zone and a 5 kilometer wide Ground Safety Zone were created that extend beyond the Kosovo province border and into the rest of the Former Republic of Yugoslavia. No military forces and equipment were allowed in this area, but verification over flight was permitted. In Bosnia, de facto partitioning occurred with the establishment of the Inter-Entity Boundary Line between the Federation and Serbian Republic and included the reunification of Sarajevo. In Kosovo, the major population groups were and still are mixed together and, while enclaves do exist, boundaries or security zones do not protect them. As a consequence, the ethnic populations mixed every day in a very

uneasy and tenuous truce. The Kosovo people were not war weary. Much of the population in Bosnia was tired of fighting after years of conflict. In Kosovo, the overt and truly violent conflict really only lasted less than a year and there was plenty of fight left in many of the former belligerents. Hence, a major challenge was keeping the lid on ethnic tensions and tackling crime. Demilitarization of the KLA was successfully implemented and it was transformed into the Kosovo Protection Corps (KPC), civilian emergency organization under the U.N. interim administration. Its 5,000 members have sworn to abide by the instructions of legal authorities, to respect human rights and to perform all duties without any ethnic, religious or racial bias. It was intended to be a multi-ethnic organization and Albanians, Roma, and Turks have joined, but no Serbs yet.

Unlike Bosnia, where French and UK forces were already in place as part of the U.N. Protection Force (UNPROFOR) and a U.N. communications infrastructure existed in country that could be and was used by deploying elements of IFOR, there were no Allied forces in Kosovo and no communications infrastructure to support the deployment. Fortunately, during the last weeks of May, NATO nations built up KFOR force levels in the former Yugoslav Republic of Macedonia in anticipation of a possible ground deployment. Successful resolution of the Kosovo conflict demanded that the departing VJ and MUP forces be followed closely by arriving KFOR ground forces in order to avoid a power vacuum in the cities and countryside where attacks and reprisals by Serbs and Albanians needed to be kept in check by threat of the use of military force. The KFOR intent was to hug the VJ and MUP as closely as possible during their withdraw.

Both Bosnia and Kosovo were multinational military operations and the respective countries were divided into sectors and a responsible lead-nation military was assigned to each sector under a single chain of command under the authority of a NATO commander. In Bosnia there were three sectors: North, Southeast, and Southwest. Multinational Divisions were assigned to each under Commander IFOR: MND (North) under the United States, MND Southeast under the French and MND Southwest under the UK. Kosovo was divided into five sectors and multinational brigades led by France, Germany, Italy, the UK, and the United States were assigned to each under Commander KFOR.

Serious challenges faced KFOR upon arrival in Kosovo. The threat of conventional conflict was very real. Yugoslav military forces were still present in large numbers. The VJ was not defeated on the battlefield and it was not clear if they intended to fully comply with the MTA requiring its peaceful and complete withdraw. Deploying KFOR forces had meeting engagements with withdrawing VJ operational forces, had convoys that intermixed and had to deal with a continuous stream of well-armed stragglers. The Kosovo Liberation Army (UCK), too, were well-armed and highly visible. They believed they won the war and ought to have a right to enjoy the fruits of their victory. Furthermore, the KLA(UCK) had its sights on becoming the Army of Kosovo, but KFOR had plans to disarm and demilitarize them. In fact, disarming some heavily armed KLA forces was necessary in earlier stages of the KFOR deployment. There were also splinter groups, the rogue warriors, who participated for personal gains that had to be dealt with. Fighting was still going on. There were far too few interpreters and linguists to help KFOR soldiers on the ground to deal with serious conflict situations. Sign language only goes so far in trying to deconflict fighting situations when one doesn't speak the language. Nearly a million people were refugees outside of Kosovo and many started to return in the middle of the KFOR deployment. Many of those who had remained in Kosovo lived in daily fear for their lives. Homes were destroyed, roads and fields mined, bridges down, schools and hospitals out of action. Radio and TV was off the air.

In Bosnia, even after years of civil war, there were still competent, functioning civil governments when IFOR deployed. In Kosovo there was no civil government, no law enforcement, no judicial system, no functioning banks, commerce was reduced to a barter system, and public services supporting transportation, water, power, telecommunications, and garbage collection were dysfunctional. Unemployment was widespread, exceeding 90 percent. Crime was flourishing. Ethnic violence and revenge killings were common occurrences. The military quickly found themselves in the position of becoming the mayor, fire chief, police chief, dial 911 emergency services, and any other role necessary to bring stability and law and order to the towns and areas occupied. Ordinary life in Kosovo was suspended. Visions of the Wild West, Roaring 20s, Mafia and Organized Crime, and City Gangs all come to mind when one thinks of the Kosovo ground environment of the NATO-led Operation Joint Guardian.

In Bosnia, establishment of the OHR and other international organization presences in country was significantly behind the NATO military force deployment. The OHR had to be created, funded, and staffed after the military had already arrived and was not given the overall authority that was required to direct and synthesize multiple civil and military actions. Furthermore, the OHR was not a U.N. Special Representative with U.N. authority and the United Nations was reluctant to play a lead role in Bosnia after its poor UNPROFOR experience. The NATO-led Implementation Force (IFOR) did not report to the OHR. IFOR reported to the North Atlantic Council (NAC) through the NATO chain of command and the OHR reported to the Peace Implementation Council Steering Board. Therefore, there was no internationally recognized political organization providing overall direction. This hampered synchronization of civil-military activities and actors operated autonomously within a loose framework of cooperation, but without a formal structure for developing unified policy.

In Kosovo, UNMIK tried to do better with the establishment of a four-pillar structure (UNHCR—Humanitarian Assistance; U.N. Civil Administration—Districts, UNIP, Judiciary; OSCE—Police Schools, Media, Elections; and EU—Reconstruction Investments) under its leadership, but this was a first-ever civil administration operation for them, procedures were not adequate to guide their actions and it was difficult to get qualified and experienced staff to fill key U.N. positions. Under the UNMIK construct, KFOR was employed to support the four-pillar structure by providing a safe and secure environment. The NATO-led KFOR had its own reporting chain and COMKFOR was not the U.N. Force Commander. Although KFOR proved not to be a paper tiger and the UNMIK approach showed good potential, there was a lack of a clear international vision and agreed strategy and plan for Kosovo. In some cases there was even a lack of UNMIK authority for directing and synchronizing activities of the civil-military actors and this added frustration.

For Kosovo, UNSCR 1244 gave KFOR full responsibility for Kosovo until the arrival of the U.N. Civil Authorities. KFOR provided law and order and began to rebuild the shattered infrastructure and prepare for a return to normalcy. KFOR troops cleared mines and unexploded munitions. Bridges, roads, and radio transmitters had to be repaired. Military engineers had to bring up the main Kosovo power station near Pristina, organize garbage collection, and generally restore vital community services with the priority being schools, hospitals, and

other public facilities such as power, water, and telecommunications. With the onset of winter in mind, emphasis had to be placed on repairing villages in the high mountains. These were not tasks ordinarily associated with classical soldiering. As a result, for both Bosnian and Kosovar operations, the military, in addition to providing security, had to fill gaps where there was an absence of credible civil agency capabilities to act and this raised expectations for continued military support for such actions (some times referred to as mission creep) and in some cases slowed the creation of the necessary civilian capabilities to meet the infrastructure reconstruction and nation-building needs.

Despite these frustrations and coordination challenges, including coordination of the efforts of over 250 non-governmental organizations (NGO) and an almost impenetrable tangle of international organizations jointly responsible for establishing a new civil order, the early collaborative efforts and close working relationship of UNMIK and KFOR resulted in some progress being made after 1 year, but achieving a stable civil administration in Kosovo remained a significant challenge.

Unlike the military that can act and react swiftly, thanks to its command structure, training, discipline, and capabilities on the ground, civil bureaucracies lack many of these qualities and capabilities and take far longer to act. UNMIK has begun to take over much of the work started by KFOR, most importantly the UNMIK police have begun to assume police responsibilities and have established and started training the civilian police, the Kosovo Police Service.

The end of one year of UNMIK presence complicated the civil administration situation in Kosovo due to the fact that at there was a pending turnover of some of the non-military organizations such as UNMIK police and U.N. Civil Administration staff. These changes could introduce continuity and coordination problems and loss of institutional knowledge that might add unneeded challenges to achieving and sustaining a stable operation. In Kosovo, UNMIK also suffered from an unusually high turnover of staff and lack of available skilled staff willing to fill key vacancies. The military exit strategy in Kosovo is directly tied to the success of UNMIK. Although some progress has been made to date, it has been limited and this suggests that the military and international organizations may be there for some time to come.

United Nations Interim Administration Mission in Kosovo (UNMIK)

The task before the international community is to help the people in Kosovo to rebuild their lives and heal the wounds of conflict.

—U.N. Secretary-General Kofi Annan

In Kosovo, the United Nations faced a sweeping undertaking that was unprecedented in its complexity and scope for any international institution. No other mission had ever been designed in which other multilateral organizations were full partners under United Nations leadership.

Mandate:

On 10 June, the Security Council authorized the Secretary-General to establish in Kosovo an interim international civilian administration under which the people of the war-ravaged province could enjoy substantial autonomy. The Council took its action by adopting resolution 1244 after NATO suspended its air operations following the withdrawal of security forces of the Federal Republic of Yugoslavia from Kosovo.

Two days later, Secretary-General Kofi Annan presented to the Council an operational concept of what since has come to be known as the *United Nations Interim Administration Mission in Kosovo (UNMIK)*. On 12 July, in his follow-up report to the Council, the Secretary-General presented a comprehensive framework of the U.N.-led international civil operation in Kosovo.

Tasks:

The Security Council vested authority in the U.N. mission over the territory and people of Kosovo, including all legislative and executive powers, as well as the administration of the judiciary. Never before had the United Nations assumed such broad, far-reaching, and important executive tasks. As the Secretary-General said, the United Nations will have an immense task of restoring a semblance of normal life to the province.

Among its key tasks, the mission was to:

- promote the establishment of substantial autonomy and self-government in Kosovo;

- perform basic civilian administrative functions;
- facilitate a political process to determine Kosovo's future status;
- support the reconstruction of key infrastructure and humanitarian and disaster relief;
- maintain civil law and order;
- promote human rights; and
- assure the safe and unimpeded return of all refugees and displaced persons to their homes in Kosovo.

Operational Framework:

In a massive international effort to turn war-devastated Kosovo into a functioning, democratic society, four international organizations and agencies would work together in one operation under the leadership of the Special Representative of the Secretary-General, Dr. Bernard Kouchner (France), who assumed office on 15 July. He took over from the Secretary-General's interim Special Representative, Mr. Sergio Vieira de Mello, who led the U.N.'s advance team to Kosovo to immediately establish a U.N. presence on the ground, assess the situation, and finalize an operational concept for the U.N. mission in Kosovo.

As chief of mission, Dr. Kouchner presided over the four sectors involved with implementing the civilian aspects of rehabilitating and reforming Kosovo.

Those sectors, also known as the four pillars, were:

- **civil administration**, under the United Nations itself;
- **humanitarian assistance**, led by the Office of the U.N. High Commissioner for Refugees;
- **democratization and institution-building**, led by the Organization for Security and Cooperation in Europe; and
- **economic reconstruction**, managed by the European Union.

General Strategy:

The work of UNMIK was to be conducted in five integrated phases:

Phase I—The mission will set up administrative structures, deploy international civilian police, provide emergency assistance for returning refugees and displaced people, restore public services and train local police and judiciary. It will also develop a phased economic recovery plan and seek to establish a self-sustaining economy.

Phase II—The focus will be on administration of social services and utilities, and consolidation of the rule of law. Administration of such sectors as health and education could be transferred to local and possibly regional authorities. Preparation for elections will begin.

Phase III—UNMIK will finalize preparations and conduct elections for a Kosovo Transitional Authority.

Phase IV—UNMIK will help Kosovo’s elected representatives organize and set up provisional institutions for democratic and autonomous self-government. As these are established, UNMIK will transfer its remaining administrative responsibilities while supporting the consolidation of Kosovo’s provisional institutions.

Phase V—This concluding phase will depend on a final settlement of the status of Kosovo. UNMIK will oversee the transfer of authority from Kosovo’s provisional institutions to institutions established under a political settlement.

Kosovo Force (KFOR)

KFOR consisted of 50,000 men and women. Nearly 42,500 were from over 30 countries and deployed in Kosovo and another 7,500 provided rear support through contingents based in the Former Yugoslav Republic of Macedonia, in Albania, and in Greece. KFOR contingents were grouped into five multinational brigades and a lead nation designated for each multinational brigade. Although brigades were responsible for a specific area of operation, they all fell under a single chain of command under the authority of Command KFOR. This meant that all national contingents pursued the same objective to maintain a secure environment in Kosovo. They did so with professionalism and in an even-handed manner towards all ethnic groups.

In accordance with UNSCR 1244, the mission of KFOR was to:

Establish and maintain a secure environment in Kosovo, including public safety and order:

KFOR had the mandate to enforce law and order until the U.N. mission in Kosovo could fully assume this responsibility. This was achieved by patrols, air surveillance, checkpoints, responses to emergency calls, search operations, border control, investigation of criminal activities, and arrest or detention of suspected criminals. After just 3 months in Kosovo, KFOR troops arrested hundreds of suspected criminals, confiscated weapons and ammunition, and restored the overall security and stability of the province. KFOR presence allowed more than 775,000 refugees and displaced people to come back into Kosovo and feel secure again. A constant drop in the rate of murder, arson, and looting signaled a potential return to normal life might not be far ahead. Special attention was paid to the protection of minorities, who were often the victims of ethnic tensions and hatred.

Monitor, verify, and when necessary, enforce compliance with the conditions of the Military Technical Agreement and the UCK undertaking.

KFOR was actively involved in the demilitarization of Kosovo. With the arrival of KFOR, military and police forces from the Federal Republic of Yugoslavia completed their withdrawal and met the final timelines of the Military Technical Agreement. Also KLA forces were compliant with the terms of the Undertaking of Demilitarization and Transformation. This Undertaking was a voluntary commitment for immediate cessation of hostilities and for a step-by-step demilitarization of the KLA, which was completed on 20 September 1999. Tons of weapons and ammunition were seized or handed to KFOR. These included thousands of pistols and rifles, hand grenades, anti-personnel mines, rocket launchers, artillery pieces, mortar bombs, rifle bombs, anti-tank mines, fuses, explosives, and even anti-tank rockets and missiles. The KLA was disbanded and all KLA weapons stored in secure weapons storage sites under the control of KFOR. The transformation of the former KLA was underway through resettlement programs, the creation of the Kosovo Police Service, and the stand-up of the Kosovo Protection Corps, which was to be an unarmed civil relief organization involved in the rebuilding of Kosovo's infrastructure.

Provide assistance to the UNMIK, including core civil functions until they are transferred to UNMIK.

KFOR and UNMIK were partners in an international effort to restore Kosovo and help the local population to transform the province into a free and democratic society open to all. Although KFOR's main responsibility was to create a secure environment, the multinational force provided resources, skills, and manpower to various organizations and agencies working under the UNMIK umbrella. Examples of KFOR involvement can be found in a variety of sectors such as: public works and utilities, construction, transportation, railway operations, mine clearance, border security, fire services, protection of international workers, food distribution, removal of unexploded ordnance, mine-awareness education, medical services, etc.

Nations Contributing to KFOR (KFOR HQ, Pristina)

Kosovo was divided into five sectors and a lead nation from the members of the NATO alliance was assigned responsibility for each sector. For each sector, a Multinational Brigade (MNB) was established under Commander KFOR. The United States was responsible for MNB (East), the French for MNB (North), the Italians for MNB (West), the Germans for MNB (South) and the British for MNB (Central). Nations contributing troops in support of KFOR and the MNBs were as follows:

NATO Nations

- Belgium
- Canada
- Czech Republic
- Denmark
- France (MNB-North HQ, Mitrovica)
- Germany (MNB-South HQ, Prizren))
- Greece
- Hungary
- Iceland
- Italy (MNB-West HQ, Pec)
- Luxembourg

The Netherlands
Norway
Poland
Portugal
Spain
Turkey
United Kingdom (MNB-Central HQ, Pristina)
United States (MNB-East HQ, Urosevac)

Non-NATO Nations

Argentina
Austria
Azerbaijan
Bulgaria
Estonia
Finland
Georgia
Ireland
Jordan
Lithuania
Morocco
Russia (North)—Russia (East)
Slovakia
Slovenia
Sweden
Switzerland
Ukraine
United Arab Emirates (North)—United Arab Emirates (East)

On the basis of the MTA and UNSCR 1244 agreement, the Greek Governmental Council on Foreign Policy and National Defense met on 11 June 1999 and decided to send a Hellenic Contingent of brigade level (34 Mech. BDE), in the framework of Operation Joint Guardian, under the name of GFSU (Greek Force Support Unit) whose task would be to create a safe environment for the inhabitants of Kosovo and to secure the safe return of refugees and those expelled. The tasks of the GFSU were as follows:

- Monitor, verify, and enforce as necessary the provisions of the Military Technical Agreement in order to secure a safe and secure environment;
- Establish and support the resumption of core civil functions;
- Provide combat support and combat service support throughout the KFOR area of operation in order to facilitate COMKFOR's mission;
- Assist in the movement and destruction of confiscated weapons, including EOD support;
- Assist UNMIK in the reestablishment of civil infrastructure;
- Provide response to traffic accidents and incidents;
- Provide convoy escorts as directed; and
- Perform medical exams and evacuation to population of Kosovo.

As a result of the successes achieved in Bosnia, a Multinational Specialized Unit (MSU) was assigned to COMKFOR and elements to his MNBs. The MSU is a military police force. The MSU in KFOR consists of a Regiment of Italian Carabinieri and a Platoon of Astonian Army. The MSU elements from the Italian Carabinieri have substantial experience in combating organized crime and terrorism. The MSU possesses human resource and dedicated investigative tools to analyze subversive and criminal organizations structure and provides prevention and repression resources to be used as a KFOR asset. MSU conduct general patrolling operations in order to maintain a regular presence within the KFOR AOR. Such operations are in support of KFOR routine patrol activity and allow the MSU to interact with the local community while deepening their overall knowledge of evolving criminal and security assets of each area. Each detachment in the KFOR AOR has a different strength depending on the public order and security situation of the area. The primary tasks of the MSU are:

- Maintenance of a secure environment;
- Law enforcement;
- Information gathering;

- Presence patrol;
- Civil disturbance operations;
- Counterterrorism; and
- Criminal intelligence on organized crime.

KFOR Headquarters Rear in the Former Yugoslav Republic of Macedonia has its Headquarters at the *Gazella* Shoe Factory in the capital Skopje. Headquarters Rear is responsible for sustaining the so-called Communications Zone (COMMZ) in the KFOR theater rear area. The KFOR COMMZ area of responsibility encompasses the sovereign independent nations FYR of Macedonia, Greece (COMMZ South), Albania (COMMZ West), and, to a certain extent, Bulgaria (COMMZ East). Personnel from 17 nations are present in the HQ Rear in Skopje. Seventeen of the 39 participating nations in Kosovo have National Support Elements (NSE) south of the border. There are approximately 4,000 troops in the FYR of Macedonia. The main mission of the headquarters is the reception, staging, onward movement, and integration of KFOR contingents moving through the COMMZ. KFOR Headquarters Rear is also the primary point of contact for the respective National Support Elements. At times, 1,000 military vehicles per day can cross the respective national borders in convoys.

KFOR is very aware of the fact that they are guests in the FYR of Macedonia and in Albania and therefore, cooperation and collaboration with the national authorities has highest priority. NATO has a liaison office in Skopje and has formed several working groups between KFOR and the host nation to address border issues, customs, and environmental protection issues. In regard to the latter, KFOR has concerns about environmental protection and continuous attempts are made to minimize the impact of operations on the environment or the local infrastructure. In such cases in which an impact on the environment was unavoidable and damages were caused, KFOR does its utmost to restore the environment to its original state or to compensate the host nation for damages. KFOR spends between \$500,000 and \$1 million (U.S.) per day in the FYR of Macedonia to purchase food, supplies, and services for the troops in Kosovo. The Headquarters Rear and the National Elements employ approximately 230 local civilians. Additionally, the guest nations donate to a variety of purposes and KFOR troops provide assistance in schools and participate in local community projects. KFOR Rear's Civil-Military Cooperation (CIMIC) branch is

involved in a multitude of projects in close cooperation with the leaders in villages, schools and other institutions.

UNMIK and KFOR Successes and Failures After 1 Year

On 12 June 1999, KFOR arrived in the province where at least 900,000 people, mostly Kosovo Albanians, had either been evicted, or had fled in fear for their lives. Tens of thousands of Albanians were feared dead. Most cities, such as Pristina the capital, were ghost towns. The civil structures, economy, and administrative services were dysfunctional and there was no law and order. A lot has changed in a year and despite setbacks, lack of hope, and challenges for the future, UNMIK and KFOR can claim some accomplishments and successes in this war torn province. The United Nations Special Representative Bernard Kouchner stated at a 1-year anniversary press conference, “The Kosovo mission is a success....Technically, politically, in terms of administration, in terms of human rights, in terms of protection, we have achieved a lot.”

Under KFOR’s protection, the vast majority of Albanians have been able to return, albeit at a speed and in numbers much greater than predicted. The VJ/MUP forces withdrew without major incidents, although some looting and burning took place as they left. However, neither KFOR nor the United Nations anticipated the level of revenge violence against remaining Serbs that would accompany the return of Albanian refugees to Kosovo. The flow of ethnic cleansing suddenly reversed and KFOR priorities had to be shifted quickly towards the protection of minorities and prevention of reprisals. To prevent attacks, or acts of revenge, KFOR increased the number of troops on the ground at any one time. For example, in Multinational Brigade East alone, 190 security patrols were mounted every day, 65 checkpoints were manned and 64 facilities, such as Serbian patrimonial sites, were guarded. The growing UNMIK police presence throughout the province also helped to deter violence and maintain law and order. As a result of KFOR and UNMIK efforts, security improved in general but remained a significant challenge in the Serbian areas where KFOR continued to provide 24-hours-a-day, 7-days-a-week protection. UNMIK and KFOR continue to focus on trying to make the Serbs feel safe in Kosovo and to

encourage others who left the province to come back. Few Serbs have returned but efforts continue to be pursued to facilitate more returns.

Since KFOR arrival, the KLA has been demilitarized and transformed. Its former members are now contributing to the rebuilding of Kosovo as civilians, through their participation in the Kosovo Police Service or in the provisional Kosovo Protection Corps. In addition to the thousands of weapons voluntarily handed over as part of the demilitarization process, over 12,000 illegally held weapons have been confiscated and are now in the process of being destroyed. Some of the former illegal weapons owners are in custody and the amnesty campaign currently ongoing has resulted in many more weapons being voluntarily surrendered.

UNMIK alone employs some 70,000 local public workers and KFOR and contractors such as Brown and Root who support MNB(E) also employ a large number of locals. In fact, Brown and Root may be the largest company employing locals. It has been estimated that about 500,000 students have returned to school, many being ethnic Albanians who had not been allowed to attend classes for a decade. Reconstruction of political and financial structure was under way as well.

When KFOR arrived, there were an estimated 40,000 land mines in the province, laid either by Yugoslav forces or the KLA. KFOR Explosive Ordnance Disposal (EOD) teams cleared mines from all the major routes and population centers, and also marked the remaining sites known to contain mines or other unexploded ordnance. Mines and unexploded ordnance were cleared from more than 16,000 homes, 1,200 schools, and 1,200 miles of road. KFOR ran an extensive mine awareness campaign in the media and through visits to local schools. The work done by KFOR EOD was not without risk and unfortunately, it has taken its toll—two KFOR EOD personnel have lost their lives and three have been injured in clearing the mines.

Crime was out of control on the streets when KFOR arrived. UNMIK police crime statistics show a huge decline since the KFOR and UNMIK police arrived. There has been a decrease in murders, arson, kidnappings, and looting. Murder rates of about 50 per week have been reduced to an average of 6 per week.

In many other areas, KFOR has provided support to UNMIK and NGOs through its involvement in reconstruction and humanitarian projects.

KFOR has built or repaired 200 km of roads and reconstructed or repaired 6 major bridges. Key infrastructure such as schools and utilities have been repaired and brought back into service. KFOR doctors and other medical specialists have treated approximately 50,000 local patients and 13 military field hospitals have been set up. KFOR assisted UNMIK in importing and distributing humanitarian aid, including food, clothing, and building materials for houses. Key to this effort was the restoration of the region's aging power plant near Pristina and the province's transportation system, including the reopening of Pristina airport and starting to get the rail system working again through the repair of hundreds of miles of railroad.

The presence of crowds of people, largely Albanians, walking safely on the streets, doing their daily business or shopping, or simply buying a local newspaper printed without censorship, provides further testament to UNMIK and KFOR achievements. However, in spite of these positive accomplishments and the presence of KFOR soldiers, the international community has failed to stop a new wave of ethnic cleansing in Kosovo. In fear of reprisals and their safety, the intellectual Serbs left during the air war and many of the other Serbs left as the Yugoslav army pulled out of Kosovo and none have returned. After the summer of 1999 less than half of the pre-air war Serbian population was left in Kosovo. The approximately 100,000 remaining Serbs lived in enclaves or divided cities and as noted earlier, were protected 24 hours a day, 7 days a week by KFOR soldiers. Moderate Serbian leaders, such as Bishop Artemije, President of the Serbian National Council of Kosovo, has reported that during the first year of the KFOR operation more than 1,000 Serbs have been killed, some 1,200 have been kidnapped or disappeared, over 10,000 Serbian homes have been destroyed, some 80 Serbian churches have been destroyed, and the violence against Serbs continues. Serbs have been expelled from firms and institutions where they worked and the Albanians control the education and medical system. The Serbs no longer have freedom of movement and their civil and human rights have essentially been taken away. Although the violence and attacks against Serbs has decreased somewhat, it has not ceased. The remaining Serbs are barely surviving and there is a fear that they will eventually disappear from Kosovo.

A lot remains to be done, especially in restoring human rights and providing freedom of movement and opportunities for the Serbs. The violence must end before the peace process can move forward. KFOR

can only try to provide a secure and safe environment. Real peace must be built by the people in Kosovo themselves. Mutual acceptance of the different ethnic groups is key to the future.

References

- Allied Forces South. <http://www.afsouth.nato.int/>
- BBC News (Kosovo: One Year On). <http://news.bbc.co.uk>
- Clark, Howard, 2000. *Civil Resistance in Kosovo*. Pluto Press, Sterling, Va.
- EUCOM J6 Report, 2000. *A United States European Command J6 Perspective of the Kosovo Crisis*. USEUCOM Headquarters Patch Barracks Vaihingen, Germany.
- Hesser, Fran, 2000. *Kosovo Prospectives for Peace Journal*. Web site: www.cnn.com
- Humanitarian Community Information Center. <http://www.reliefweb.int/hcic/>
- Janes Defense Weekly, 22 March 2000.
- KFOR Online Homepage. <http://kforonline.com>
- NATO NATIONS, January 2000. *K/SFORce for Peace*. Monch Publishing Group Bonn, Germany.
- NATO Review, Summer 1999, Autumn 1999, Summer-Autumn 2000. *Articles on Kosovo operation*. NATO Office of Press and Information Brussels, Belgium.
- NATO Official Homepage. <http://www.nato.int/>
- NATO Basic Fact Sheet [NATO's Role in Relation to the Conflict in Kosovo]. <http://www.nato.int/docu/facts/2000/kosovo.htm>
- OSCE (Organisation for Security and Co-operation in Europe) Homepage. <http://www.osce.org/>
- OSCE Mission in Kosovo. <http://www.osce.org/kosovo/>

OSCE Background Paper on Human Rights In Kosovo—As Seen, As Told. <http://www.osce.org/kosovo/reports/hr/index.htm>

Public Broadcasting Service (Frontline). <http://www.pbs.org>

Peace Pledge Institute, 2000. *Kosovo Conflict Background*. Web site: www.ppu.org.uk

Schnabel, Albrecht and Thakur, Ramesh, 2000, *Kosovo and the Challenge of Humanitarian Intervention*. United Nations University Press.

SHAPE Headquarters. <http://www.shape.nato.int/>

Task Force Falcon Online Homepage. <http://www.tffalcon.hqusareur.army.mil/home.htm>

Text of the Rambouillet Accords [U.S. State Department]. <http://www.state.gov/www/regions/eur>

Text of the Military Technical Agreement—9 June 1999. <http://www.nato.int/kosovo/docu/a990609a.htm>

U.S. European Command. <http://www.eucom.mil/>

UNMIK (United Nations Interim Administration Mission in Kosovo) Homepage. <http://www.un.org/peace/kosovo/pages/kobanner.htm>

UNHCR (United Nations High Commissioner for Refugees) Kosovo Crisis Update Homepage. <http://www.unhcr.ch/news/media/kosovo.htm>

UNSCR 1244 United Nations Security Council Resolution 1124, 10 June 1999. <http://www.un.org/Docs/scres/1999/99sc1244.htm>

U.S. Institute of Peace. <http://www.usip.org>

Washington Post. <http://www.washingtonpost.com>

SECTION 2—POLITICAL DIMENSIONS

CHAPTER III

Kosovo and Bosnia: Different Products of Yugoslavia's Disintegration

Jusuf Fuduli

In June 1999 an international peacekeeping mission known as Kosovo Force (KFOR) along with a United Nations civil mission were deployed to the formerly autonomous Serbian province of Kosovo. This mission marks the second time that the North Atlantic Treaty Organization (NATO) has been the vanguard of a non-U.N.-led peacekeeping force in the territory of the former Yugoslavia. The deployment of a NATO led peace Implementation Force (IFOR) to the former Yugoslav republic of Bosnia in December of 1995 began the start of large-scale operations in the Balkan peninsula with no end date established. These facts have lead many to conclude that both the mission to Bosnia and Kosovo are essentially no different from one another and that applying the experience obtained from the first mission will lead to success in the second. This assumption is erroneous. Bosnia and Kosovo represent very different situations that have evolved from separate histories and demand specific approaches in order for stability and peace to be achieved. While the conflicts in Bosnia and Kosovo share similarities, both are products of Yugoslavia's disintegration and have suffered from Serbian aggression, there are several pronounced differences that make the Kosovo experience unique from the Bosnian one.

These include the ethnicities of the people involved, their proportion of the total population, the status of these entities as federal units in the former Yugoslavia, and the relations between the inhabitants before open conflict erupted. In terms of political definitions, the most pronounced differences between Bosnia and Kosovo are the political statuses afforded to each. While both Bosnia and Kosovo are subject to international oversight and the presence of an international

peacekeeping force, the fact is that Bosnia requires an international mission to preserve its status as an independent state. This political status originates in its current form from the peace agreement known as the Dayton Accords signed in 1995 by the interested parties in the Bosnian conflict. Essentially, the peacekeeping mission in Bosnia will be required until the cement mixed at Dayton dries. Kosovo, unlike Bosnia, is not an example of a military solution being implemented to augment a political one. In Kosovo, U.N. Security Council Resolution 1244, which provides the mandate for the international mission recognizes it as an interim solution until a final political settlement is achieved. This is the fundamental difference—Bosnia has a political solution defining its status and thereby guaranteeing the independence declared in 1992 that led to war, while Kosovo is still waiting for a settlement to answer its people's own conflict ridden drive toward independence.

In order to understand the dynamics that have led to the conflicts in both regions and the differences in the international solutions applied, Bosnia's and Kosovo's status in both the Kingdom of Yugoslavia (1918-1945), and the socialist federation of Yugoslavia (1945-1991) have to be examined. Because the conflicts that arose from both these states involved more than just Bosnia, Kosovo, and their relation to Serbia, the special role of Croatia as the leading competitor of the Serbs in both Yugoslavias has to be taken into account in order to explain the unique nature of Bosnia's conflict. In the process of reviewing these disparate, and at the same time linked histories, an answer can be given to the question, "How do Kosovo and Bosnia differ?"

Misconceptions of Bosnia

Although Bosnia has been called a case of war along ethnic lines, the three protagonists in that conflict, the Croats, Bosnians, and Serbs do not represent different ethnic groups at all. All three are Slavic peoples with a common origin and language. The one true divisive factor that has led to the idea of separate ethnicities amongst the peoples of Bosnia is religion. The Croats are Roman Catholic, the Bosnians are Muslim, and the Serbs are Christian Orthodox. It is religion, regardless of the level at which it is practiced, that has come to define ethnicity in Bosnia.¹

It was this difference that allowed nationalist politicians in neighboring Serbia and Croatia, Slobodan Milosevic and Franjo Tudjman

respectively, to seek a division of Bosnia along religious/ethnic lines. The territorial ambitions of these two neighboring states, and the large concentration of Croats and Serbs within Bosnia, complicated the conflict and made it a long and bloody affair. According to the 1991 Yugoslav census, no group was in a clear majority. Muslims made up 43.7 percent, Serbs 31.3 percent, and Croats 17.3 percent of the total population.² Contrary to the belief popularized by early books written on the subject of the emerging war, Bosnia was not the site of centuries old hatreds that resulted in countless wars. While great powers including the Ottoman Empire, Austria-Hungary, and the Germans have sponsored warfare there before, the 1992-1995 Bosnian war was the first time that the modern Serbian and Bosnian nation states found themselves in conflict with one another.

Bosnia and Serbia have been part of the same state twice. The first was the Kingdom of Serbs, Croats, and Slovenes (officially renamed the Kingdom of Yugoslavia in 1929) that existed from 1918 to 1940, and the second, possessing the same territory and name as the first was a socialist federation from 1945 to 1991. The violence that served to unravel royal Yugoslavia in 1940, and then socialist Yugoslavia in the 1990's stemmed from the historical rivalry between the Croats and Serbs, and did not originate from Bosnia. Although it was primarily Croats that favored joining with Serbia in order to form the Yugoslav state,³ the Croats did not believe that Serbia's 40 years of independence by 1918 should allow it to play the dominant role in Yugoslavia. Croatia was to become wary of the lead role Serbia played, first in the Kingdom of Yugoslavia, and later with the socialist federation, while most Bosnians came to see their political future tied to the Yugoslav federation and did not share these misgivings to the same degree. Croatia, by virtue of its connections to the Austro-Hungarians, had fancied itself socially and economically superior to its Slavic brethren—the Bosnians and the Serbs. This opinion was not shared by Serbia since, other than Montenegro, none of the small provinces that formed the first Yugoslavia had been states in the modern sense of the word; this left Serbia as the first independent Slavic state in the region to assume the role of a protector or patron.

Increasingly, the Croats viewed Serbia's role as protector as more of a burden than a blessing. This fomented a political conflict that completely fractured Yugoslavia. Bosnia's position in the Kingdom of Yugoslavia and the relationships between its Serbian, Muslim, and

Croatian inhabitants did not represent a truly integrated society, but it was not the cause of Yugoslavia's disintegration. The most disruptive issues in Bosnia stemmed from the Ottoman system under which the Muslim Bosnians were privileged landowners. This fact did incite resentment and violence from their exploited Serbian Orthodox peasants, but centuries of ethnic strife was a misnomer. Material privileges granted under a religious caste system prompted economic strife, but the idea that this was a continuous process unaltered by the Ottoman Empire's collapse, Bosnia's incorporation into Yugoslavia, and the advent of socialism is erroneous. Bosnia had been removed from Turkish influence in 1878 and placed under Austrian administration. As a result of the end of Ottoman rule, Bosnians had come to realize, however reluctantly, that without Turkish governance it had to find a place amongst its Slavic brethren.

Bosnia remained close to Yugoslavia, and by default Serbia, because adhering to the supranational idea of Yugoslavism and cutting deals with the Serbian nationalist parties allowed Bosnia's Muslims to avoid Serbian and Croatian attempts at assimilating them. While WW II put an end to the first Yugoslavia and spurred on episodes of communal violence (unlike Croatia whose active opposition to Serbian domination of Yugoslavia motivated it to support the Axis powers), Bosnia was more or less caught up in the events as opposed to actively ensuring their development. While the Germans may have provided the opportunity to latch on to another patron, their defeat and removal from the Balkan Peninsula necessitated Bosnia's renewed relationship with Serbia and Yugoslavia.

Kosovo in Serbia and Yugoslavia

Like Bosnia, Kosovo had been firmly under the dominion of the Ottoman Empire and a majority of her residents were converted to Islam. While this conferred upon them special rights and privileges, the Albanians of Kosovo retained a separate identity from the Turkish occupiers, which had manifested itself as an Albanian drive for autonomy in the empire on the basis of ethnicity and language.⁴ While the Bosnians were primarily identified as Turkish subjects, they were Slavs in terms of language and origin. The various confessional groups in Bosnia shared a mutually intelligible language that the Turkish authorities allowed them to learn. Albanians on the other hand were forbidden to be educated in Albanian, with a few specific exceptions in the case of

foreign missionary schools. Not being a Slavic language, Albanian is unintelligible to Serbian speakers. The effects of the linguistic and non-Slavic origins that differentiated the Albanians from the Serbs provided for a different experience in the two Yugoslavias than the Bosnians had.

Lands in the Balkans that had primarily Albanian inhabitants were divided into four separate *Vilayets*, or Turkish administrative units. On the verge of the first Balkan war of 1912, the Albanians of Kosovo and other Albanian inhabited provinces in the peninsula mounted a revolt against Ottoman Turkey to ensure their political, linguistic, and administrative autonomy.⁵ Ultimately, their efforts failed as the encroaching armies of the first Balkan Alliance⁶ made the Albanians turn to the Turks to avoid being governed by a Serbia hostile to the Albanian and Muslim character that Kosovo had developed in the 500-year absence of Serbian rule necessitated a change in strategy.

While WWI disrupted the conquests made by the emerging Slavic nations in the Balkan Wars, the victory of the Allied powers over the central powers in WW I confirmed Serbia's earlier gains. While Bosnia had been placed under Austrian administration as early as 1878, and thus realized that without Turkish governance it had to find a place in Yugoslavia with the Serbs, Kosovo's annexation by Serbia and later incorporation into Yugoslavia did not motivate a redirection of the national ambition because opportunities for the Albanians to exist as a distinct nationality did not present themselves.

Although only the Serbs, Croats, and Slovenes were recognized as distinct nationalities in this new state (the Montenegrin kingdom that had existed before WWI had its identity and territory conspicuously swallowed by the Serbs) there were large minorities of Hungarians, Germans, Albanians, Roma, and Macedonians, all of whom with the exception of Macedonia, were neither Orthodox or Slavic in origin, that were not included in the official title of the new state. The Bosnians and the formerly sovereign Montenegrins were also omitted from official terminology, but it was understood by ethnographers at the time that they were to be considered members of one of the three predominant Slavic groups mentioned in the Kingdom's name.

The Kingdom of Yugoslavia was primarily a Slavic construct envisioned as satisfying the needs of the fractured Slavic peoples of the Balkans. Ultimately the notion of Yugoslavism became to be regarded by the

Slovenes, and particularly the Croats, as nothing more than a mask for greater Serbian hegemony. The non-Slavs (Macedonians once again being the exception to this rule) did not join this state of their free will and were not granted equal rights in it. While this was primarily due to the dictatorial nature that the monarchist state adopted, in regards to Kosovo there was a Serbian administration intent on making the living conditions of the Albanian inhabitants untenable.⁷

As was stated, the Bosnians had experienced the loss of Turkish administration and accepted their place in the new Yugoslavia. While the Albanians had more recently been removed from the Turkish sphere of influence, they had already been agitating for a redefinition or complete withdrawal from that system for some decades. The Albanians of Kosovo and western Macedonia looked toward the Albanian state created in 1912 as their future. In both these cases Serbia, which had retained its separate administrative boundaries in Yugoslavia and to which Kosovo was assigned, engaged in a policy of forced assimilation and property confiscations⁸ designed to ensure that the external ambitions of the Albanians would not be fulfilled.

It is important to note that while current Serbian nationalism has been pre-occupied with defining their modern state based on medieval borders, Bosnia was for the most part separate from the Serbian kingdom of the middle ages. Kosovo had, however, been the center of medieval Serbia's kingdom. After its forcible incorporation into modern Serbia and Yugoslavia, Kosovo lost its geographic identity and was officially referred to as Old Serbia. While modern Serbian nationalists used similar arguments in Bosnia's case, their arguments were without merit as Bosnia had existed separately from the medieval Serbian kingdom and pre-WWII Serbian politicians rarely utilized this argument. This is important because in order to ensure that the old Serbia (which had now lost its Serbian majority) remained part of the state. The Albanians had to be removed from Kosovo and be replaced with Serbian colonists.

Ultimately, the Serbian character of the Kingdom of Yugoslavia proved too much for her non-Serbian subjects. While the Albanians in Kosovo were subject to organized campaigns of physical oppression, it was the more subtle conflict between the Serbs and the second largest group in Yugoslavia, the Croats, with their demands for a federated Yugoslavia with a Croatian republic that guaranteed the dissolution of the Kingdom of Yugoslavia on the eve of WW II. Unlike Croatia and Kosovo, where in the former the political class made up the parliamentary opposition,

and in the latter a political class was not developed, Bosnia's major political parties formed coalitions with the Serbian government in order to safeguard their membership's large land holdings, and particularly to avoid the disappearance of Bosnia through partition and assimilation of its Muslims citizens.⁹

World War II

The acrimony between the Serbs and the other peoples in this first Yugoslavia resulted in Croatia becoming an Axis client state and Kosovo being placed in an enlarged Albania with an Italian sponsored puppet government. There was a large communist Partisan movement in Croatia during the war swelled by Serbs defending their communities from fascist Croatian atrocities.¹⁰ A majority of the Croatian population were not supporters of Nazism even though they favored independence over a return to Yugoslavia. For the better part of the war, the Croatian Peasant Party, the largest political organization in Croatia, remained neutral and Croatia's fascist government imprisoned its leaders. Kosovo's Albanians welcomed Axis occupation as liberation from Serbian domination without any of the misgivings many Croatians had, or indeed those harbored by the Albanians of Albania proper, who resented the Italian and German occupiers and began their own indigenous Communist Partisan resistance to them.

Bosnia was far more muddled. While the landowning elite that retained the bulk of political, social, and economic power had been instrumental in retaining Serbian control of the parliament in the early Kingdom of Yugoslavia, the dissolution of the parliament in 1929, and the assumption of full dictatorial powers by the Serbian monarchy removed their influence and brought about the dismemberment of Bosnia they had hoped to avoid.¹¹ During WW II, Bosnia was incorporated into an independent Croatia, albeit separated into two zones of occupation; one German and the other Italian. At the same time that Croatian fascists and Italian and German occupiers could be found in Bosnia, the communist Partisan movement had established its headquarters and began its largest recruiting drive there. Prominent Bosnian leaders could be found in all three camps and the situation was so fluid as to defy a concrete determination as to which camp the Muslims of Bosnia supported.

As history has recorded, it was the Partisans led by the half-Croat, half-Slovene Josip Broz Tito that emerged victorious from the war and

embarked on a reconstruction of Yugoslavia with a socialist framework guaranteeing an end to the old ethnic chauvinisms that ensured her destruction. While the Partisans had to rid the country of its occupiers, their collaborative organized militias and the monarchial loyalists, they were not faced with a uniform national resistance to their program of Yugoslav renewal except in Kosovo. While every other large ethnic group in Yugoslavia had been part of the Partisan movement, the Albanians in Kosovo were militantly opposed to all things Yugoslav in nature, and would not consent willingly to being returned to Serbia as a region.¹²

Even before the war had ended, the Partisans and their Anti-fascist Council for the National Liberation of Yugoslavia (AVNOJ) met in at Jajce, Bosnia in 1943 and decided on the structure of the future Yugoslavia.¹³ Aside from declaring the dissolution of the monarchy, Tito hoped to alleviate the ethnic problems of the first Yugoslavia by transforming the state into a federation with republics representing the different groups. In this way in addition to Serbs, Croats, and Slovenes that had been granted official recognition in the first Yugoslavia as separate peoples, the Jajce conference declared that Montenegro and Macedonia would also be recognized as individual republics. Bosnia at this point was to be an autonomous territory of Serbia, but three months later it was elevated to a republic so as to avoid conflict between Serbs and Croats over it, and to also recognize the individuality of the Muslims.¹⁴ Kosovo was to become an autonomous region, less than the autonomous province of Vojvodina, and remain part of Serbia.

Bosnia was now being granted a greater position than the one it had, but the Albanians of Kosovo were to remain a part of the state they had consistently opposed; Serbia. The post WW II developments in this new socialist Yugoslavia set the stage for the developments that are most pertinent to the modern conflicts in Kosovo and Bosnia. While Bosnia's republican status would put her on a equal footing with the rest of the Yugoslav nations,¹⁵ Kosovo's Albanians were defined as a mere nationality without specific administrative borders or powers. To be sure, these situations were not absolutely clear at the start of the new Yugoslavia, Bosnia's Muslims had to overcome suspicions of their loyalty stemming from their wartime behavior, and the ability to declare oneself a Muslim didn't appear on the census until 1960. The ability to declare oneself as a Muslim was a pivotal part in trying to

resolve the issue of national competition and identity in Bosnia begun with granting Bosnia republican status.

Socialist Yugoslavia 1945-1991

In the initial post war years the Bosnia/Serbia relationship was soured by the events of WW II and a perception on the part of socialist leaders like Yugoslav Vice-President Alexander Rankovic that the Bosnian Muslims were a fifth column.

In this period, Bosnians and Kosovar Albanians were encouraged to declare themselves as Turks in order to facilitate their immigration to Turkey,¹⁶ but this influence was not all encompassing and did not outweigh the positive effects of Bosnia's continued presence, this time as a republic in a federated Yugoslavia. Throughout the 1950s and 1960s Bosnia enjoyed economic subsidies and development, and its Muslim population played a key part in Tito's Cold War non-alignment movement.¹⁷ The population retained the Croatian, Muslim, and Serbian sections in strength, but due to the shared language and culture of these peoples, Bosnia was perhaps the greatest success in the Yugoslav federation. It had the greatest percentage of the population declared as Yugoslavs on the censuses, had the highest rate of intermarriage between its nations, and did not develop any mass movement demanding separation from the federation or a modification of Bosnia's role in Yugoslavia.

In this sense, Bosnia was a mini-Yugoslavia. The brutality of its war and the walls it built around the three ethnic groups was an anomaly constructed from above by nationalist leaders motivated by self-interest rather than a populist movement driven by the mass of common people. Bosnia, and its multi-ethnicity, fell prey to Milosevic and Tudjman who both laid designs on her territory on the basis of the minority populations therein.¹⁸ What maintained Bosnia and drives her still toward retaining that multi-ethnic character is the need, on the basis of having no patron, to maintain an all-inclusive state with the requisite territories to survive as a whole. Kosovo possesses few of these dynamics.

If the supporters of a strong central state with control exerted from Belgrade could treat Bosnia's Muslims commitment to the new state with suspicion, Kosovo's Albanians could be counted clearly in the enemy camp. Eventually Rankovic fell from power and conditions in

both Kosovo and Bosnia improved considerably. Still, the recognition of the Muslims as a nation and the affording of republican status made Bosnia a far different issue than Kosovo. The Albanians of Kosovo, having come to terms with their placement in Yugoslavia, sought out the most favorable conditions for the continued existence in the federation. What this ultimately meant was the pursuit of republic status and full equality with the Serbs rather than subservience to them.

The Kosovar campaign was launched in 1968 with calls for republic status. Tito was receptive to Albanian demands as they were now the complete majority in Kosovo, but was weary of offending Serbian sensibilities over Kosovo and the mythic proportions it occupied in the Serbian psyche (another departure from the Bosnia experience). Moving slowly, Tito from 1968 to 1974 granted the Kosovar Albanians a number of concessions that were formalized in the constitutional amendments to the 1963 constitution.¹⁹ This gave the Kosovars Albanian language education for the first time in the University of Pristina, reversed the prejudicial hiring practices that gave the Serbian minority the overwhelming majority of professional, administrative, and governmental positions (a reverse affirmative action program was taking place in other Yugoslav republics, particularly Croatia which saw their Serbian majority control a disproportionate share of the public sector opportunities without the blatantly discriminatory actions used in Kosovo) and finally dropped the *Metohija* (a distortion of a Greek term that denoted monastic lands) from the title of Kosovo-Metohija.

Decentralization and the 1974 Constitution

This movement culminated with the adoption of the 1974 Yugoslav constitution that granted Kosovo all the rights of the republic without the name. While still called an autonomous province, Kosovo and the other Serbian province of Vojvodina, could issue their own constitutions, assemble a parliament, and hold the same number of delegates to the federal assembly as the other republics. Most importantly, Serbia could not pass legislation affecting the provinces without the provincial assemblies approval. This effectively ended direct Serbian rule. While these reforms were occurring across Yugoslavia, and were at the same time granting greater rights to the republics, Serbia was to become far more upset with their implications for Kosovo than what they meant for Croatia and Bosnia. There are number of reasons for this. First while there were a greater number of

Serbian residents in Bosnia and Croatia than in Kosovo, these places were republics at the start of the new Yugoslavia and effectively beyond Serbian control.

While the efforts aimed at dislodging Serbs from their disproportionate share of power upset those nascent Serbian nationalists that would one day come to power, there was little to do about it in the current federal arrangement. In addition, it was assumed that despite these developments the republics would remain a part of Yugoslavia and thus there would be no fracturing of the Serbian nation. Kosovo, however, had been considered an integral part of the Serbian republic even if demographics and Albanian sentiment did not support that view. Serbia's opposition to Kosovo being taken away from her led to fears that the Albanians would ultimately realize their ambition of leaving Yugoslavia altogether (a fear Tito conceded to when he stopped short of making Kosovo a republic since they had the theoretical right to secede).

Modern Serbian nationalists began their march to power on the basis of Yugoslavia's constitutional changes that decentralized the government and removed Kosovo from Serbia's jurisdiction. While Milosevic and Yugoslavia came to the world's attention because of the horrors of the Bosnian conflict, the naked resurgence of greater Serbian nationalism was borne out of the Kosovo cauldron and spurred the flight of Yugoslavia's northern republics in 1991. Serbian dissatisfaction with the decentralization solidified by 1974 did come to a head until after Tito's death. The death of Tito in 1980 ended the reign of a supranational figure that kept the competing interests of the republics in line. With his death, the continued decay of the Yugoslav economy, the bickering between the Serbs and the Croats, and the continued calls for republican status in Kosovo contributed to a process by which the Yugoslav entities re-evaluated the worth of retaining the federation. For the Croats and Slovenes, historical Croat/Serbian animosities aside, the re-evaluation was primarily economic in nature.

As the richest of the Yugoslav republics, Slovenia and Croatia contributed a larger share of money for economic re-distribution to the smaller and poorer Southern republics. This process was controlled by Belgrade and had led to a heated debate in the mid 1960s as to which was the best method of developing the underdeveloped south. While initially discussed in a socialist context, this debate could not help but take on ethnic overtones as the Slovenes and Croats were essentially protecting their republic's interest over Yugoslavia's.²⁰ Eventually the

north won out as greater economic decentralization meant political decentralization as well. Before the nationalist question erupted in Yugoslavia again, the primary debate was over centralization vs. decentralization with the Croats and Slovenes favoring the latter while the Serbs supported the former.

Slobodan Milosevic of the Serbian League of the Communist party was known as a centralist. The detaching of Vojvodina and Kosovo from Serbia's administrative control struck at both the centralist philosophy of Serbian politicians and at their nationalist claims on the province. After the death of Tito and the ebbing of communist fortunes in the eastern bloc, the question began to lose its socialist trappings and adopted a wholly nationalist character. The first major salvo in the 1980s was the writing of what became to be known as the "Memorandum" by the Serbian Academy of Sciences. In this document, the Serbian authors claimed that genocide had been conducted against the Serbian people. Once again, the familiar territory of Kosovo and the rivalry with the Croats was revisited. While initially condemned by the Socialist authorities in Serbia, the memorandum struck a cord with the Serbian people, particularly with those from Kosovo who were the major topic discussed. Bosnia was mostly a non-issue for the memorandum; the allegations of Serbian exodus from historical Serbian lands, and the replacement of Serbian officials in the republics other than Serbia were mostly concerned with Croatia and Kosovo.

The Serbs, with the largest population in Yugoslavia, highest proportion of senior party posts, army officers, and occupants of the Yugoslav capitol were not only claiming that they were victims in Yugoslavia, but that they were victims of a genocidal campaign.²¹ This position was a complete departure from the perceptions of the non-Serbian citizens of Yugoslavia that had always seen Serbia as the resident bully. Milosevic's rise was predicated on the official sanctioning of the Memorandum (after he toed the Socialist line of condemning it when it first appeared). Milosevic's visit to Kosovo in 1987 began the nationalist march that relied on the mobilization of the Kosovar Serbs to topple the governments of Montenegro, Kosovo, and Vojvodina in order to place them in the hands of his loyalists.

The Unraveling of Yugoslavia

With the northern republics already wary of the benefits of the federation and confident in the strengths of their economies, the revocation of Kosovo's and Vojvodina's autonomy, and the instigation of civil disturbances that toppled the Montenegrin government, Slovenia and Croatia decided to organize referendums on their independence. The last ditch efforts to preserve Yugoslavia by transforming it into a confederacy of independent states failed due to Serbia's commitment to greater centralization vs the republics demands for complete decentralization.²² The summer of 1991 declarations of the Slovenes and Croats for independence inspired the Albanian Kosovars to organize their own referendum on independence and support it with an overwhelming majority. When Bosnia followed suit the following year out of the realization that there was no Yugoslavia left to remain a part of, it followed Slovenia and Croatia as a target of Serbian aggression.

Although Kosovo had raised the greatest nationalist ire, its declaration of independence was not met with a military offensive. The reasons why Kosovo was spared major bloodshed, and the north wasn't, are as follows. As republics, Slovenia, Croatia, and Bosnia had the right to secede granted to them by the 1974 constitution. As such, their declarations of independence entreated the European Council to recognize their sovereignty. The process involved an international legal commission's review of the republic's institutions and state bodies. Kosovo's status differed constitutionally from the republic's, its institutions had already been dismantled, and warfare was substituted with a full Serbian police occupation begun in 1989; the area did not merit the same attention. Serbia was in little danger of losing Kosovo, and had to be careful to avert full scale military operations as it was already dedicated to expanding its territory in the north.

This is how the lynchpin of Serbia's nationalist revival (and the place where conflict was anticipated first), Kosovo, was the last to be embroiled in a Balkan war. This marks another contrast with Bosnia. While that republic was largely an unforeseen casualty of the Yugoslav disintegration, Kosovo had always been known to be a major fault line. This is evident as early as 1989 when then President George Bush warned Serbia that military action in Kosovo would be met with U.S. force. At the time Bosnia was not on the horizon. Bosnia had wanted to remain a part of Yugoslavia because of the benefits and the stability

offered to its potential ethnic flashpoints. Milosevic took it for granted that due to its unique situation and lack of ethnic majority, Bosnia would not move toward secession. Bosnia was caught in the vice of conflicting Serbian and Croatian nationalisms negating the majority of Bosnians' desire to retain the plurality of the republic. There were no extenuating circumstances in the Albanian/Serbian conflict in Kosovo, their mutually exclusive interests were apparent from 1912 and continued unabated through both Yugoslavias. Kosovo, with its lack of Slavic connections and with one of the most homogenous populations in Europe, has consistently been opposed to its incorporation into Yugoslavia. The differing natures of Bosnia and Kosovo, both in terms of ethnic character, Yugoslav experience, and former constitutional status, must be acknowledged for the international community and its peacekeeping missions to successfully implement their mandates.

The Limits of Multi-Ethnicity

Bosnia's statehood was recognized in 1993, but it took the 1995 Dayton Accords and a 60,000 strong peacekeeping force to define the nature of that state and preserve it. As a result of the unique nature of Bosnia's ethnic dispersal and the genocidal practices of the war which wiped clean huge swaths of land of their ethnically mixed populations, the Dayton Accords sought to retain as a whole, an independent state that could otherwise be divided into halves, or even thirds by its competing populations and neighbors. In order to ensure that this did not occur, the international mission in Bosnia, its peacekeeping contingent, and the Bosnian Muslims, who would be the odd man out in a partition, were committed to the restoration of a multi-ethnic society.

Bosnia's multi-ethnic society is in political terms a power sharing arrangement essential for stability in a state where three peoples claim separate national identities yet none comprise 50 percent of the total population. Dayton, therefore, was a political solution, however flawed and dependent on international supervision, which attempted to satisfy the demands of all three of Bosnia's sizable ethnic groups while at the same time ensuring their participation and cooperation in a single state. Whereas in Bosnia there are at least sections of the population that support a multi-ethnic program in order to preserve peace and territorial integrity, in Kosovo multi-ethnicity is entirely internationally sponsored and consequently artificial. Multi-ethnicity is perceived by the Kosovar Albanians as an excuse to ignore their dream of independence and

force them to remain part of Yugoslavia for the sake of a small Serbian minority. For the Kosovar Serbs, multi-ethnicity falls far short of returning control of Kosovo to them and means that they should accept full political and human rights for all citizens including the Albanian majority. Such democratization has implied majority rule, a condition the Serbs have and continue to find unbearable in Kosovo. Despite these realities the United Nations Mission in Kosovo, and the Kosovo Force Peacekeepers are committed to a multi-ethnic society in a place where the demographic, linguistic, religious, cultural, and political conditions make the pursuit of this goal a misguided effort.

Ultimately the defining differences between Bosnia and Kosovo are the political statuses assigned to each and the nature and size of the various peoples that inhabit them. Kosovo is not an internationally recognized independent state, and unlike Bosnia and its Dayton Accords, no final political solution has been applied. In Bosnia, the international community waits for its solution to work while in Kosovo, the mission will continue until a political solution that works is found. This is, of course, an oversimplification, but should serve to demonstrate the ease with which the myriad complexities already discussed can be disregarded, or overlooked. Kosovo is a separate mission from Bosnia requiring a departure from the methods and political assumptions applied there.

¹Bogdan Denitch, *Ethnic Nationalism: The Tragic Death of Yugoslavia* (Minneapolis: University of Minnesota Press, 1996) 29.

²Noel Malcolm, *Bosnia: A Short History* (New York: NYU Press, 1996) 223.

³Ivo Banac, *The National Question in Yugoslavia*, (New York: Cornell University Press, 1984) 89.

⁴Stavro Skendi, *The Albanian National Awakening, 1878-1912* (Princeton: Princeton University Press, 1967) 102.

⁵Stavro Skendi, *The Albanian National Awakening, 1878-1912* (Princeton: Princeton University Press, 1967) 428.

⁶Serbia, Greece, Montenegro, and Bulgaria formed the first Balkan Alliance in 1912 to conquer the Ottoman Empire's remaining European territory and drive the Turks from the continent.

⁷Noel Malcolm, *Kosovo: A Short History* (New York: New York University Press, 1998) 283.

⁸Ivo Banac, *The National Question in Yugoslavia*, (New York: Cornell University Press, 1984) 299.

⁹Ivo Banac, *The National Question in Yugoslavia*, (New York: Cornell University Press, 1984) 375.

¹⁰Bogdan Denitch, *Ethnic Nationalism: The Tragic Death of Yugoslavia* (Minneapolis: University of Minnesota Press, 1996) 62.

¹¹Ivo Banac, *The National Question in Yugoslavia*, (New York: Cornell University Press, 1984) 376.

¹²Noel Malcolm, *Kosovo: A Short History* (New York: New York University Press, 1998) 317.

¹³Milovan Djilas, *Wartime* (New York: Harcourt Brace Jovanovich, 1977) 315.

¹⁴Milovan Djilas, *Wartime* (New York: Harcourt Brace Jovanovich, 1977) 356.

¹⁵The Yugoslav Constitution defined its six republics (Bosnia, Serbia, Montenegro, Croatia, Slovenia, and Macedonia) as nations and granted them an elevated status compared to the minority populations of Roma, Hungarian, Albanians, etc. who were defined as nationalities. The vague criteria used to define a nation was challenged by the Albanians of Yugoslavia, who by the 1980s, outnumbered the Slovenes, Montenegrins, and Macedonians.

¹⁶Noel Malcolm, *Kosovo: A Short History* (New York: New York University Press, 1998) 322.

¹⁷Noel Malcolm, *Bosnia: A Short History* (New York: NYU Press, 1996) 197.

¹⁸Tim Judah, *The Serbs* (London: Yale University Press, 1997) 174.

¹⁹Dennison Rusinow, *The Yugoslav Experiment, 1948-1974* (Berkeley: University of California Press, 1977) 228.

²⁰Dennison Rusinow, *The Yugoslav Experiment, 1948-1974* (Berkeley: University of California Press, 1977) 134.

²¹Branka Magas, *The Destruction of Yugoslavia* (New York: Verso Press, 1993) 199.

²²Sabrina Petra Ramet, *Balkan Babel* (Boulder, Colorado: Westview Press, 1996) 48.

CHAPTER IV

Kosovo's Political Evolution

Jusuf Fuduli

The arrival of the international mission in Kosovo has obviously had profound effects on Kosovo, but perhaps the most dramatic have been in the political arena. This is to be expected in a province where the previous political status quo of a Serbian-dominated dictatorship has been overturned in favor of developing democratic and self-governing institutions open to the formerly disenfranchised Albanian majority. Kosovo's political evolution since June 1999 has involved more than just a reversal of roles for the Serbs and the Albanians, but has included the first introduction of modern political pluralism Kosovo has ever seen.

As the implementation of the international mandate removed a decade of Yugoslav President Slobodan Milosevic's despotic administration in Kosovo it also ensured that 10 years of Albanian political monopoly under Ibrahim Rugova's party, the Democratic League of Kosovo (LDK)¹ was also swept aside. At the start of the international mission Rugova, who had been unofficially elected and unrecognized as the president of a Kosovar republic, was declared politically dead by most observers. Conversely, Milosevic, while suffering not only a drastic military, but territorial loss in an area that he and his nationalist supporters had imbued with mythic importance retained his powers. Today their positions have been drastically reversed in a turn of unexpected yet positive turn of events.

UNMIK

The key to understanding Kosovo's new political dynamics must begin with a discussion of the United Nations Mission in Kosovo (UNMIK) and its administrative powers. Under U.N. Security Council Resolution 1244, UNMIK was authorized to establish a transitional administration in Kosovo that would lead to self-governing institutions. The task has

been monumental. The exit of Serbian forces from Kosovo was accompanied by nearly one-half of the Serbian residents as well as the majority of former administrators and civil servants. While the Albanians were not sorry to see them go, having been removed from most administrative posts over 10 years earlier, they did not have the necessary personnel to help UNMIK fill the gap. The only organization that resembled something of a government during the Milosevic regime was the LDK.

The LDK was one of the first political parties to form in Kosovo in response to Slobodan Milosevic's efforts to disenfranchise the Albanian majority at the start of the last decade. From the start of 1990, until the height of the Kosova Liberation Army's (KLA) insurgency in 1998, the LDK almost exclusively represented the interests of Kosovo in the domestic and international political scene. It adopted a non-violent/non-confrontational policy towards Serbian domination that was punctuated by the formation of a parallel government, which refused to recognize the Serbian state and held a popular referendum on the independence of Kosovo in 1992. This *independent Kosova* provided the local population with rudimentary health care, education, self-administration, and political representation when the Serbian government refused to.

In short, a vast organization and funding apparatus, supplied with money by a 3 percent tax levied on the Kosovar diaspora, operated without local political opposition for almost a decade. However, the LDK's armor had cracked when the Kosovo Liberation Army (KLA) refuted a pacifistic approach to achieving Kosovo's independence and began an insurrection that led to war. The war drove most of the LDK leadership out of Kosovo and effectively dismantled the parallel state apparatus. The only Kosovar Albanian organization that remained during the Serbian offensive and was in place to assume control of the capitol of Pristina, and nearly every other city in Kosovo, was the KLA. That organization had already established a political directorate under the leadership of Hashim Thaci, which later reorganized itself as the Democratic Party of Kosovo (PDK)² when hostilities ended. Having never left the province, and provided with support from the KLA, the PDK presented itself to the newly arrived, and often uninformed UNMIK, as the only political organization of worth. In nearly all of Kosovo's municipalities, councils comprised of PDK members pushed for UNMIK recognition. As a result, the LDK, which had been the sole

political power in Kosovo, was virtually excluded from the initial administration of the province.

This local activism of the PDK was part of the greater agenda of the Provisional Government of Kosovo (PGOK). The Balkans Contact Group (United States, France, Germany, Italy, Russia, and Great Britain) had organized the Rambouillet peace talks, named after the castle where they took place in France, from February 6-18, 1999. The purpose of the accords was to bring an end to the fighting in Kosovo between the KLA and Serbian forces, guarantee a return of the estimated 300,000 displaced civilians, establish an international armed force in Kosovo to monitor the withdrawal of Serbian troops, and establish an interim constitution and government until elections could be held. While the Rambouillet Accords never became a working agreement in Kosovo, they did have a legacy for the local political parties, and the U.N. administration in Kosovo. UNSCR 1244 states that one of the main responsibilities of the international mission in Kosovo will involve, "Facilitating a political process designed to determine Kosovo's future status, taking into account the Rambouillet accords." Since 1244 makes frequent reference to Rambouillet it should be of no surprise that the Albanian political leaders of Kosovo decided to pursue some of its tenets at the start of the UNMIK administration.

PGOK

The interim government mentioned in the Rambouillet Accords that was to govern Kosovo until elections could take place was established by the Albanian delegates as the Provisional Government of Kosovo (PGOK). KLA political director and future leader of the PDK political party, Hashim Thaçi was named Prime Minister of the PGOK while the LDK and a coalition of the smaller Kosovar Albanian parties called the United Democratic Movement (LBD) were to contribute members for other ministerial posts. The PGOK was at first hampered by the Serbian government's refutation of the Rambouillet agreement, and then by the LDK's later refusal to participate. Despite this, the PGOK was formed minus the LDK's leadership (some party members did participate without authorization though), and moved to assert itself as the government of Kosovo, with Thaçi as the province's prime minister before UNMIK could establish itself. As a result, the PGOK presented a number of problems for UNMIK's initial attempts to administer Kosovo. Some of these have included the following:

- Reluctance to recognize UNMIK's precedence of authority, and asserting that Thaçi was at least equal in authority to UNMIK head and Special Representative to the U.N. Secretary General, Bernard Kouchner.
- Establishing a Ministry of Public Order with a law enforcement body, the MRP, to police Kosovo in direct contravention of the U.N.'s mandate to establish a police force.
- Attempting to transform all Serbian State owned property into *Republic of Kosova* state property. This included lucrative enterprises such as gas stations whose profits have been used to benefit individual members of the PGOK.
- Posting proclamations forbidding private purchase of this newly created state property (this has often meant all Serbian owned property).
- Taxation of local business in order to finance itself.

UNMIK and KFOR refused to legitimize the PGOK and instead it became an unrecognized parallel government like the LDK's had been during the 1990s with the following important exceptions. When the LDK operated a government they were the only ones to do so since the Serbian administration was not interested in being all-inclusive. UNMIK, however, was mandated to incorporate the local population and had a budget to do so. Knowing that they could not compete with UNMIK's administration, the LDK didn't continue the practice of parallel institutions. In the face of this reality, as well as continued opposition from KFOR, UNMIK, and the now returning LDK leadership the PGOK was doomed to failure.

JIAS

Eventually, UNMIK revamped its attempts at administration with the Joint Interim Administrative Structure (JIAS) agreement implemented on January 31, 2000. The JIAS devised three political structures responsible for incorporating Kosovo's citizens in the administration of their province and ensuring that the international mission could continue with the formation of eventual self-governing institutions. The first of these bodies was an executive board called the Interim Administrative Council (IAC) that acted as the highest decisionmaking

body in Kosovo. SRSJ Kouchner was the chief executive while eight members, four local and four UNMIK international officials made up the council. The four local seats were occupied by Ibrahim Rugova, President of the LDK; Hashim Thaçi, President of the PDK; Rexhep Qosja,³ President of the LBD; and Bishop Artemije⁴ leader of the Serbian National Council (SNC).

There were also established 20 administrative departments ranging from justice to education that were co-run by UNMIK officials and local representatives. Twelve of the departments were split equally amongst the three Albanian political parties represented in the IAC while the rest were allocated to independents and minorities. In order to appease the smaller political parties that felt excluded from the IAC and the administrative department appointments, the already existing Kosovo Transitional Council (KTC) was expanded as a consultative forum.

Much of the JIAS's programs were slow to be realized and while on paper each internationally held position was matched by an appointed local representative with ostensibly equal powers, this was not to be mistaken for meaningful self-government at the provincial level. At the municipal level there was greater success in developing self-government, but it wasn't uniformly applied in all of Kosovo's 30 municipalities.

Municipal Government

An UNMIK Municipal Administrator (MA) administered each of Kosovo's municipalities and was responsible for incorporating local participants in the administration. Prior to the JIAS agreement this task was fulfilled with municipal councils. These bodies were strictly consultative in nature and had no executive, or decisionmaking powers. No set regulations defined the powers of the councils or the responsibilities of their members and for all practical purposes they merely served as a means of information exchange. The criteria for membership varied and were not limited to political figures or former KLA commanders, but the reality in the immediate aftermath of hostilities was that KLA-turned-PDK members were the de facto power brokers at the local and provincial level and they imposed themselves on the fledgling local administration. Most of these individuals had no formal experience or education in the political or administrative field and were simply in the process of consolidating power for their party.

The issue was further complicated by the protests of the formerly entrenched LDK, which had broader experience in the administrative arena, albeit unofficial and demanded that due to their former electoral victories they receive a majority of council seats. In many municipalities there developed a system where the MA simply governed by decree due to the political deadlock in the councils.

Local administration in Kosovo was also restructured with the implementation of the JIAS agreement. In addition to the consultative municipal councils, administrative boards were formed to provide local administration with administrative departments mirroring the 20 created at the provincial level. The number of these departments varied from one municipality to another, but they represented a salaried position to a local appointee that was now responsible for a given public service. This was the first structured attempt at self-administration, but it was imperfect. In many cases the people selected for the administrative posts were wholly unqualified and the political rivalries only intensified with the opening up of more positions. The PDK insisted that their party, which had never stood in an election, had majority support while the LDK, which had never stood in a free, multiparty election, claimed political supremacy. The rivalry between the two parties dominated political life in Kosovo at both the provincial and municipal level. Unfortunately, the political differences between the two parties were not confined to rhetoric and there was a series of attacks, including murder of LDK political activists.

The violence was mostly confined to the area of the Drenica Valley where the KLA had first formed and the PDK had broad support. Consequently the PDK were publicly suspected of the attacks, but no evidence has surfaced to prove it. In this environment the first multi-party elections ever to be held in Kosovo were conducted.

Municipal Elections

The municipal elections on October 28, 2000, were the first held under the UNMIK administration and can be characterized as the first democratic multiparty elections ever organized in Kosovo. The conducting of elections fell to the Organization for Security and Cooperation in Europe (OSCE), which is entrusted with the task of democratization and institution building in Kosovo. The voters were to elect representatives to the new municipal assemblies as the formerly

consultative municipal councils were now giving way to a larger and more decisive body with defined powers and responsibilities. The elections were less than the parliamentary elections most Kosovar Albanians had wanted, but served the purpose of building government from the bottom up.

The overriding consideration involved with the conducting of elections was violence on the day of the vote and a wave of violence and intimidation once the new assemblies were formed. Voter polling had demonstrated that the PDK was far behind the LDK in support and the fear was that they would not accept a loss peacefully. The electoral results proved the polls right as the LDK decisively beat the PDK by an average of 30 points granting them simple and absolute majorities in 21 municipalities. The anticipated violence on election day never materialized as most Kosovar Albanians treated the elections as a test not only of their democratic potential, but also their claims to self-determination. The municipal assemblies are still in their embryonic stage of receiving training, developing bylaws, and hiring civil servants so it is still too early to gauge the willingness of the PDK to accept the role of an opposition party. This will be a difficult transformation given the venom of the PDK's political campaign against the LDK, which went so far as to suggest that their leaders were Serbian collaborators and traitors.

The ability to accept the opposition role will be further muddled by the part socialism has played in the political education of Kosovo's people. As insistent as the Albanian population is in their denunciation of socialism since its inception in Kosovo, the fact remains that socialism represents the Kosovars' first exposure to modern organized politics. This has left even the most dedicated democrat with a legacy of knowing only one party, one state. Even though Kosovo is en route to develop a parliamentary system the majority of her would-be participants will treat future elections as an all-or-nothing prospect, failing to understand the legitimate place an organized opposition holds in a democracy.

Kosovo's Serbs

Up till now the discussion of Kosovo's political evolution has involved the Kosovar Albanians and the international community. The Serbs have not been included because they have very much remained outside the process. At both the provincial and municipal level, Serbian political

leaders have consistently boycotted both UNMIK appointed positions and the later electoral process. Understanding Serbian political development in Kosovo is actually far more complex than the Albanians'. Although there are now nearly 20 Albanian parties officially registered in Kosovo ranging from the Greens to the Social Democrats none are in disagreement over the demand for an independent Kosovo or the necessity of working with the international community as a means of developing the necessary state institutions. The Albanian parties are quibbling over which of them should exercise power, not over the structures through which power should flow.

The KosovarSerbian parties are united in their opposition to the Albanian demand for statehood and generally regard KFOR and UNMIK as part of an occupation. Other than these positions, there has been little solidarity and more importantly no program to achieve a future goal. The reasons for this are twofold. The Albanians were disappointed that the arrival of the international mission wasn't to be the commencement of their independence, but the mission's mandate provided them with space to pursue their broader goals within a transitional arrangement. UNSCR 1244's references to the establishment of self-governing institutions have catered to the formerly disenfranchised Albanian majority's desire for self-government. UNSCR 1244 states that an interim administration through which "the people of Kosovo can enjoy substantial autonomy within the Federal Republic of Yugoslavia" will be established. While the self-governing institutions are being constructed, every aspect of the former Yugoslav state presence from currency to stamps in Kosovo have been removed to a degree that Kosovo remains part of Yugoslavia only on paper.

The outcome has meant that Kosovar Albanians have been provided the opportunity to govern themselves free from Serbian interference, but with international supervision. The Kosovar Serbs nominally have the same chance to share in that self-government, but they are not free to exercise their rights fully and at the same time have no desire to. When, prior to Milosevic, Kosovo was self-governing its Serbian citizens could not bear being relegated to a small minority with no more influence than their numerical preponderance allowed. The Kosovar Serbs opted to do away with Kosovo's self-government and their seats in its assembly to become an even smaller constituency in the Serbian parliament if it meant that they no longer had to be governed by Albanians bent on independence from Serbia. Since the ill will the

Kosovar Albanians bear the Serbs prohibits them from traveling freely they are not to be expected to participate fully in a new administration.

Freedom of movement, continued violence against the members of their community, and demands for the full return of refugees before they participate in the international administration have been key demands of the Kosovar Serbs. Although these are valid concerns they are primarily considerations of those Serbs residing south of the Ibar river and the divided city of Mitrovica. The Kosovar Serbs living north of this boundary have unhindered access to Serbia and neighboring Serbian population centers as well as the security of homogenous municipalities devoid of sizable Kosovar Albanian populations. These very different circumstances have not altered their views on building self-governing institutions and the majority Serbian inhabited municipalities of Zvecan, Leposavic, and Zubin Potok did not register an electorate for the municipal elections. Consequently elections were never held in the north and UNMIK exercises negligible administrative control there.

The disparate conditions that exist geographically fostered a political split in the Serbian National Council (SNV). Although it had been one organization it became divided over the decision to participate in the new JIAS structure. The northern branch under the leadership of Oliver Ivanovic urged Bishop Artemije of the Serbian Orthodox Church and leader of the SNV to continue boycotting the U.N. administration. As discussed, the north is relatively secure in their Albanian-free municipalities and free access to Serbia, but the Serbs living to the south represent islands in a sea of Albanians that cut them off from the rest of the world. The only lifeline available to Bishop Artemije's flock was through UNMIK and KFOR sponsored protective escorts delivering them food, medicine, and convoys to Serbia. The north was effectively asking the south to ignore their benefactors. Bishop Artemije compromised with the refusal to participate actively in the JIAS, but to retain observer status. Ivanovic and his followers split regardless. Later, and involving the same issues, Bishop Artemije's partner in forming the SNV, Momcilo Trajkovic removed his Serbian Resistance Movement as well. These splits provided no material or political benefit since none of the now departed members of the SNV had anything substantial to offer their people in lieu of UNMIK support. Both Trajkovic and Ivanovic retained Artemije's opposition to Milosevic, and the only

other benefactor the Serbs in Kosovo had was Milosevic's Socialist Party of Serbia (SPS).

UNMIK and KFOR courted SNV support because they opposed Milosevic, but he and his SPS did not depart Kosovo altogether. They retained an unsanctioned administrative structure parallel to the United Nations in most Serbian enclaves known as the Serbian National Assembly that continued to distribute pensions, salaries to government employees, and ensured that the Kosovar Serbs boycotted UNMIK institutions. Although Milosevic was becoming reviled in Serbia proper, Kosovo's Serbs were relying on his propaganda promises to return the Serbian army to Kosovo to drive out KFOR and the Albanians forever to come true. Despite the exhortations of the divided SNV branches and other opposition leaders to vote for Vojislav Kostunica against Milosevic in Yugoslav presidential elections on September 24, 2000, the majority of Kosovar Serbs voted for Milosevic. While these results could be attributed to the open bribery and continued presence of SPS strong arm tactics, the parliamentary elections held 2 months after the dismantling of Milosevic's government revealed that 50 percent of Kosovo's Serbs voted for him.

The Future

The Kosovar Albanians have much to be pleased with having been removed from a yoke they chaffed under for most of the past century. They also proved naysayers wrong with the conduct of the municipal elections and continue to organize politically for what they expect to be parliamentary elections in the summer of 2001. Although the incoming UNMIK chief Hans Haekkerup has stated that general elections should happen as soon as possible. The U.N. mission's mandate is dedicated to creating institutions to one day turn over to Kosovo's population so that they may govern themselves.

Democracy has been called the tyranny of the majority—in Kosovo that group would be the Albanians. Kosovo's Serbs had once represented a tyranny of the minority so there should be no surprise that they have nothing to look forward to in the immediate future. Even though Kosovo is in a transitory stage with no guarantees on the outcome, the Albanians have space with which to grow as a people still seeking self-determination and democracy. For Kosovar Serbs this only provides them with more time to contract. While Serbia undergoes a democratic revival and a

repudiation of some of Milosevic's policies, Kosovar Serbs have little reason to celebrate. The new government hasn't forgotten them, but has recognized the reality of the international mission in Kosovo and is willing to cooperate with it. This was something Milosevic would never have deigned to do. The Kosovar Albanians have worried over Kostunica's election in fear that the departure of Milosevic means the removal of one of their most potent arguments for independence. The reasoning of this argument is dependent on the premise that all things wrong with Yugoslavia started and ended with Milosevic.

The failure of the first Yugoslavia is a historic rebuttal to such an argument as is Montenegro's continued demands for a restructuring of Yugoslavia as equal halves and not just a whole dominated by Serbia. Whatever the logic of this belief is the fact remains that Kostunica must now concentrate on reviving Serbia. Milosevic forsook that republic as well as all of Yugoslavia for the nationalist myth of Kosovo, it is unlikely that Serbia is willing to make that sacrifice again. In any case, the status quo remains constant and with it comes satisfaction to Kosovo's Albanians and disgruntlement to Kosovo's Serbs. In a place where two peoples possess such mutually exclusive goals, nothing less could be expected.

¹All abbreviations of Serbian and Albanian political parties appear as they do in their native languages.

²They were initially known as the Party for Democratic Progress in Kosovo (PPDK).

³Qosja resigned his position after his political coalition, which had been disintegrating for months, received less than 2 percent of the vote in the October 28, 2000, municipal elections.

⁴Bishop Artemije never took his seat on the IAC.

CHAPTER V

The Kosovo Elections

Rich DuBreuil and Joseph Nowick

It is important to understand the historical context in which the municipal elections took place. Following the end of the Serbian aggression in Kosovo, the Serbian military and paramilitary forces departed. This was followed by the arrival of NATO's Kosovo Force (KFOR) troops and the civilian components of the international community, in this case the United Nations Mission in Kosovo (UNMIK) and the Organization for Security and Cooperation in Europe (OSCE). These agencies began to focus on the electoral process as a means for establishing democratization in Kosovo. For many months there were conflicting views as to when elections should be held. Those who did not want quick elections argued that there were significant security problems. Also, the Kosovo Liberation Army (KLA) would have to be transformed from a military to a civilian force. Finally, it would be necessary to update voter registration lists that had been compromised during the war.

The Kosovar Albanians had some experience in managing a partially democratic process under adverse conditions. After Slobodan Milosevic replaced Kosovo's autonomous status with a Serbian-run police state in 1989, ethnic Albanians elected Dr. Ibrahim Rugova as their president and chose a parliament. While the international community did not recognize these elections as valid, they nonetheless reflected a commitment of Kosovar Albanians to the goal of democratization in Kosovo.

Before any election could take place, it was important to establish key OSCE electoral conditions for free and fair balloting. These conditions included but were not limited to the following goals:

1. Freedom of movement for all citizens;
2. An open and free political environment;
3. An environment conducive to the return of displaced persons;

4. A safe and secure environment that ensures freedom of assembly, association, and expression;
5. An electoral legal framework of rules and regulations complying with OSCE commitments; and
6. Free media, effectively accessible to registered political parties and candidates, and available to voters throughout Kosovo.

UNMIK, with the agreement of OSCE, decided that these conditions were met (at least to a minimal degree) in order to conduct voter registration in the summer of 2000 and an election in the following fall. The municipal elections would be held first, followed by any possible parliamentary elections at a later date.

The 2000 Kosovo Municipal Elections

During the summer of 2000, Dr. Bernard Kouchner, the Senior Representative to the Secretary General (SRSG), decided that municipal elections would be held in Kosovo on October 28th for the purpose of establishing a local government administrative structure. This structure consisted of elected officials in each municipality who would have the authority and responsibility of directing and running the support and civil agencies in their area. There were 30 municipalities and over 1 million registered voters Kosovo-wide. In the Gnjilane region, there were approximately 190,000 registered voters.

The predominant political parties were the PDK (Thaci), LDK (Rugova), and AAK (Haradinaj). Mostly those who fought for Kosovo during the conflict supported the PDK. Mostly older citizens and non-radical elements that supported a more peaceful transition for Kosovo supported the LDK. The AAK was a more radical group who envisioned a greater Kosovo and a more forceful approach to gaining independence from Yugoslavia. Each of the five multinational brigades had their own makeup of political party densities. In Multi-National Brigade (MNB) East, the LDK was particularly strong in five of the seven municipalities.

During the registration and election process, party-on-party violence and party infighting were unpredictable. There were incidents of threats, bomb hoaxes, and even murders. Candidates who felt that their life was in danger were issued a WAC (weapons authorization card) or provided

security by the UNMIK-P. Most of the reports of violence were from PDK supporters towards LDK candidates and their supporters.

The OSCE was the primary in the elections. Within the OSCE, the Director for Election Operations, Jeff Fischer, led the planning and execution of the municipal elections. This organization took over after the registration process was handed off from the U.N. The OSCE had its main headquarters in Pristina and a regional headquarters in each of the different regions. Each region had assigned field offices depending on the amount of municipalities located within the region. Each field office was assigned an election officer who coordinated the election activities for that municipality.

The elections were of particular importance to the people of Kosovo (mostly the Albanian majority) because it meant one more step towards the determination of their future (independence). The Serbian minority chose not to participate in the registration process and was not granted the choice of voting on 28 October. Due to the rise of Kostunica and the demise of Milosevic, the Serbian population is expressing a willingness to have elections for representation in the municipalities (rather than having appointees).

Primary Organizations Supporting The Elections

The United Nations Mission in Kosovo

The basic authority for the NATO deployment into Kosovo rests on Resolution 1244 (1999) of 10 June 1999, whereby the United Nations Security Council, acting under Chapter VII of the Charter of the United Nations, authorized the Secretary General, with assistance of relevant international organizations, to establish an international civil presence in Kosovo, known as the United Nations Interim Administration Mission in Kosovo (UNMIK). The mission was to provide an interim administration in Kosovo with the mandate as described in the resolution. It made clear that all legislative and executive authority with respect to Kosovo, including the administration of the judiciary, is vested in UNMIK and is exercised by the Special Representative of the Secretary General.

Of particular importance to the municipal elections is the authority of the Special Representative of the Secretary General to issue legislative

acts in the form of regulations. These regulations controlled many important aspects of the municipal elections, including the conduct of political parties and candidates. Per Regulation No. 2000/021, a Central Election Commission (CEC) was established to be responsible for the conduct of elections in Kosovo. The CEC had the authority to issue regulations and electoral rules that controlled the conduct of the elections. One of the most important of these regulations was 2000/21, which was a code of conduct for political parties' coalitions, candidates, and their supporters. The electoral rules also governed the election and included the following:

- a. Definition and design of sensitive electoral material, including the design of the ballot paper
- b. Accreditation of domestic and international observers
- c. Political party, coalition, and candidate registration
- d. Establishing competent authorities responsible for the conduct of elections, such as the Municipal Election Commissions and polling station committees
- e. Voter registration provisions
- f. Polling and counting procedures
- g. Voter information
- h. An electoral code of conduct

The CEC also created the Election Complaints and Appeals sub-Commission (ECAC) to be an electoral complaints body to ensure that the appropriate actions or sanctions were taken to address any violation of electoral rules and of any other regulations or rules governing the elections. During the course of the election, the ECAC received many complaints on a variety of alleged violations of electoral rules, especially those found in the code of conduct. While the ECAC had the authority to remove candidates for these violations, it was not applied. However, political parties were fined several thousand DEM. The most common complaint involved the misuse of campaign materials or the failure of a political party to timely notify the appropriate authorities about an upcoming political rally.

Organization for the Security and Cooperation in Europe (OSCE)

The OSCE was the primary organization running with the ball during the election planning process and execution. The organization had been running fairly strong after conducting several successful elections in Bosnia and Albania. With just under 1,000 polling sites Kosovo wide, the OSCE brought in 1,400 international supervisors to support the elections.

The supervisors participated in a 4-day training session at Lake Ohrid, in the Former Yugoslav Republic of Macedonia, where they were trained by the OSCE, KFOR, and UNMIK-P. KFOR's role in the training covered map reading, communications, first aid, mine awareness, and emergency preparedness training.

The supervisors deployed into Kosovo over the course of 2 days in convoys of four buses. Each day there were four convoys. Each of the convoys were pre-manifested and coordinated with the FYROM customs and police for efficient processing through the border. The convoys then linked up at the 507th Greek Battalion Headquarters where they met their UNMIK-P and OSCE field office escorts.

Upon arrival at the field offices, both the OSCE Regional Security Officer (RSO) and KFOR gave the supervisors a security briefing. The RSO was the key person responsible for the security of OSCE personnel and activities. About 60 days prior to the election, an election security officer was assigned to assist the RSO. TFF provided accommodations at Camp Montieth for roughly 59 of the international supervisors. They were charged 25 DM per night and had easy access to the Regional Headquarters in Gnjilane.

United Nations Mission in Kosovo Police Force (UNMIK-P)

The United Nations Police force was composed of over a 1,000 officers covering five different regions. Each region was challenged in its operations, activities, and manpower. In MNB East, the police force was given primacy in its operations in conducting law enforcement activities. The police, in order to maximize its effectiveness during the elections, implemented a no-leave policy.

MNB East had just over 250 police officers operating during the elections. Each polling center was assigned a minimum of two police

officers (International and/or Kosovo Police Service). The larger centers were assigned anywhere from 4 to 10 officers. The experience level and nationality varied from station to station. In the MNB East sector, UNMIK-P Station representatives were from the United States, UK (Scotland), India, and Pakistan. We did encounter language difficulties with some of the station personnel, but for the most part, liaison was good. Most of the officers were active police officers in their home countries although some were retired.

The overall experience level varied from officers with no experience in peace support operations to those who had handled extreme situations such as in Northern Ireland. The lead planner for UNMIK-P during the elections was an officer from India. He had little or no field experience, but was knowledgeable in some areas of election organization.

Kosovo Police Service (KPS)

The Kosovo Police Service is a locally trained police force that has been empowered by the U.N. and UNMIK-P. Their presence has increased all over Kosovo and has added a much needed reinforcement for the International Police Officers. Most of the officers are employed in the area in which they live. Their experience level also varies. Officers are both men and women who are readily identifiable by their uniforms. During the elections the KPS served an important reinforcing role for the international officers, especially in crowd control and explaining to the public what was happening.

The Council of Europe (COE)

The Council of Europe is an organization that was sent to observe the electoral process in Kosovo. In the Gnjilane Region approximately 37 observers deployed in to the sector. The observers rotated between centers, and evaluated how the voting process was being conducted and how the ballots were being counted and transported. TFF housed 14 observers on Camp Bondsteel due to the extreme shortage of available rooms at local hotels. Each was charged roughly 25 DM per night. The observers traveled with a hired interpreter and driver who knew the local area. Their vehicles were marked with a very identifiable sticker placed on the windshield of the car.

The Kosovo Election Process

The election process in Kosovo was conducted similarly to that during the Bosnia elections with one exception. For the first time voters were able to choose the candidate they wanted to hold a municipal seat. Each of the parties could nominate candidates up to the amount of seats available in each municipality, providing they met the rules and qualifications established by the OSCE Department of Elections. The results of the election showed a slight dominance of LDK over the PDK in the Gnjilane Region. The LDK was particularly strong in Urosevac (67.9 percent of the vote), Gnjilane (62.6 percent of the vote), Kamenica (59.8 percent of the vote), and Vitina (59.7 percent of the vote). The PDK won the Kacanik Municipality (52.4 percent of the vote), Novo Brdo (49.9 percent of the vote), and Strpce (53.7 percent of the vote), but the actual seats the PDK occupies are much less than that of the LDK due to the population density difference between the municipalities. The LDK occupies 121 seats compared to the 73 seats of the PDK.

Types of Polling Stations

The MNBE sector had polling centers instead of polling stations. These centers ranged in size from the mega centers with 6,000 or more registered voters, to smaller centers with anywhere from 1,200 to 4,000 voters. MNBE had 10 mega centers: 2 in Gnjilane, 3 in Urosevac, 1 in Vitina, 3 in Kamenica, and 1 in Kacanik.

These centers would have anywhere from 8 to 18 international polling supervisors and additional local national election staff assisting in the voting process. Combined with UNMIK-P, the total staff at one of these centers was over 40. Inside the centers the supervisors would cover down on individual polling stations. There was one manager of the polling center who was responsible for the overall organization and administration of the center and for maintaining communication with the OSCE field office with which they were affiliated. These centers were extremely difficult to manage.

The people of Kosovo are not accustomed to waiting in lines, nor do they have much discipline. In hindsight we did not expect to get the volume of people trying to get through one entry as we experienced. We attempted to establish a Disney World solution to the problem by

building a snake line using engineer tape and wooden posts. The people disregarded these control measures, and the line bulged to 10 and 12 wide. UNMIK-P and KPS attempted to keep order, and for the most part were able to do so, except in a few cases. Many people had to wait for almost 6 hours to vote, but remained upbeat. The smaller polling centers would initially experience large crowds, but saw the crowds taper off towards the end of the day.

The mega centers were still counting ballots at 0530 the next day. Several centers closed, only to reopen an hour later due to confusing guidance from OSCE Headquarters as to whether sites would remain open or closed for late voters. In one instance in the Vitina mega center, the TFF commander, BG Hardy, talked with the voters and was able to calm those who had not been given the chance to vote. There were still about 2,000 voters waiting one hour after the official close of voting due to the process of checking voters and their registration slips. Since none of the voters had received ID cards prior to the elections, the OSCE had to go through the painstaking process of looking through a huge voter list that was not alphabetized and attempt to identify voters by their picture. Many of the polling stations inside the mega centers would be empty because of a bottleneck at the voter control point. The international supervisors managed to stay somewhat calm during the process, but some were overcome with fear over the amount of people and their rising animosity over standing in line for such a long time.

During the after-action review (AAR) with OSCE, it was recommended that the mega center course of action should not be used unless the voting was allowed to run over the course of 2 days and a system was designed to direct voters into the queue for which they were designated instead of standing in one long line.

Voting

The polls were to officially open at 7 a.m. on the day of the election. In most cases this was true. There were isolated incidents of locally hired election support personnel who did not show up at their center until 1 to 2 hours after the official opening. This made it much harder on the international supervisors in getting the site set up and ready to operate.

The mega centers were set up the day prior to the election and then guarded overnight by the UNMIK-P. No weapons were allowed in the

polling centers. UNMIK-P conducted a search for weapons near the door to the center. No political parties could campaign or distribute literature. Many of the parties had representatives at the centers and witnessed the voting process. This was important because it added legitimacy to the process. OSCE tracked voters by marking them with invisible ink to show they voted.

In the MNBE sector there were no cases where a polling center manager had to close a site due to threats or violence. However, there was a situation where ballots intended for Pristina were delivered to the polling center at Kamenica. The Kamenica Head of Field Office had to personally deliver the ballots to Pristina almost 2 hours after the opening of Pristina's polling center. The Ukrainian Special Police Unit, as well as additional UNMIK-P reinforcements, arrived at Pristina's polling center to help control an unruly crowd of voters, who had not been told of the problem with the ballots.

A key asset, which could have helped this situation, would have been the deployment of tactical PSYOPs. TFF PSYOPs teams were equipped with loud speakers and could have assisted in the dissemination of information to the public. This was done at Rogacica, one of the mega centers in Kamenica.

Overall, the UNMIK-P was severely undermanned to handle such large crowds or to communicate with each other. At most centers, the UNMIK-P had only one radio, which made communication between officers next to impossible except for shouting. Some officers purchased hand-held Motorola *Walkabouts* for use within their own teams. UNMIK-P felt that if they had to respond to any kind of emergency at a center, they would not have had the resources to execute a response.

There was only one reported incident of an attempt to steal ballots. This was a phoned-in report to the OSCE Headquarters. It was never verified and classified as a hoax.

Election Support

KFOR stationed in the MNB East sector numbered roughly 9,000 soldiers during the elections. There were no additional assets brought in to the sector to support the current force structure. As a whole, several battalions were brought in to the Kosovo theatre as reinforcements for

the other sectors. A Greek battalion was deployed into the MNB East sector as part of the KFOR reserve, but did not have any command relationship with the Task Force Falcon (TFF) chain of command. Task Force Falcon consisted of six battalions. There were two battalions that were deployed from USAREUR as part of the 1st Armored Division's Ready First Combat Team (1st Bde, 1st AD)—one infantry battalion (1-36) and one armor battalion (1-37). There was an air assault battalion deployed from Fort Campbell (2-327 IN), a mechanized infantry battalion from Greece (507th Mech), a modified airborne battalion from Russia (13th Tactical Group), and a combined mechanized infantry battalion from Poland and Ukraine. Task Force Falcon was also supported by a task force organized aviation package of attack and lift helicopters as well as Ukrainian lift assets.

KFOR Support to the Kosovo Municipal Elections

The Kosovo Force (KFOR) supported the Kosovo municipal elections by ensuring that a safe and secure environment was provided for the voters on election day. This was consistent with KFOR's current mission. As opposed to the municipal elections in Bosnia, KFOR's role in providing direct support to the OSCE was limited.

KFOR support to OSCE included the delivery of ballots by Irish Transport Units and the Greek FSU to OSCE field offices. Units at brigade level and below did not incur any responsibility in moving ballot material. In fact, this was a major issue for KFOR. KFOR did not want to be seen handling any of the ballot material or providing storage so as to not give the Federal Republic of Yugoslavia (FRY) an opportunity to use KFOR as an influencing element. In the TFF AOR, KFOR did provide limited housing for about 59 international supervisors at Camp Montieth and 14 Council of Europe observers at Camp Bondsteel. The personnel were charged 25 DM per night. They were provided transportation to and from the entrance of Camp Bondsteel to their accommodations.

KFOR provided a militarily secure environment for OSCE operations and an opportunity for the Kosovo people to vote in a free and fair election. The OSCE had been operating in Kosovo for 10 months prior to the election and had established a good base of operations. TFF assisted OSCE by providing situational awareness briefings and threat assessments of the polling centers to incoming supervisors.

Task Force Falcon had a liaison team at each of the OSCE field offices with military communications and security. The liaison team's responsibility was to assist OSCE in any emergency requests for support and provide information to the TFF Election Operations Center. KFOR provided training for the international supervisors at Lake Ohrid in mine awareness, first aid, map reading, emergency action procedures, and communications.

Area Security

KFOR's main mission was to maintain a safe and secure environment. The TFF AOR was divided into six battalion sectors over seven municipalities. Each battalion was responsible for the overall security of its sector. During the elections, the units maintained a 150-meter radius from the polling centers so that KFOR would not be perceived as influencing voters. TFF units assisted in providing traffic control points and maintaining an overt presence in those areas where ethnic or party-on-party violence could occur.

Securing Ballots and Counting Houses

KFOR did not provide point security during the movement of ballots from Pristina to the field offices. KFOR did, however, provide an increased presence along the routes over which the Irish Transport Company (ITC) moved. The ITC conducted a reconnaissance of the routes the week prior to the election and established a drop-off and pick-up schedule so that units knew when the ITC would be moving through their sector. The UNMIK-P had the responsibility for providing an escort for the ballot trucks as they moved from location to location. They were also responsible for providing security at the field office locations where ballots were being stored.

Training

KFOR and/or MNB(E) provided emergency evacuation classes during the training at Lake Ohrid. This training encompassed procedures on how to evacuate from a polling center and on where to assemble.

Logistics Support

Task Force Falcon provided various forms of logistics to the OSCE. Most of the missions were *be prepared*, but in essence were still a form of assistance. In one case, a forklift was provided to assist OSCE in moving off-loaded polling kits into a storage facility in the rear of a regional headquarters. TFF gave VS-17 panels to the international supervisors in the event there was an accident or an LZ had to be marked. TFF provided emergency buses in the event that a bus transporting supervisors from Lake Ohrid broke down on its way to the field offices. Medical support was also provided on a life, limb, or eyesight basis.

Noncombatant Evacuation

Under CONPLAN 31408, Credible Haven, KFOR was responsible for noncombatant evacuation of all U.N., OSCE, and international government organizations and non-governmental organizations. Each MNB maintained a list of these organizations and personnel in their sector. It was extremely difficult to keep this document updated. Even when the elections occurred, it was unknown who or how many organizations (other than the U.N. and OSCE) were in the AOR. The OSCE provided TFF with a list of supervisors the night before their deployment into Kosovo, but only after the TFF Election LNO at Lake Ohrid went to the OSCE Deployment OIC. Otherwise the names would not have been available to the units until the buses actually arrived. The Council of Europe did not provide a list of observers until 48 hours prior to the elections.

Another problem was that there were some NGO, UNMIK, and OSCE personnel that were hired as international supervisors. These names were never transmitted to the TFF EOC. The polling centers were not only occupied by the OSCE and Council of Europe personnel, but by political party observers as well. The OSCE had a list of these names, but TFF never received them. Each of the observers had to be issued an identification card identifying them as a local national political observer.

Task Force Falcon EOC was never sure of exactly who was at the polling centers in case there was an evacuation. Only OSCE and U.N. personnel were officially classified as PDSS (Persons Designated Special Status). Locally hired personnel providing direct support to OSCE

during elections were also considered as PDSS based on the seriousness of the evacuation and the capabilities of the KFOR unit. The bottom line was that KFOR would evacuate as many as possible within their capabilities. TFF maintained a list of COE observers and OSCE international supervisors at the EOC.

Evacuation procedures stated that OSCE personnel go to the nearest KFOR location first and then either be transported or directed to a collection point. Once at the collection point, a determination would be made as to whether further evacuation was required.

KFOR OPLAN 32101 Consistent Effort TFF OPORD 00-05 Operation Trinidad

KFOR

KFOR Mission: “KFOR provides support, within capability, to the OSCE during all phases of the 2000 Kosovo Municipal Elections, enabling them to occur without disruption, while continuing operations IAW OPLAN 31402.”

KFOR Commander’s Intent: “Our desired endstate is that elections have been successfully concluded, without major interruption, elected officials are installed, and KFOR operations are seen to have successfully and effectively deterred interruption or violence.”

Task Force Falcon (Multinational Brigade East)

Task Force Falcon: “MNB(E) provides support, within capability, to the OSCE during all phases of the 2000 Kosovo Municipal Elections, enabling them to occur without disruption, while continuing current operations IAW OPLAN 31402.”

Task Force Falcon Commander’s Intent: “The purpose of this operation is to continue to implement the provisions of the MTA and UNSCR 1244, while providing support to the OSCE to facilitate successful elections, and assist UNMIK and other recognized organizations as directed by TFF. The key tasks for this operation include:

- Provide FOM for voters and OSCE personnel.

- Provide support to OSCE within capabilities.
- Conduct polling site recon and provide OSCE with correct grids or assessments on suitability.
 - Maintain a quick reaction force capability.
 - Establish liaison with the OSCE Regional Headquarters and field offices.
 - Adopt an economy of resources policy on other tasks on election day.
 - Maintain communications between unit representatives at field offices and their respective base camps.

End State: “A safe and secure environment maintained; voters provided the opportunity to participate in municipal elections; OSCE supervisors safely depart the MNB(E) AOR; MNB(E), UNMIK-P and MSU personnel return safely to their respective base camps and stations.”

Phases of TFF Operation Trinidad

Phase I

Phase I focused on planning and preparation of the elections. It also encompassed election campaigning by the political parties. TFF established a close liaison with the OSCE Regional Headquarters in Gnjilane, while the battalions coordinated with the field office teams. The biggest challenge during this period was in establishing specific OSCE requests for support and UNMIK-P responsibility for point security. Detailed threat assessments, reconnaissance of polling centers, and communications coverage were conducted in great detail. Each battalion was required to conduct a polling center recon and include a digital photograph, strip map to the site, evacuation routes, a layout of the inside of the building, and grid location information.

Task Force Falcon also conducted a wargame session with OSCE, UNMIK-P, and TFF units and staff. The purpose of this wargame was to allow the different players from each organization to meet and begin working as a team. TFF also conducted a series of situations that the

deploying international supervisors could have faced. This was highly successful and set the tone for the entire operation.

Overall, there was an opportunity for all political parties and candidates to campaign in a safe and secure environment. While there was some early violence (including several deaths), the campaign became much more peaceful during the final weeks. There was some sporadic firing of weapons into the air, especially in conjunction with political rallies. There was fairly good compliance with OSCE electoral rules, although many parties failed to follow the rule of a 96-hour notice for political rallies. Part of the success rests with the efforts of OSCE to train the parties in the electoral rules. Another reason was the strong presence of KFOR and CivPol. While there was little actual violence, there were a variety of dirty tricks that took place. One example was the turning off of electricity at a facility where a LDK rally was being held.

Phase II

Phase II focused on the execution of various tasks in preparation for the election on 28 October. These tasks included delivery of ballot material and polling kits, deployment of OSCE supervisors, activation of the Regional and Field Office Election Operation Centers, and conducting sweeps by MP dog teams of selected high-threat sites. This phase presented many challenges nearer to the election. One particular challenge was setting up polling centers by OSCE the night prior to voting and then providing security for those sites. This was an UNMIK-P responsibility, but TFF provided resources in an overwatch role to observe any suspicious activity at the centers. The mega polling centers presented a major challenge to both OSCE and UNMIK-P. Since there was little or no experience in running centers of such enormous voter capacity, special planning had to be undertaken to ensure the safety and security of the voters and OSCE personnel. Each site established queue control points, traffic control, and security at the doors to the center.

The battalions in MNB-E participated in many rehearsals in the week prior to the election. The rehearsals included representatives of KFOR, OSCE and CivPol. This enabled the participants to raise questions and find solutions. Several region-wide meetings were held to go over the logistics and communications for election day. The meetings were managed well, and participants left with a better understanding of the

process. The international polling supervisors were provided with training and then transported to their respective field offices without incident. A rating system for the level of threat (red, amber, or green) was determined for each of the polling centers. However, the threat level for some areas of the region were based on less than optimal information due to the reluctance of some battalions to cooperate fully. This information was used by CivPol to plan point security and for KFOR to plan area security.

Phase III (28 October) Election Day

A safe environment was provided for all voters. There was no violence on election day. Without any serious incidents, there were no injuries to voters, observers, or media. There were no complaints filed with the Election Complaints and Appeals sub-Commission contending vote fraud nor did independent election monitors cite any instances of fraud. Independent monitors reported few instances of intimidation or political campaigning in or around polling locations.

Overall, the polling staff performed well. All of the staff received some degree of training. There were no significant complaints filed with the Election Complaints and Appeals sub-Commission for breaches in electoral rules by polling station staff or significant violations observed and reported by election monitors. There were some problems with the queue controllers in that they were not forceful enough in controlling the crowds. Better selection of controllers and better training will be needed in the future. Of concern was the performance of the mega centers. The processing of the people prior to voting took far longer than expected at some of the centers, creating large crowds of waiting people. Part of the problem was that some people did not have their registration slips, which greatly increased the processing time.

Domestic election monitors, international election monitors led by the Council of Europe, and accredited news organization representatives were present at every step of the election day process. Neither the media nor independent monitors filed complaints regarding access to polling centers.

The voters were given every opportunity to cast their ballots. Although the polling stations were supposed to close at 7 p.m., many remained open because of the long lines of waiting voters. The last voter in this

election cast a ballot in the very early morning hours of October 29. Voter turnout projections indicate that about 80 percent of registered persons actually voted, which is outstanding.

Overall, OSCE did a good job with election logistics. However, problems did exist. In a few of the polling centers, there was a shortage of ballots or other election supplies. The wrong ballots were delivered to one polling center. However, when problems were identified early on, they were immediately addressed and quickly rectified.

The communications system was mediocre at best. There were problems with the radios used by OSCE. KFOR assisted with the communications used on election day by providing some equipment and associated personnel. KFOR communications were fairly good. It may be necessary to make improvements to the infrastructure before another election is held.

RJEOC on Election Day

The RJEOC in Gnjilane served as the operations center for MNB-E on election day. It was located in the OSCE regional office. Those present on election day included the KFOR LNO, the UNMIK Police LNO, and most of the OSCE regional staff. The overriding goal was to ensure that a safe environment for the election was provided for voters.

This does not mean that the RJEOC did not have to contend with a variety of smaller, yet still significant problems. One continuing concern was the crowds that were created by the slow processing of voters at the mega centers. It was necessary to send more UNMIK police to these centers to assist with crowd control.

The RJEOC was the communications hub for all of the polling centers and for the OSCE field offices, UNMIK police, and KFOR units tasked with providing security. One problem with communications concerned the closure of the polling centers. While the polling stations were supposed to close at 7 p.m., the RJEOC ordered the centers to remain open because of long lines of waiting voters. Some centers never got that instruction, while others misunderstood and actually tried to close the centers at 7 p.m. It took several hours to resolve the situation. The RJEOC stayed open until all of the ballots were returned to the field offices, which took place in the very early morning of October 29.

Overall, the RJEOC functioned well considering that about 80 percent of registered persons actually voted. There was no violence or serious incidents involving voters, observers, or media. While there were some difficulties, OSCE, KFOR, and the UNMIK police were flexible enough to make adjustments and adequately address all of the election day problems.

Phase IV—Implementation

The election concluded with the swearing-in of elected officials. There were several municipalities that initially refused to take part in the swearing-in until the Albanian National flag was present. The United Nations at first insisted that only the U.N. flag would be flown at the ceremony, but backed down in an effort to finalize the election.

Summary

The Kosovo elections took considerable time and effort by the OSCE and the United Nations to plan and execute. It was certainly without a doubt the most significant event to occur during the occupation by KFOR. Staff and personnel of both the OSCE and the U.N. had the necessary experience and knowledge to make it happen. While both KFOR and OSCE were faced with a multitude of challenges, the teamwork between both organizations proved that the military, working alongside international organizations, could be effective in helping restructure and restore civility to an area that has virtually none.

The following personnel assisted in this summarization of the Kosovo elections:

Major Ivan Shidlovsky, GS, Deputy G2, 1st Armored Division
(G2 Plans, Task Force Falcon, 2A Rotation)

Major Kerry MacIntyre, GS, Chief, G3 Plans, 1st Armored
Division (G3 Plans Chief, Task Force Falcon, 2A Rotation)

**SECTION 3—AIR WAR
AND RELATED
MEDIA CHALLENGES**

CHAPTER VI

Air War Over Serbia

Patrick Sheets

Operation Allied Force, the air war over Serbia, represents the most significant military action NATO has taken in its 50-year history. It also represents an inevitable shift in the Revolution of Military Affairs. For many reasons, not to be discussed in this chapter, the North Atlantic Treaty Organization (NATO) chose to use military power to project its political will on another sovereign nation. The fact that NATO and the United States, as primary contributor, chose to use aerospace power exclusively will be discussed in depth in this chapter along with several other important indicators about future military operations.

Why an Air Operation Only?

Imagine taking on the bully in your neighborhood and before the confrontation were to take place, you told him you were not going to use your fists and that he probably would not even see you. Yet you told him you would continue to punish him until he stopped being a bully. This is exactly what the United States and NATO chose to do in its plan to save the Kosovar Albanians. Without debating the connection between the inhumanities taking place in Kosovo and U.S. national interest, we can certainly tie our involvement in the Balkans to our ties with NATO and the European Union and from there, tie them to national interests. But this connection is one politically challenging to sell to the American people as a reason to have our sons and daughters dying in combat. So how do we go about doing both, stopping the bully and not lose sons and daughters while doing it. The choice was aerospace power.

In the evolution of our nation and the revolution in military affairs, air power has become the primary tool of choice. It does not matter whether this power is projected from the CONUS, from deployed bases, from

carriers, or from space; it has been and will always be the most efficient and effective way. It is this inevitability that drove the Nations leadership to choose aerospace power to accomplish its political objectives in the Balkans. The real question is: why tell the bully you are not going to use ground forces to attack him?

The answer might possibly be the fear of threatening him with a military capability we had no will to use. Or it might be we had no intention of exerting the resources required to pose the threat we had no will to use. Either way, we chose not to threaten Milosevic with anything but an asymmetric attack. An aerospace attack that took 78 days to meet the political objectives stated at the beginning. Why it took 78 days and why he capitulated are areas I will discuss later in the chapter. Once the asymmetric decision was made, the next most significant factor in executing the air war was to do so in an alliance.

The difference between a coalition and an alliance is fairly significant and certainly posed many challenges to the execution of Operation Allied Force. In a coalition force, like the one used in Operation Desert Shield and Storm, the relationship between participants is one determined by the task at hand and worked out prior to the members joining. The coalition exists because Nations have agreed to work together to meet a political objective and subsequently, agreed upon military objectives. Coalitions by this definition are temporary in nature and will come and go as the military and/or political tasks are met. Alliances, like NATO on the other hand, are long standing relationships among nations that may or may not have military ties. NATO definitely does because it is an alliance of now 19 nations, originally based on a collective defense relationship. Specifically, after World War II, NATO became an alliance pre-establishing the commitment of the member nations to come to each other's defense in case of attack by any other non-member country. Although there were many other compelling political and economic factors that made up the articles of agreement between the nations, Article 5, the article establishing collective defense, is one most significant to the military.

Collective defense has always been the direction and focus of NATO military equipment, training and sustainment for the past 50 years. For the alliance to choose to go offensive and strike the first blow was a huge paradigm shift for the alliance nations. Additionally, the pre-determined relationship of the alliance member nations was one of consensus and equal voice, no matter what the level of contribution.

This too, provided additional coordination and approval challenges to issues of targeting and employment, which would normally not exist in a coalition.

The point to be made is, Operation Allied Force was an extremely frustrating military campaign to wage because of the intricacies of the NATO Alliance and its 19 nations. The political-military structure of this alliance required target approval from 19 separate national capitals. To this end, we must acknowledge the fact that the NATO Alliance was much more challenging environment in which to operate a military campaign than it would have been in a coalition.

Incrementalism

The word *incrementalism* is not one found in the warfighters dictionary. It falls somewhere near the word *hope* as something you never want to be used in the planning process. To have hope is one thing, to build your plan around it is dangerous. Once a decision is made to use military power to meet the political objectives, the application of this power should not be incremental. Incrementalism is contrary to all the basic principles of warfare, like shock, mass, and momentum. Incrementalism is not contrary to the political decisionmaking processes.

Acknowledging the complexity of the Alliance and the indirect U.S. national interest ties to the Balkans, it is easy to see why this politically directed military application was so controlled. Incrementalism like any other *ism* can be a double-edged sword that requires tremendous skill to use. The perceived balance to be maintained in this incremental application of military power was the vulnerability of the Alliance to remain intact versus the time required for the use of military power to be effective in meeting the political objectives. This reality manifested itself in many areas of the air war like targeting and the master attack plan. Most would argue it certainly was responsible for the 78 days it eventually took aerospace power to meet the political objectives.

Command and Control

The strategic to operational command and control structure for Operation Allied Force was centered on the existing NATO chain but had many deviations that produced challenges both nationally and in

force application. The theater U.S. National and NATO chains of command are depicted in Figure 1. The two chains are linked with a common commander, Gen Wesley Clark who is both Supreme Allied Commander Europe (SACEUR) and Commander-in-Chief of U.S. European Command (USCINCEUR).

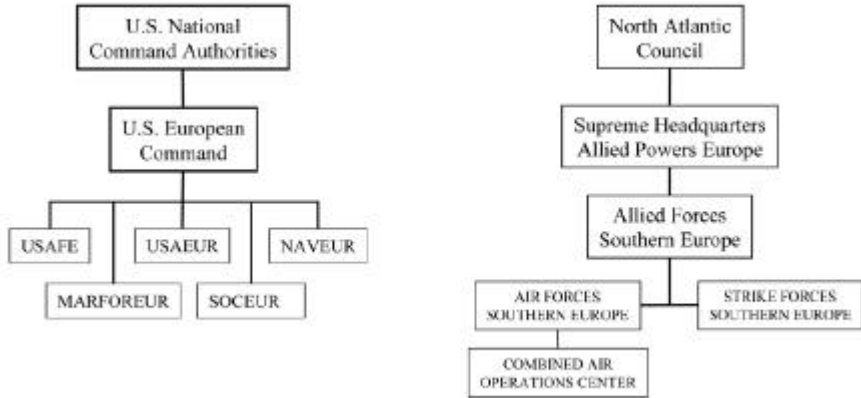

Figure 1. U.S. and NATO Chain of Command

In early 1999 USCINCEUR created Joint Task Force (JTF) Noble Anvil to support the NATO operation. Figure 2 shows the addition of this U.S. only chain of command that was in place when the bombing started on 24 March 1999. This is a non-traditional arrangement and was new to both NATO and the U.S. Air Force. Additionally, Figure 2 shows the command inputs to the traditional aerospace tasking process that results in the Air Tasking Order.

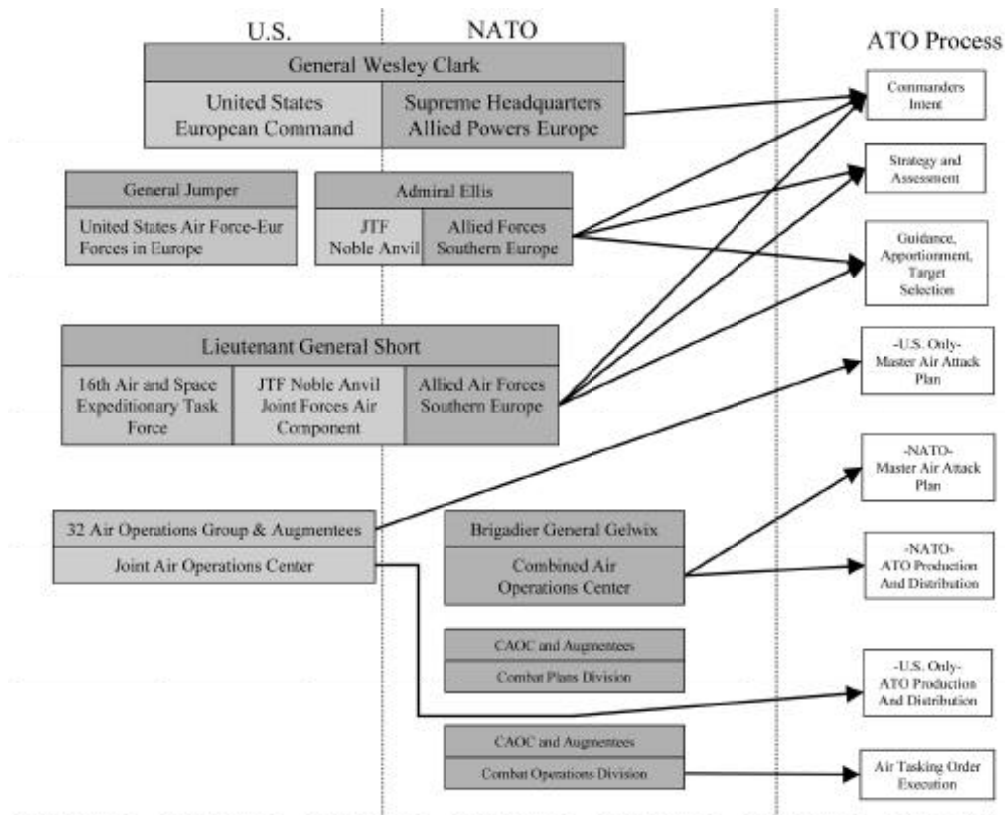

Figure 2. Operation Allied Force Organizational Structure—Planned

The first 2 days of bombing that constituted the U.S. and NATO initial plan failed to produce its desired effect. Not only did Milosevic not stop his systematic operation to cleanse Kosovo of all ethnic Albanians but also he intensified the operation. This was vividly evident in the ensuing refugee crisis facing NATO. With the number of refugees mounting in Albania and Macedonia, USCINCEUR tasked U.S. Air Forces Europe to create JTF Shining Hope to conduct humanitarian assistance operations supporting U.S. government agencies, non-governmental agencies and international organizations. While JTF Shining Hope was beginning to bring needed supplies to the refugees in Albania, USCINCEUR directed the deployment of 24 U.S. Apache attack helicopters and a full command and support element from Germany to Albania, as Task Force Hawk. The addition of JTF Shining Hope and TF Hawk to the U.S. chain of command added additional elements to the already complex command and control structure as seen in Figure 3. This resulted in hundreds of fixed wing aircraft, helicopters, missiles, and unmanned aerial vehicles operating in the same congested airspace over Southern Europe, but not under a single chain of command. Both NATO and U.S. Joint Doctrine call for a JFACC to be both the Airspace Control Authority and the Area Air Defense Commander to ensure coordinated and safe use of the airspace through out the Joint Operating Area, including Air Defense. By the first of April the lack of unity of command based on this non-standard and non-doctrinal command structure jeopardized the JFACCs ability to perform these vital missions.

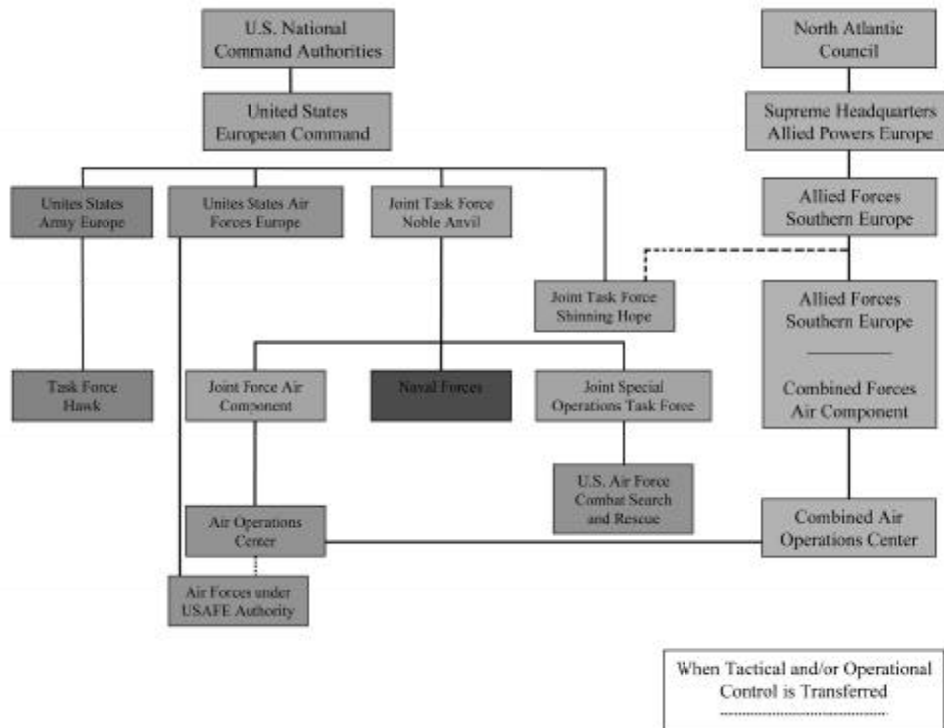

Figure 3. JTF Organizational Relationships

Of greater concern, was the target approval process and this along with separate U.S. and NATO air tasking orders led to the complicated and difficult air tasking order process shown in Figure 4.

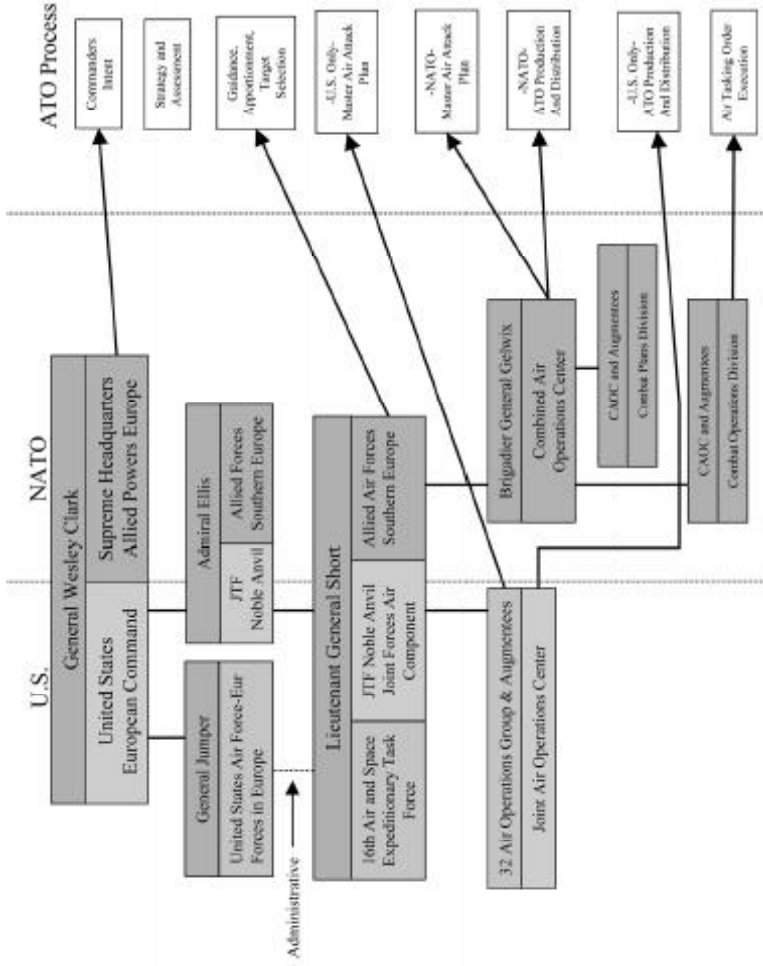

Figure 4. Operation Allied Force Organizational Structure—Actual

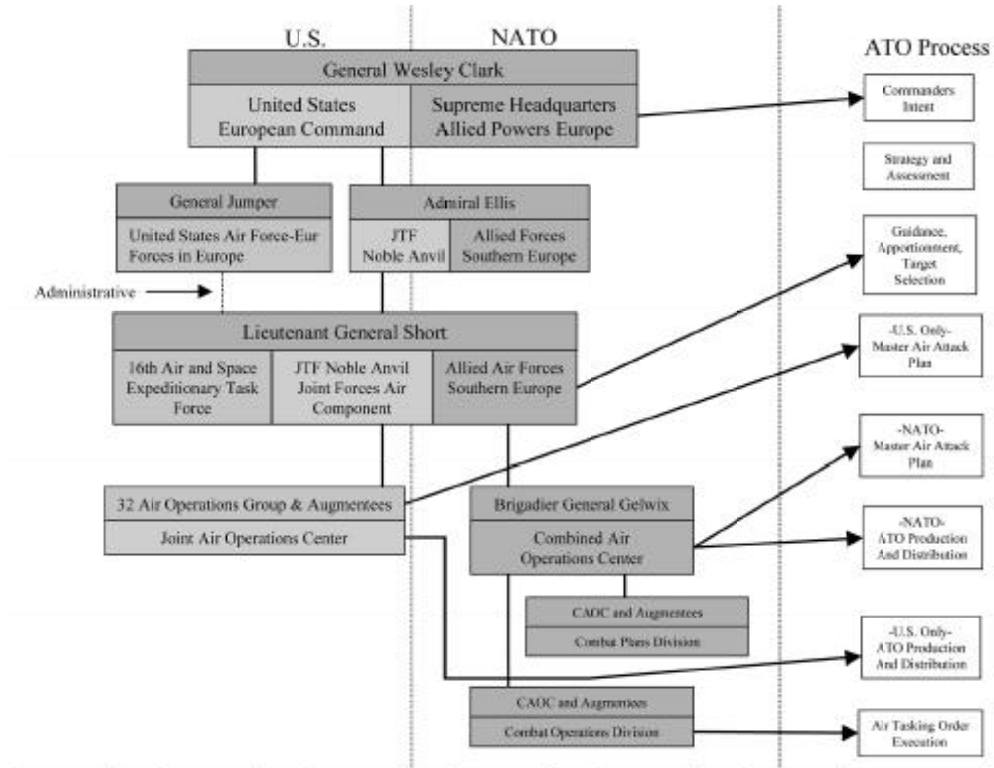

Figure 4. Operation Allied Force Organizational Structure—Actual

Of greater concern, was the target approval process and this along with separate U.S. and NATO air tasking orders led to the complicated and difficult air tasking order process shown in Figure 4.

The combination of deploying forces from the CONUS, deploying TF Hawk, and providing humanitarian assistance through JTF Shining Hope created tremendous mobility commitments for U.S. air forces. Additionally, there were traditional command elements missing from both the NATO and U.S. structures which made the execution of the air war over Serbia extremely challenging from the aspect of supported and supporting command elements. The key elements missing were a Joint Forces Maritime Component Command (JFMCC) and a Joint Forces Land Component Command (JFLCC). Although there were command elements for these forces through the force provider chain of command under the European Command in the form of U.S. Naval Forces Europe (USNAVEUR) and U.S. Army Forces Europe (USAREUR) and these forces participated in operations within the Joint Operating Area, there was not an established component command relationship within the operational plans or the command structure to provide direct support to the Joint Forces Air Component Command (JFACC) as the de facto supported component command. To exasperate the unity of command challenges, TF Hawk, although operating as an Army element within the joint operating area, was not even under the command of the JTF Noble Anvil commander responsible for leading the execution of Operation Allied Force and Noble Anvil. Instead TF Hawk reported directly to U.S. Army Europe and then to USCINCEUR completely bypassing the tasked warfighters in both the NATO and U.S. chains of command.

78 Days of Aerospace Warfare

At 7 p.m. Greenwich Mean Time on 24 March 1999 NATO forces began air operations over Serbia in Operation Allied Force. NATO's opening attack demonstrated its technical sophistication. The initial target set reflected the Alliance's belief that the war would end quickly. NATO's aerial strike package included aircraft from the 13 nations, including B-2s, B-52s and Tomahawk Land Attack Missiles. The incremental approach to this military operation resulted in the incremental flow of assets into theater over the next 2 months. When the air war started, the Combined Air Operations Center, the command and control center for the Joint Forces Air Component Commander, had 214 combat aircraft under its control, of which 112 were from the United States. These aircraft attacked from bases in Italy, Germany, the United Kingdom and the United States. On the first day of the conflict NATO showed its air superiority by shooting down three MiG-29s, Serbia's most advanced fighter.

As the conflict grew in early April 1999, more than 350 NATO aircraft were engaged with 200 of them being from the United States. At NATO's 50th Anniversary, held in Washington D.C., 23—24 April 1999, national leaders expanded the target categories allowing intensified military actions that increased pressure on Belgrade. Nonetheless, NATO was unable to immediately coerce Milosevic to stop Serbia's campaign of ethnic cleansing. On 1 May 1999, as recommended by NATO's leaders at the Washington Summit, the North Atlantic Council approved yet another expanded target set. At this point, the JFACC was flying approximately 200 combat sorties a day. Targets such as petroleum refineries, lines of communication, electrical power grids and dual-use communications structures were now more readily approved and systematically targeted. Striking them greatly increased pressure on the Yugoslavian population and, in turn, the Serbian leadership. A better appreciation was also emerging for what would be required to bring the conflict to a successful conclusion. From this point forward, objectives remained relatively constant for the rest of the war.

With this change in the war's scope, momentum grew at NATO headquarters to increase the number of fighter and bomber aircraft available to Operation Allied Force. SACEUR's guidance called on NATO to intensify the bombing and put pressure on Milosevic to withdraw from Kosovo. This also began to accelerate the target nomination and approval process. However, NATO aircraft could still destroy targets faster than targets were developed and approved. By the later stages of the war NATO had enough aircraft in the theater to generate some 1,000 attack sorties per day, but never did—largely because of the limited number of approved targets.

The Combined Air Operations Center (CAOC) at Del Molin Air Field, Vicenza, Italy, went through a similar metamorphosis based on the incremental growth of the air war. At the beginning, the CAOC was manned at approximately 400 personnel capable of executing a 100—300 sortie a day operation. By the end of the war on 10 June 1999, the command center manning grew to over 1,400 personnel. In concert with this growth was a parallel requirement to completely reorganize the airspace and associated control procedures, which were originally designed back in 1995, for Operation Deliberate Force, the NATO support to Bosnia-Herzegovina.

Because of the dual chain of command, U.S.-only and NATO, the CAOC planned in a similar manner. Additionally, because of this dual planning and perceived Operations and Communications Security breaches, the JFACC approved a two-air tasking order process. This decision to fence U.S. high value combat assets on a separate air tasking order, in retrospect, was not worth the confusion and execution challenges it generated. Here is what Lt. Gen. Short said about this issue in his address to Air Force Association 25 February 2000. “Publish a single ATO (Air Tasking Order). Not doing so was a mistake we made. On the first night of the war, as the F-117 force was forming up in Hungary with its escort, a foreign national was screaming from the NATO AWACS (Airborne Warning and Control System), asking the Combined Operations Center ‘what were those planes doing in Hungary?’ We had a U.S.-only ATO and NATO ATO, and that young man on board NATO AWACS did not have the U.S.-only ATO. Clearly we have concerns for technology, and we have concerns for timing. But you don’t ever want to be put in a position where on the first night of the war, sitting at a table of the JFACC, and a flag officer from one of your strongest allies says, ‘General, it appears to us we are not striking the SA-6s at location A, B, and C.’ And the best you can do is say, ‘Air Commodore, trust me.’”

As the character and the direction of the war changed, so did the restrictions on altitudes. Because the war’s initial attacks were against fixed targets, at night, using precision-guided munitions, Gen. Short ordered all attacking aircraft to remain above 15,000 feet in order to negate the effectiveness of Serbia’s short-range air defense systems. This was consistent with guidance from SACEUR. By mid-April NATO leaders had increased the emphasis on attacking fielded forces. This coincided with an increase in the number of daytime sorties and reduced air defense threat over Kosovo. At the same time, the Serbian military had begun intermingling its forces with the civilian refugees and hiding in urban areas. As a result, airborne forward air controllers requested that altitude limits be lowered to positively identify vehicle types. Gen. Short agreed to allow certain aircraft to fly at lower altitudes. While flying at high altitudes had been cited by some as the reason for the inability to kill tanks and fielded forces, finding, fixing, tracking and targeting dispersed forces proved a challenging task at any altitude.

Targeting and Suppression of Enemy Defenses

The Joint Suppression of Enemy Air Defenses (JSEAD) executed in OAF was effective in allowing freedom of air movement in Serbia meeting the aerospace objective of air superiority, but was not effective in destroying all enemy air defense systems (DEAD), which would have led to air supremacy. There were two overarching reasons for this reality. The first has to do with the concepts and application of effects based targeting and the other has to do with the adversary's integrated air defense system tactics learned from previous U.S. and Coalition operations going back as far as the Gulf War.

The effects based targeting issue is one dealing with the difference between developing a master air attack plan (MAAP) with specific military objectives based on sound warfighting principles or just hitting random targets for the sake of some other effect. The MAAP takes military objectives, derived from the political objectives, and formulates an aerospace attack plan with sequels and branches. This plan is focused on specific effects desired then designating the appropriate targets, to reach the desired effect. The effects based approach uses a complex building block concept where one effect of successfully hit targets flows into the next set of targets. This sequential flow could be measured in hours and/or over days and weeks, based on the size and intensity of the MAAP. The political-military process for targeting and target attack approval generated disconnects between effects based objectives and just servicing a target list based on what was approved. The reality of OAF was, many of the key targets required for the air supremacy objective were not available to be struck, at the beginning of the war. Some of these targets never made it on the cleared list, even by the end of the war. This happened because the initial political objective of NATO was to get Milosevic to cave-in and sign the agreement and not the aerospace objective or air supremacy that is well founded in both Joint and Air Force Doctrine. There are some who would say the targets to be struck to meet the effects based concept were too risky in terms of collateral damage or damage to the Serbian national infrastructure. Not to argue this or the adverse effects of collateral damage on the Alliance, the reality is the political effects desired from the incremental entry into the aerospace war with Serbia were not forthcoming, yet the effects based opportunities desired from the initial proposed targets quickly became unavailable due to enemy reaction to the bombings.

As for the adversary integrated air defense system, the Serbs have learned well from previous U.S. and Coalition application of Joint SEAD tactics and techniques. Even though NATO was faced with second generation Soviet built surface to air missiles (SAM), several of these systems still survived and posed a sufficient level of threat to be bothersome to aerospace operations and force the Alliance to allocate a tremendous number of sorties and munitions against them, all because of their tactics. The Joint SEAD concept of operations for OAF consisted of two primary assets, the F-16 CJ, capable of shooting the High-altitude Ant-Radiation Missile (HARM) and the Navy/Marine/Air Force EA-6B Electronic Warfare (EW) jammer. In concert, they provided pre-emptive and real-time missile defense from the F-16 CJs and radar/target tracking denial from the EA-6Bs. The tactics the Serbian SAMs used to survive and continue to pose a potential threat to NATO aircraft are the same tactics that made the Serbian SAMs ineffective. Thus NATO operated at will with air superiority, but required the F-16 CJs and EA-6Bs to do so. Had NATO achieved air supremacy by the total destruction of the enemy air defense system (DEAD) and eliminated all medium and high altitude SAM threats, then the execution of strike packages would not have required continuous SEAD.

Attacking Mobile Targets

The air war over Serbia presented a complex scenario for an air-only operation to efficiently and effectively target fielded forces. The complexity of targeting both moving and/or mobile targets can be broken down into three interrelated components. First is the tasking process, second is the finding and fixing of the targets and third is the tactical level of command and control to positively identify the targets as enemy and execute the attack.

Whether Milosevic's 3rd Army in Kosovo, was a center of gravity or not, the desire to attack these fielded forces in Kosovo became a military objective. This objective may not have been written anywhere but the tasking of aerospace forces to attack fielded forces in Kosovo was certainly the number one topic in the command video teleconference (VTC) after the initial two days of air strikes did not produce their desired outcome. The tasking of aerospace assets to engage mobile targets requires tremendous flexibility. From the targeting standpoint, this flexibility is not inherent in the standard fixed target planning

process that historically starts 72 hours out from the air tasking order (ATO) day of execution. The assets used to strike mobile targets are dynamically tasked from predetermined strike missions programmed into the ATO. These strike missions may have had secondary targets assigned to them to be hit if a mobile target was not available during their mission. Some missions did not have any secondary targets and if no targets were available for them to strike during their mission then they would return to base with their ordinance. The tasking process for the 78 days of the air war was not a limiting factor to the JFACC's ability to kill mobile targets.

The finding/fixing component of attacking mobile targets on the other hand was the toughest challenge. The environment in Kosovo included unfavorable weather, heavy foliage, variable terrain and lots of buildings to hide armored personnel vehicles (APV), tanks and artillery in. Without an opposing ground force, the 3rd Army in Kosovo did not have to concern themselves with a ground attack other than the small forces of the Kosovo Liberation Army (KLA) in Mt Pastric. Thus their maneuver and defensive posture was only against attack from the air. This asymmetric alignment of a fielded Army with an ineffective air defense system and an air force free to roam above them forced the Serbian Army to disperse and hide wherever they could to avoid being attacked from the air. This dispersal would have made the 3rd Army ineffective as a fighting force had they been opposed by a credible ground force. But the reality of their presence in Kosovo was not about defending the area from attack but as a supporting force to the paramilitary police executing Operation Horseshoe, which was the Serbian operation to systematically purge Kosovo of all ethnic Albanians. The asymmetric alignment of a ground force executing an operation of harassment and terror on the ethnic Albanians and an opposing air force attempting to strike them was surreal. But this was SACEUR's expectation when Operation Horseshoe intensified after the second day of bombing and it was evident the ethnic cleansing operation was not going to be stopped.

The JFACC became very inventive and put a tremendous effort into attacking the fielded forces in Kosovo. A combination of flying airborne forward air controllers (AFACs) primarily in A-10, F-14, and F-16 aircraft, unmanned aerial vehicles (UAVs) and a variety of other sensor capabilities were all focused on finding and fixing mobile military targets to be attacked. The concept of operations emulated the doctrinally

founded close air support (CAS) concept that uses aerospace power to support the attack of fielded forces in contact with friendly fielded forces. CAS uses both airborne and ground based forward air controllers (FACs) to provide the attacking fighters situational awareness on the location of their targets and the location of friendly fielded forces. CAS provides close control of air strikes to maximize application of air power against the enemy and minimize the possibility of fratricide (killing friendly forces). The JFACC and his AOC used air FACs exclusively during the air war because there were no friendly fielded forces in contact with the enemy and subsequently, there were no ground FACs. Without friendly fielded forces in contact with the 3rd Army in Kosovo, the JFACC had to rely on cross cuing a variety of inputs like Joint Surveillance Target Attack Radar System (JSTARS), with its moving target indicator (MTI) radar, UAV video, satellite with high altitude imagery and human intelligence to find and fix enemy fielded forces. Finding the fielded forces was one task, but to geographically fix (pinpoint the exact position on the earths surface by using Latitude and Longitude in degrees) was even a greater challenge. The air FACs would fly over Kosovo to seek out and target fielded forces. Their ability to do so was only as good as the cross cuing information they took off with or received while airborne from either the Airborne Warning and Control System (AWACS), the Airborne Battlefield Command and Control Center (ABCCC), or the JSTARS. Outside of good cross cutting the only opportunity air FACs had to target enemy fielded forces was when the enemy showed itself while an air FACs was in the area. These opportunities were few because of the Serbian Army's situational awareness of the NATO air operations and the asymmetric alignment of air versus ground forces.

The rules of engagement for attacking fielded forces were as restrictive as those we would use for CAS. These restrictions applied because of the possibility of inflicting collateral damage to noncombatants in Kosovo. These restrictions were the primary reason for the perceived success of the 3rd Army in Kosovo. They continually used these rules of engagement to their favor by only moving in mixed formations with noncombatants and locating their military vehicles and armor in populated areas where, if they were attacked, they knew there would be collateral damage. By 1 April, NATO was struggling with 100,000 plus refugees who were being forced out of Kosovo into Albania and Macedonia and 40,000 to 50,000 refugees who were displaced from

their homes and villages, but were not allowed to leave Kosovo. These refugees were referred to as internally displaced persons (IDPs). The whereabouts of IDPs within Kosovo was a continual concern of the JFACC and became an important factor to the process of attacking enemy fielded forces in Kosovo. The inadvertent targeting of a convoy of IDPs on 14 April 1999 near Djakvica was a painful example of the challenges of finding, fixing and attacking enemy fielded forces. Even with all the rules being followed, misidentification can occur.

Why Did Milosevic Capitulate?

This is the million-dollar question every analyst of the Kosovo conflict has been pondering. If you retrace the sequence of events starting with the previous bombing of the Serbs in 1995 over the atrocities taking place in Bosnia-Herzegovina, then recognize Milosevic backed down in the fall of 1998 to the imminent threat of bombing which led to the Ramboulet talks. It is easy to see why NATO and the United States expected a short conflict again. Milosevic proved to be much more complicated and calculating this time. Without hearing the facts from Milosevic, one can only attempt to rationalize the factors and try to theorize why he capitulated to a more stringent agreement than he would have had at Ramboulet, after 78 days of bombing by NATO. To think it was just the bombing would be as foolish as thinking he would have capitulated after the second day of bombing. To focus on centers of gravity like the national infrastructure, external political support and internal political support would be more realistic. Or look at in the reverse, where our primary center of gravity the Alliance, which Milosevic targeted in every way possible, did not break. With NATO's resolve intact, Milosevic had only two options: continue to absorb punishment, or accept NATO's demands. He chose the latter.

The Future

The true challenge of lessons learned from such a geopolitical military operation is to visualize the way forward and not make it out to be an extension of what you just experienced or worse, to use the previous experience as self-justification. The flight path of the Air Force is based on a global perspective outlined in *Joint Vision 2010* and expanded by the services *Global Engagement: A Vision for the 21st Century Air*

Force. The operational concepts within this vision will lead to the ability to find, fix, track, target, engage, and assess anything of importance in the world in 1 hour or less.

CHAPTER VII

Operation Allied Force: Air Traffic Management

Paul Miller

Introduction

The conduct of the NATO Operation Allied Force against the Federal Republic of Yugoslavia (FRY), coupled with associated air operations, including humanitarian airlift, highlighted the necessity of close civil-military Air Traffic Management (ATM) coordination at all levels of command and control. For the first time since the formation of NATO, large-scale offensive and combat support air operations were conducted in Europe that had a significant impact on civil air operations on a scale that far exceeded those of the Bosnian campaign. There have been some significant lessons learned in terms of operating procedures that will hopefully be applied in the future.

Background

The 1990-1991 Gulf Crisis represented the first post-Cold War large-scale movement of reinforcement and combat traffic crossing Europe in significant quantities. Given that this occurred a short time after the fall of the communist regimes of Eastern Europe and coincided with the relatively low levels of civil air traffic during the winter period, the impact on the civil route structure of Europe was minimal. In addition, the area of operations for the coalition forces was outside Europe and the military traffic flow consisted of strategic air assets en route to and from the area of operations. While there were extra demands on the ATM systems across Europe, they managed to absorb the extra traffic satisfactorily.

In the mid-1990s, the Bosnian crisis generated a general increase in military traffic over southeastern Europe. In 1994, in support of the

United Nations Security Council Resolutions establishing a no-fly zone over Bosnia-Herzegovina, NATO forces were committed to combat air operations over the Balkans, which also entailed closing portions of Italian airspace over the Adriatic. These operations naturally disrupted the flows of civil traffic and for the first time saw significant shifts to the traffic flows through the nations of the former Warsaw Pact. In addition, the involvement of non-NATO nations in this form of operation was evident for the first time in post-Cold War Europe.

As far as ATM was concerned, the Bosnian conflict demonstrated the growing requirements for closer international cooperation and coordination. In 1994, the EUROCONTROL Central Flow Management Unit (CFMU) became operational and, in due course, enabled a coherent plan to be drawn up to coordinate both the re-routing of the civil traffic and the sequencing of the military support airlift into the region. This capability was to prove invaluable.

Operation Allied Force

Operation Allied Force was conducted as a non-Article 5 Operation, which precluded the full implementation of the NATO Precautionary System that is planned and intended for Article 5 situations covering only direct threats or attacks on NATO member nations. The operational contingency planning that was initiated in the middle of 1998 took little account of the requirements of the complex civil air route structures that have evolved in Europe since the end of the Cold War. As the planning progressed to match the political mandates that were being established, the NATO International Staff, in particular the Air Defense and Airspace Management Directorate (ADAM), emphasized to the NATO Military Authorities that it was essential that coordination mechanisms were put into place to ensure that:

- military forces had access to the required airspace to conduct operations; and
- civil en route operations experienced the minimum of disruption commensurate with flight safety.

To further complicate matters, a large-scale humanitarian airlift operation was put into effect at a very early stage of the operation against the

FRY. Since this airlift took place within the area of combat operations, an already complex air situation was complicated even further.

Finally, the activities of aircraft operating into and out of Belgrade on political VIP and humanitarian missions required a great deal of additional coordination to prevent any unnecessary air interception and possible engagement. While it would appear that the provision of this kind of operational support should be relatively straightforward, there were several organizational constraints. Above all, the way which civil ATM has evolved in Europe during the past decade, especially with the centralization of air traffic flow management, has meant that the traditional concepts of a completely national or NATO militarily controlled air environment are no longer valid in the context of such operations.

Participants in Civil/Military ATM Coordination

The civil-military coordination required to integrate all the airborne participants in the operation was not clear-cut. As a first step, the organizations involved in the planning and subsequent implementation of the procedures had to be identified and then the information flows and respective responsibility centers could be established.

Civil Organizations

The civil organizations involved in the civil-military use of airspace are placed at two levels, international and national.

Within the general framework established by the International Civil Aviation Organization (ICAO), the principal European ATM organization at the international level is EUROCONTROL, whose Headquarters is located in Brussels. The Flow Management Division (FMD) of the EUROCONTROL CFMU has the responsibility for maintaining the coherence of the civil air route structure and traffic flow throughout some 39 European countries and consequently, any impact on that structure has to be analyzed at the pan-European level. As an example, if a nation requests a relaxation to the restrictions on its airspace or routings as agreed with NATO, the request would be examined by the FMD to assess the impact on the overall route structure. EUROCONTROL also coordinates with the ICAO European

Regional Office in those cases where civil-military airspace or route issues may need to be addressed.

Arrangements concerning the use of sovereign airspace of non-NATO Partnership for Peace Nations by NATO forces were negotiated on a bilateral basis between NATO and the country concerned. The resulting impact of these activities on the airspace for other airspace users naturally had an effect on the overall international ATM environment.

Military Structures

The military structures that needed to be involved in ATM coordination were, once again, both multinational and national. In a NATO-led operation, the NATO Air Command and Control (NAC2) organization at all levels must interact within the planning and coordination processes. It is inconceivable that any future operation will not have an impact on the civil aviation environment and both the initial planning and the execution of operations will require appropriate degrees of cooperation and coordination. This cooperation required dialogue at both political and operational levels with national civil and military authorities.

Legal Aspects

The importance of political and legal advice at all levels of planning and during the operation was crucial. From NATO HQ came the political guidance necessary for the application of legal contacts with those nations involved in the operation. This was highlighted by the bilateral agreements that were necessary between NATO and non-NATO nations to establish a legal basis for the use of facilities and airspace. It is also apparent that nations have very different mechanisms and timelines within which to ratify any agreements reached with NATO. These factors became an essential element of the development of any modifications of the overall international ATM airspace/routing scheme during Operation Allied Force.

Legal advice was necessary at all levels of these negotiations from the Legal Advisor at NATO HQ, through SHAPE and subsequently the commander in theater. Consistency in this advice was crucial and had to reflect the substance of international agreements affecting civil aviation.

Procedures for Civil-Military Coordination

In initial planning, the political and military planners needed to be aware from the outset of the importance of involving not only the nations directly affected, but also the international civil aviation community through either EUROCONTROL or ICAO. This relationship was included into the pertinent operations orders and subsequently in the more detailed operational planning phases. Additionally, direct contact was established with these organizations to permit examination of existing contingency arrangements and to initiate any necessary refinements on a case-by-case basis at short notice. Also, representatives of the International Air Transport Association (IATA) were contacted to provide a liaison, when appropriate, with the major civil operators.

As operational planning progressed, the involvement of the various levels of the NATO C3 chain relating to air operations and the impact on ATM needs were continuously examined. These entities included the NATO Air Traffic Management Center (NATMC) structure, the International Staff (particularly the ADAM Directorate), the International Military Staff, and the NATO Military Authorities down to the Combined Air Operations Center (CAOC). The interrelationships between the entities required a review of the definition and action checklists. It was obvious during the operation that the personal relationships developed between the eight or so players in the civil-military ATM coordination roles were more important than the minimal procedures then in place. The pace of the operation, combined with the dynamics of the overall air situation, called for continuous crisis management actions to be implemented.

The NATO, particularly the NATMC, structure has given evidence of its flexibility and responsiveness during the Kosovo crisis. It has to be said that as in most crisis situations, it is the personal relationships between the key players that influence events. In the case of the airspace management during Operation Allied Force this was crucial. No individual can be singled out because the entire team was crucial to the success of Operation Allied Force. The team included individuals within the ICAO office in Paris, the EUROCONTROL Flow Management division including IATA, NATO NATMC staff, the International Military Staff, SHAPE, AIRSOUTH, and the CAOC. The team would not be complete without the involvement of the civil aviation representatives

from the nations in the overall AOR. It was from this team that the lessons learned for ATM have emerged and are being addressed by all concerned.

As a rule, the involvement of the NATO International Staff should include reacting to requests from the IMS for assistance at the policy level on matters relating to ATM issues. The more tactical day-to-day ATM issues should be conducted at the IMS/SC level with EUROCONTROL/CFMU/CEU. To facilitate this tactical coordination, the necessary task relationships must be defined between the staffs involved. Appropriate communications need to be established between NATO and EUROCONTROL, taking all security implications into account. It is a fact, however, that until Operation Allied Force the Alliance has, generally, left ATM as a national responsibility, at least from the military perspective.

Operation Allied Force demonstrated that the necessary command and control relationships, together with the appropriate communications, are vital to the effectiveness of civil-military ATM coordination. Failure to recognize this requirement will inevitably cause confusion and could well compromise flight safety for both military and civil operations, or impact on the efficient prosecution of military operations in the future.

Experience has also highlighted the need for close civil-military coordination during the de-escalation phase of a military conflict and the normalization of airspace management arrangements. There were many requests at the end of the operation from nations and the civil aviation community regarding the status of airspace. The necessarily imprecise wording in international agreements and protocols at the conclusion of operations such as Operation Allied Force does little to aid the normalization of the ATM situation. Ongoing military operations, the pressure from the civil aviation community to resume employment of previously established air route structures, and the extreme pressure of nations within southeastern Europe to resume revenue earning civil overflights created conflicting priorities and frequent heated debate.

Lessons Learned for Air Traffic Management

In the aftermath of Operation Allied Force, NATO conducted a comprehensive lessons-learned study to identify those changes in doctrine and new procedures required to conduct the next operation.

The impact of military operations such as Operation Allied Force on the civil aviation environment was highlighted during the studies for the first time and received acknowledgement that it was an extremely important issue. The importance of involving the civil aviation organizations at an early stage, with the obvious security caveats, is considered vital to preserving operational freedom and flight safety for all participants.

There has to be a set of procedures that establishes the framework of how to conduct an operation of this kind, but those procedures cannot cover all eventualities. Nevertheless, the NATMC presented a set of recommendations to the North Atlantic Council in the chairman's report of 2000 and they were accepted. These actions should now have been adopted and incorporated into NATO and NATMC procedures.

Briefly, the components of the ATM lessons learned resulted in a contingency checklist to guide air operation planners during and after a period of crisis together with an illustrative set of recommendations for implementing ATM crisis cells. They highlight the requirement to involve the EUROCONTROL CFMU at the outset of the airspace management planning phase. Additionally, they also identify a need to select military ATM experts to be deployed at the earliest opportunity to augment liaison teams in affected nations.

It has to be hoped that there is never again the need to mount another operation such as Operation Allied Force. However, there has to be a fundamental understanding that Air Traffic Management is a civil-military issue and, certainly in the greater European geographic area, will remain so for the foreseeable future. Acknowledging the sovereign rights that individual nations have over their airspace, the overall management of the route structure and the major civil traffic flows now lies with international institutions including NATO.

From a long-term system perspective, developments are under way within the EUROCONTROL European Air Traffic Management Program and NATO's Air Command and Control System that are designed to ensure that the necessary interoperability is established and maintained. As these operational and technical enablers are gradually fielded to support their own, differently defined command and control environments, their interactions will become increasingly crucial during periods of tension and crisis. This will enable civil-military systems

coordination to be effective instead of the ad hoc arrangements that were used in Operation Allied Force.

The relationships that have been built up over the last few years within the civil and military ATM communities and subsequently reinforced by the experiences of Operation Allied Force should ensure that we continue to operate a safe and accident-free air environment throughout Europe.

CHAPTER VIII

The Forgotten Echelon: NATO Headquarters Intelligence During the Kosovo Crisis¹

Patrick Duecy

This chapter focuses on intelligence at NATO Headquarters, before and during the Kosovo crisis. As the chapter title implies, NATO Headquarters intelligence was, and in many ways remains, the forgotten echelon of NATO's intelligence structure.

NATO is somewhat of an abstract construct, generally conjuring images of a military force. In reality, NATO is a political and military alliance with precisely defined structures and echelons each with specific authorities and responsibilities. Before focusing on crisis intelligence functions in Brussels, it is important to briefly describe what NATO is, where it is, how it works, and its intelligence functions.

The Fundamentals of NATO

NATO is not a coalition and it is not a supra-national organization. It is an alliance established by treaty for the collective defense of its member nations. By treaty, NATO member nations are pledged to the principle that an attack on one of its members is an attack on all. This requires NATO member nations to rally to the collective defense.

Among its provisions, NATO's founding treaty established the North Atlantic Council, the highest political body of the Alliance. All member nations are represented in the Council on an equal basis. The Council is the ultimate forum for political consultation and decisionmaking concerning collective defense and other matters of common interest. The Council is given the authority to create subsidiary bodies and virtually all NATO Headquarters structure flows from this treaty provision.

The founding treaty also made provisions for the Council to create a Military Committee composed of national military representatives of the member nations. Among the Military Committee's various functions are formulating NATO Military Strategy, ensuring that command structures are in line with NATO strategy and, most importantly, providing military advice to the North Atlantic Council. Both the Council and the Military Committee, and virtually all other NATO Headquarters bodies and subsidiary groups, operate and take all decisions on the basis of consensus. Exceptions are the Strategic Commands.

NATO Headquarters Organizational Structure and Authorities

NATO's most important echelons and their interrelated structures are shown in Figure 1. The Alliance's highest political authority is the North Atlantic Council. It is the principal body described in the Washington Treaty. Almost all other NATO authorities and structures are creations of the Council. The Council itself is composed of representatives of the member nations. Day-to-day national representation is vested in ambassadorial level permanent representatives, but Council meetings are convened at the levels of Foreign Ministers, Defense Ministers, and Heads of State when appropriate. Presiding over the Council is the NATO Secretary General who is appointed by the nations. The Secretary General speaks and acts for NATO within the guidance and authorities extended by Council. An International Staff of civilian personnel, organized as shown in Figure 2, supports the Council.

NATO HEADQUARTERS PRINCIPAL BODIES

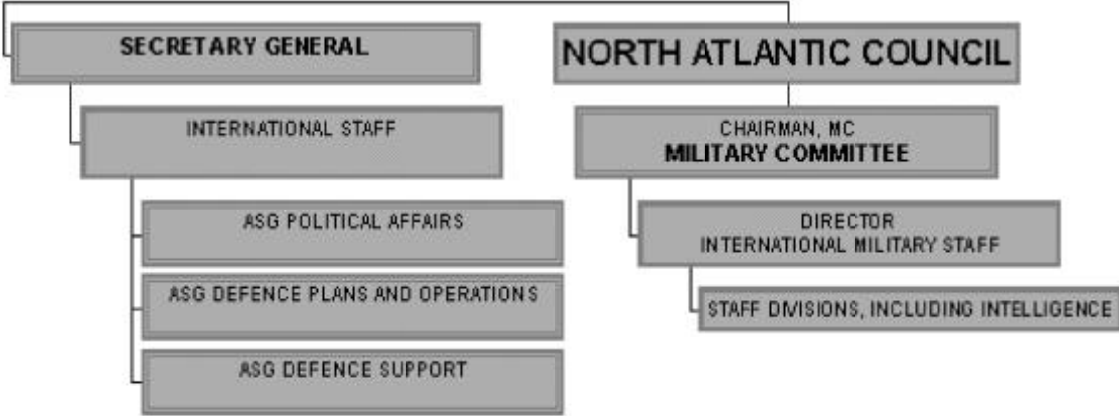
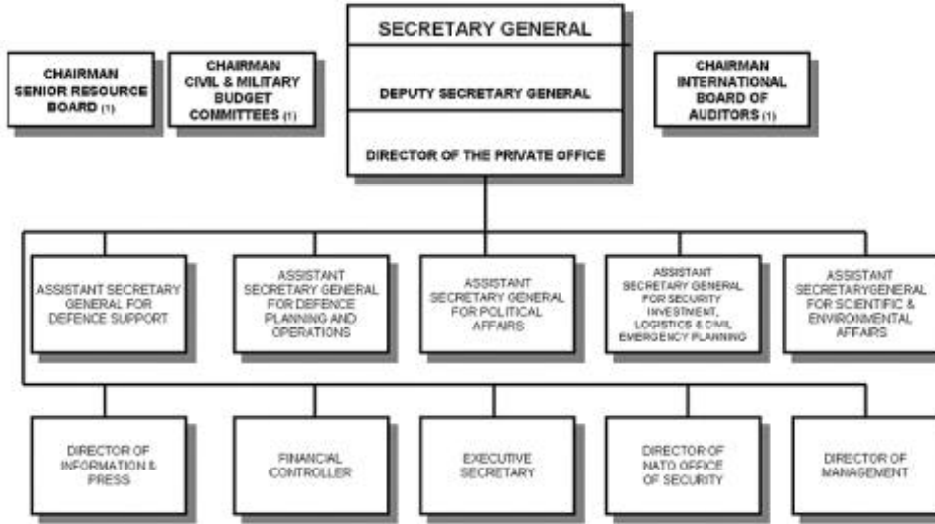

Figure 1. NATO Headquarters Principal Bodies

The NATO International Staff



(1) These positions are not filled by members of the International Staff but by national chairmen appointed by the Council.

Figure 2. The NATO International Staff

NATO's senior military echelon is the Military Committee. Like the Council, the Military Committee is composed of national three star flag and general officer representatives meeting in permanent session. The Military Committee routinely provides military advice to the North Atlantic Council and conveys Council guidance and decisions on military matters to NATO's Strategic Commanders, SACEUR, and SACLANC. The Military Committee periodically meets at Chiefs of Defense Staff level. The Military Committee Chairman is a four star officer appointed by the nations. He represents the Military Committee in Council meetings and speaks and acts for the Committee within the guidelines and authorities extended to him. The international military staffs support the Military Committee, which includes the Intelligence Division as shown in Figure 3. Neither the Secretary General nor the Chairman Military Committee have executive powers, but speak and act for NATO on the basis of consensus in their respective bodies.

The International Military Staff

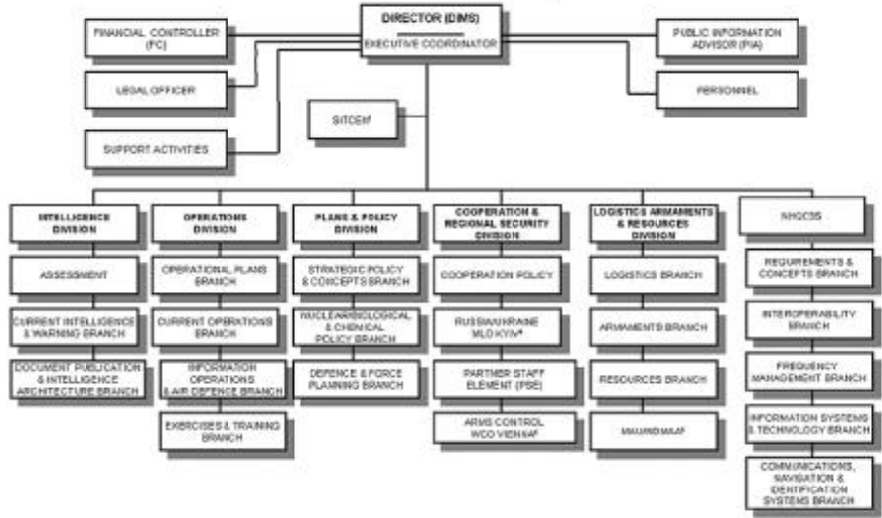

(1) The Situation Centre (SITCER) reports to the Assistant Secretary General for Defence Planning & Operations but is directed on a day-to-day basis by the Director of the International Military Staff.
 (2) The Information Systems and Technology Branch serves both the International Staff and International Military Staff.
 (3) The NATO Headquarters Consultation, Command and Control (C3) Staff is managed jointly by the Director (DIMS) and the Assistant Secretary General for Defence Support.
 (4) MLO: Military Liaison Office.
 (5) WCO: Weapons Consultation Office.
 (6) Management Advisory Unit/NATO Defence Manpower Authority.

Figure 3. The International Military Staff

The Council's decisions, based on Military Committee advice, are conveyed to NATO's Strategic Commanders—Supreme Allied Commander Europe (SACEUR) and Supreme Allied Commander Atlantic (SACLANT)—normally through the Military Committee or on certain occasions, the Secretary General on Council's behalf. The Strategic Commanders are responsible for operational planning, assembling, and structuring forces and executing operations authorized and directed by the Council.

SACEUR exercises his command authority over Allied Command Europe through Supreme Headquarters Allied Powers Europe (SHAPE) located in Casteau, Belgium. SACLANT is located in Norfolk, Virginia, and is supported by a headquarters for Allied Command Atlantic. Both SACEUR and SACLANT have various subordinate commands.

NATO Strategy

In the immediate post-Cold War period, NATO articulated a new strategy which advocates a broad politico-military approach to security. Its key objectives are maintaining stability, fostering the adoption of NATO's common values, and managing crises that threaten stability and peace in Europe and adversely impact NATO interests. The strategy calls for NATO's active engagement in cooperation and dialogue with non-NATO nations, including Russia, Ukraine, and other former members of the Warsaw Pact and former republics of the Soviet Union.

NATO, as part of its stability enhancing strategy, offered these former adversary nations membership in a cooperative association with NATO in pursuit of common objectives of peace and stability. This association is known collectively as the Partnership for Peace, and is an important feature of NATO's strategy and day-to-day political-military operations. Both Russia and Ukraine have unique relationships with NATO through separate agreements. New forums were established to facilitate dialogue and consultation with Partner nations, Russia, and Ukraine. The overarching body for NATO and Partner nation meetings is the Euro-Atlantic Partnership Council (EAPC). The EAPC and separate forums for Russia and the Ukraine take place in at both political and military levels.

NATO documents, including the NATO Strategic Concept and details of the organization may be accessed through Internet site <http://www.nato.int/>

Intelligence at NATO Headquarters

Organization: A single staff drawing upon the intelligence contributions of the NATO nations and NATO commands provides Intelligence support of NATO Headquarters. Because intelligence is a function of military command within NATO, the Headquarters' intelligence staff is integrated in the International Military Staff subordinate to the Military Committee (see Figure 3).

Mission: Although it is a military staff, the International Military Staff's Intelligence Division has a mission of supporting the requirements of the Secretary General, the Council, and all Headquarters' staffs and committees, whether military or political.

Intelligence Functions: In general, the intelligence staff performs the generic functions common to all intelligence staffs. Intelligence functions include strategic indications and warning, situation reporting (current intelligence), strategic estimates, managing intelligence requirements, intelligence reporting, and dissemination. In recent years the intelligence staff has expanded its support to take account of NATO's strategic dialogue with Partnership for Peace nations and its interaction and cooperation in crisis management operations with non-NATO nations in coalition with the Alliance. This has been done without resource augmentation.

Indications and Warning: NATO manages the military indications and warning function interfaces with the nations and contributes its own analysis to maintaining a warning status. NATO warning is both strategic (long-range estimates) and, in recent years, includes instability warning and warning of imminent threats to Alliance personnel and facilities, normally from terrorist groups. The warning function is federated among the nations, the IMS Intelligence Division, the NATO Office of Security, which manages NATO Counter Intelligence, threat warning, and the NATO Commands.

Collection and Requirements Management: NATO has no intelligence collection resources of its own. It relies entirely on the nations for contributions of intelligence for NATO's common use. NATO intelligence authorities can request intelligence from the nations, but the nations are not obligated to provide it. During recent years, some nations have transferred operational and tactical authority for the direction of some of their intelligence collection resources to NATO field commanders. This however, is not doctrine nor are NATO nations

obligated to declare intelligence collection resources to NATO. A legacy of NATO's reliance on nations for intelligence is a lack of staffs trained and equipped to manage complex, multidiscipline intelligence collection operations. In reality, NATO staffs and Commands are end users of finished intelligence products provided by the nations and NATO's operationally deployed commands.

Management of the NATO Intelligence Production Program: This is a key function through which NATO nations participate in a cooperative production program to provide the Alliance with strategic estimates and other basic intelligence documents on aspects of military capabilities and risks. Most production under this program is NATO agreed intelligence, which means the formal agreement among all nations to the content of products with subsequent approval by the Military Committees.

Special Intelligence: NATO nations contribute special intelligence to the Alliance to complement other reporting. The Special Intelligence function is an adjunct to the normal collateral source contribution of the nations and requires extraordinary handling and dissemination procedures.

Partner Dialogue and Consultation: As noted, the Intelligence Division has new tasks in providing a basis in intelligence for dialogue and consultation between NATO and the Partner nations.

Intelligence Staff: The staff is multinational with an average strength of 25 military and civilian personnel. Some members of the staff are intelligence professionals, but most are posted to the staff with no prior intelligence experience. Staff tasks include the production of intelligence reports, briefings and assessments, the management of the NATO intelligence production program (performed in coordination with the NATO Nations), management of information systems, maintenance of an intelligence registry and management, reporting, and dissemination of NATO Special Intelligence.

Intelligence Information Architecture: Dissemination, handling and management of intelligence information is now almost exclusively conducted through secure digital information systems interconnected with other headquarters staff elements through a local area network. External intelligence connectivity with NATO commands and national capitals is through an interoperable system of systems, all of which are secure and offer basic electronic mail and Web services. These NATO

wide area networks extend from the strategic to the tactical echelons. Intelligence core data and exchange transactions with the nations and commands are protected from general NATO access by firewalls. During the Kosovo crisis most mainline intelligence information communications connections were limited to a 64kbps capacity. The basic software standard is commercially available Microsoft applications. Owing to NATO and national security boundaries, there are no direct, digital connections between NATO communications and intelligence information systems and those of the nations.

NATO Headquarters Intelligence and Kosovo Crisis Operations

NATO's first operational combat engagement was in Bosnia, but with the exception of limited combat air operations, deployment and subsequent operations were predominantly permissive in nature. Kosovo was a full spectrum test of NATO's capabilities and strategy beginning with instability evolving to a crisis with an intensive preventive diplomacy overlay, followed by a major air intervention and deployment of a stability and security restoration ground force.

As in the Gulf War, the strategic, operational, and tactical military capabilities and technological art demonstrated by the United States component of NATO's forces during Kosovo was a shock to European NATO. Much was experienced, but it remains to be seen how much was learned. At this writing it is clear that the Kosovo experience compelled Europe to at least demonstrate a unified political intent to remedy the many strategic capabilities shortfalls made evident during Kosovo crisis management and combat operations. It is not yet clear whether political intent will be translated into meaningful investment and restructuring to advance Europe's military capabilities, including national or collective strategic intelligence capacities.

NATO's institutional intelligence functions—that is, all the capacities to manage, produce and report intelligence within the framework of the NATO institutional military structure—were also tested. Kosovo revealed a number of important findings:

First, NATO command and staff intelligence has not kept pace with advances in communications, computing technology, information management or strategic and operational intelligence art.

NATO intelligence functions and capabilities have not sufficiently adapted to effectively support the politico-military strategy first articulated by NATO in 1991 and refined in 1999.

Improvements in NATO intelligence capabilities, such as they are, have been driven by operational necessity, not by programmed investment in response to NATO guidance and statements of required intelligence capabilities.

To illustrate the impact of these shortfalls on strategic intelligence in the Brussels politico-military headquarters, a brief synopsis of the intelligence challenges encountered is provided in succeeding paragraphs. NATO's intelligence lessons learned are provided in the chronological order in which they emerged, that is, during the phases of instability, crisis, conflict, and peace support operations. The reader should keep in mind that the following narrative is strictly from the perspective of NATO Headquarters, Brussels and does not take into account broader intelligence implications for the Alliance's commands or forces which planned and executed Operation Allied Force.

Emerging Instability: Kosovo was on NATO's Balkans agenda well before the crisis of 1998-1999. But, its visibility as a potential crisis area was well below the Alliance's concern threshold until nearly the end of 1997. Other issues were dominating the Alliance's time and energy when the Kosovo stability equation began to change late that year. Even though the Kosovo Liberation Army (KLA) had announced itself some two years earlier, November 1997 marked the beginning of a visibly activist KLA program characterized by a series of small armed attacks on Serbian police and civil officials in Kosovo. Those early incidents were recognized for their potential to generate broader problems and were reported in Headquarters intelligence briefings and assessments.

Initial NATO Intelligence Challenges: In the fall of 1997 little about the KLA was known or discoverable. Likewise, NATO's knowledge of the dispositions and strengths of the Federal Republic of Yugoslavia (FRY) military and its other security forces in Kosovo, particularly the various categories of Serbian Interior Ministry police or MUP, was also slim.

Recognizing An Emerging Crisis: In keeping with experience in Bosnia Herzegovina and Serbia's past record of repression in Kosovo, there was an expectation that Serbian security forces would react to KLA provocations forcefully and, by internationally accepted norms,

disproportionately. An escalation of tensions and a destabilizing spiral to communal violence was a central scenario that NATO headquarters staff intelligence officers began to stress in their reporting and analysis.

Establishing an Intelligence Foundation: In the early days of escalating tensions and incidents, the first priority of NATO Headquarters intelligence staff, aside from situation reporting, was to build a base of data to draw upon to form a context for unfolding events and developments. The sketchy results of NATO's requests to the nations for gap filling intelligence data suggested that the nations too were operating from a slim intelligence information foundation on Kosovo. This marked the first signs that the doctrine of NATO depending on its member nations for all of its strategic intelligence needs would eventually prove unsound. For example, the NATO baseline for FRY order of battle and military facilities in Kosovo for example, was initially derived from Yugoslav CFE declaration data through the initiative of an enterprising SHAPE intelligence officer. However, data on the most important Serbian security instrument in Kosovo, the MUP, was singularly lacking in scope and detail. Despite their central and notorious role in Bosnia, even less was known about the unofficial instruments of the Belgrade regime, the *paramilitaries*.

Providing a Strategic Intelligence Baseline for Decisionmaking: Given the potential for Kosovo's destabilization to internal conflict and the implications for the region, the NATO intelligence Director initiated a request for the production of an intelligence estimate on Kosovo to serve as a policy and strategic decision baseline for NATO's senior political and military authorities. In keeping with NATO's consensus business practices, such intelligence estimates must be NATO agreed if they are to be accepted as authoritative. NATO agreed means an intelligence product that has the full concurrence of all nations and the approval of the Military Committee. In this instance, a draft was quickly produced that was substantively agreed to by all national Balkans experts.

National senior intelligence approval authorities in capitals however, could not reach consensus and the estimate was not published. This was the only time NATO attempted to produce an agreed intelligence estimate on Kosovo as a formal basis for Alliance planning and decisionmaking. All other intelligence concerning Kosovo was staff intelligence. Staff intelligence is produced by NATO's own institutional intelligence staffs based on the intelligence contributed to them by the nations and NATO commands. Staff intelligence is used for day-to-day

NATO deliberations and decisionmaking, but does not carry the weight and authority of a NATO agreed product.

Strategic Warning of Crisis and Conflict: In December 1997, NATO Headquarters Intelligence, based on national contributions and its own subsequent assessments and analyses of the developing situation, issued a formal intelligence warning to all nations and NATO commands that Kosovo was evolving from crisis toward conflict. NATO's warning pre-dated all other warning by any individual nation. At the time, the NATO warning was disputed and rebutted by several NATO nations.

The Beginning of Crisis and Conflict: In February 1998, Serbian security forces undertook an anti-KLA operation against the prominent Kosovar Albanian Jashari clan. The Serbs' disproportionate use of force was widely reported by the press. This incident ignited Kosovar Albanian popular sentiment filling the ranks of the KLA. It was in many ways the point of no return for the Serbs, Kosovar Albanians, the KLA and NATO. In gauging the impact and portent of these developments, NATO intelligence was heavily dependent on open source information, principally the media in and around Kosovo and on the conflicting claims of the antagonists. This was to remain the case throughout the spring and summer of 1998.

NATO Intelligence Challenges, Summer of 1998: Because Kosovo was a denied access area for NATO, monitoring and assessing the developing situation in Kosovo depended heavily on open source media and strategic collection resources. Although strategic collection resources were employed, they did not prove particularly well suited to monitoring and reporting the ebb and flow of small armed actions by paramilitary groups, special police, and KLA forces. Major challenges during this period included assessing the severity of fighting, the methods, strengths and dispositions of FRY main forces, Serbian Special Police and the KLA, the effects of the intensifying fighting on the civilian population, and gauging the KLA's support and resupply infrastructure.

Humanitarian Dimensions of the Crisis: Growing numbers of refugees and internally displaced persons became a matter of great concern as the winter of 1999 approached. NATO reliance on national intelligence contributions did not prove adequate to form an accurate appreciation. Technical intelligence collection proved only marginally productive in quantifying the humanitarian dimensions of the crisis. This was not a surprise, but a known shortfall learned from similar attempts to monitor

displaced persons in Rwanda using otherwise highly capable tactical airborne imagery collectors.

Assessing the Fighting: Strategic technical collection continued to prove inadequate for monitoring and assessing the dispositions, deployments, and operations of the opposing forces. The principle impediment, as discovered earlier in Bosnia Herzegovina, was the unsuitability of strategic sensors for searching out, identifying, and tracking the small armed units employed by both sides. Some overt multinational human intelligence was extremely valuable during this period, but too limited in volume and scope to enable NATO to form a comprehensive, dynamic picture.

Assessing Strategy and Intentions: Reporting from nations and commands concentrated for the most part on the military aspects of events in Kosovo, not on assessing intentions, strategies, or future prospects. As a consequence, NATO's insight into Kosovo internal groups, events and developments, and those in the FRY at large, particularly in Belgrade during this period, was extremely limited. The lack of politico-military assessments and short-term forecasts from the nations was a shortfall throughout the evolution of the crisis to active conflict when NATO forces were committed. As a consequence, NATO Headquarters intelligence produced its own assessments and near term forecasts throughout the crisis and conflict.

Finally, it was also clear during this period that the KLA, surprised by the large influx of volunteers to its then thin ranks, was desperately seeking arms, supplies, and the means to organize and train its new forces. NATO Headquarters staff, with good input from many nations, undertook an in-depth study of KLA financial networks and arms procurement and trafficking methods. A credible result was achieved, but efforts to implement practical countermeasures proved not within the NATO nations' capacity to organize and execute.

Intelligence Challenges During Late 1998—early 1999: With the approach of winter in 1998, international community concerns with the humanitarian consequences of large numbers of persons displaced in the Kosovo countryside became acute. Belgrade, pressured with the threat of NATO punitive air strikes, acceded to a cease-fire, a partial force withdrawal from Kosovo, a NATO air surveillance regime and the deployment of an OSCE monitoring mission. The cease-fire was also nominally agreed to by the KLA.

The OSCE Contribution to Crisis Management: Once the OSCE's Kosovo Verification Mission (KVM) was in place, the OSCE began routinely reporting on compliance of the parties with the cease-fire and the provisions of implementing U.N. Security Council Resolutions. OSCE compliance observations provided first hand insights to the situation and were a marked improvement over media and sketchy human intelligence source perspectives. Although intense diplomatic efforts to reverse the course of the crisis were ongoing at the turn of the New Year (1999), the picture emerging from Kosovo was uniformly discouraging in terms of prospects for a peaceful settlement.

In the beginning, FRY Federal and Serbian Republic forces were largely in compliance, but increasingly sensitive to the KLA's expansion into areas vacated by VJ and MUP forces. Early in 1999, the situation, as reflected in OSCE observations and media, was one in which the KLA had established a presence on much of the key terrain and along lines of communications in the province and were challenging the MUP.

At the same time, Belgrade's forces were not blameless in contributing to the deteriorating ceasefire and force withdrawal agreement. In late December and early January, they began a series of sorties from garrisons under the guise of spring military training, conducting provocative live fire exercises. The Special Police in the meantime were continually rotating personnel in and out of the province on the basis of resting their forces. This was in part a cover for the introduction of larger numbers of MUP, some of which were specialized in counterinsurgency and counter-terror operations. FRY military training grew in intensity in conjunction with MUP elements near key areas of KLA concentrations measurably increasing tensions and exchanges of fire. NATO intelligence concluded that both sides were fully committed to resumption of fighting in the spring of 1999, and that the Serbs were conducting reconnaissance and probes to shape and fix KLA forces.

The major intelligence challenges and tasks during this period included:

- Credible compliance reporting to NATO authorities;
- Crafting reports to the United Nations on behalf of the NATO Secretary General;

- Providing the KVM with intelligence support for the protection and safety of the mission; and
- Maintaining an appreciation of trends and events on the ground and forming a strategic assessment of the intentions of Belgrade and the KLA.

Compliance Reporting: NATO compliance reporting was almost exclusively based on the OSCE KVM monitoring supplemented by NATO intelligence data. OSCE, operating under extremely difficult conditions, provided a steady stream of extremely helpful monitoring reports, although KVM monitors were rarely able to directly observe a compliance or cease-fire violation. KVM was most often on the scene after a violation was reported by one of the parties and therefore became hostage to the conflicting claims of the adversaries. NATO intelligence staff, in coordination with SHAPE intelligence staff, compared the KVM reporting with other available information and produced composite, evaluated compliance assessments for NATO political and military authorities. Periodic NATO reports to the United Nations drew directly from the NATO body of compliance reporting although in some cases the lack of a U.N. information security regime complicated and impeded transparency. This was the case when NATO intelligence sources formed portions of compliance assessments, precluding some information being shared with the United Nations.

Force Protection Support of the KVM: The lack of information security arrangements between NATO and non-NATO organizations were to prove a recurring and intractable problem throughout the Kosovo crisis.

It first became a major issue when the OSCE took to the field in Kosovo. OSCE's fully transparent information doctrine, like the United Nations's, meant there were no provisions for OSCE protecting any classified information NATO might otherwise be willing to release. Therefore, in the absence of a security agreement between NATO and OSCE, sharing classified information between NATO and the OSCE's Vienna staff, the KVM staff in Pristina, and with KVM field observers was not possible. The most serious aspect of this procedural and legal shortfall was NATO's inability to provide classified information directly to the KVM to enhance the safety and protection of KVM personnel. The solution was a NATO request to individual NATO nations to provide force protection intelligence directly to the KVM on a bilateral basis. This produced some results in that relevant information was conveyed

directly to certain NATO member nations' personnel within the KVM mission. This enabled some KVM headquarters personnel to make informed choices in directing security measures and operational plans for the KVM mission overall. Complicating the effectiveness of KVM security and protection measures further, the only secure communications with KVM Headquarters was through a secure telephone and facsimile in Pristina under the control of nation staff members from NATO nations.

Strategic assessment of the intentions of Belgrade and the KLA: Crafting dynamic NATO assessments of events and trends on the ground in Kosovo remained problematic during the KVM mission, but discerning the intentions of Belgrade and the KLA proved even more difficult. NATO nation reporting provided few insights on developments in Kosovo beyond those offered through the KVM. NATO Headquarters intelligence was left largely to its own devices to assess Belgrade's and the KLA's intentions from a political and military perspective. NATO nations provided current military intelligence reports to the headquarters, but very little in the way of integrated, strategic politico-military assessments. In this respect, NATO's senior politico-military echelon was singularly reliant on its own staff resources for strategic assessment and forecasting.

A key aspect of the NATO Strategic Concept specifically underscores the role of preventive diplomacy in defusing crises and finding political solutions. During the entire period of intense diplomatic efforts to resolve the Kosovo crisis, NATO as an institution, certainly at the staff level, had very little insight to the dynamics of negotiations or prospects for a political solution. NATO had no institutional representation at the Rambouillet conference and at the NATO staff level, insights to the progress at Rambouillet were obtained only through individual NATO nations involved in the meetings. No national contributions of intelligence to the Alliance included any details of preventive diplomatic activity. This was a serious intelligence gap in NATO's politico-military strategic level to fully assess prospects for peace or conflict. In this respect, NATO Headquarters intelligence was not only a forgotten echelon, but an isolated echelon.

NATO Intelligence Challenges, Winter and Spring of 1999: Although extremely valuable in observing and monitoring, it was evident that the KVM was increasingly a bystander in the face of the determination of the adversaries to pursue their strategies in Kosovo. Fighting continued

to escalate with incidents initiated and provoked by both sides. The killings of Kosovar Albanians at Racak and the KVM's judgement that the Serbian special police were responsible was a watershed after which Belgrade clearly considered the KVM as hostile to its interests. Serbian harassment and threatening behavior toward KVM monitors increased but remained short of outright violence. Meanwhile, intense diplomatic efforts continued at the Rambouillet Conference in an attempt to find a political solution to the building crisis. The FRY and NATO were steadily progressing from crisis to confrontation and conflict.

Intelligence, Spring—Summer 1999: The KVM withdrew from Kosovo quickly and without incident on 20 March. Coordinated FRY offensive operations against KLA strongholds began immediately with special police in the vanguard and the VJ, for the most part, in a security and supporting role. Paramilitary forces were also at work in the province. Despite senior VJ and special police predictions that the KLA would be swept from Kosovo in a matter of a few short weeks, this proved not to be the case. On 23 March 1999 the NATO order was given to commence NATO Operation Allied Force.

NATO Headquarters Intelligence Challenges During Operation Allied Force: The principal staff intelligence focus during the course of Operation Allied Force was strategic situation reporting to NATO's senior political and military authorities in the Headquarters Brussels. However, a variety of other functions were also performed.

Situation Reporting: Keeping NATO seniors and staffs informed of events, trends, and expected developments was the IMS Intelligence Division's primary task. As Operation Allied Force began, the tempo of Headquarters military and political consultation had already reached a high level, but again increased by an order of magnitude.

With the initiation of the air campaign the Council met once per day, everyday. The Military Committee endeavored to do the same. In addition to preparing separate daily situation briefings for Council and the Military Committee, a combined operations and intelligence situation report was produced twice daily (beginning and end of day) providing amplifying details of current issues and developments not covered in situation briefings. Other intelligence requirements included information and current situation briefs for Partner nations and separate briefings for Partner nations immediately bordering the conflict zone.

Council Situation Reporting: Approximately 10 minutes of combined, highly aggregated intelligence and operations information, were personally delivered by the Chairman of the Military Committee as a narrative without graphics aids, as is the usual practice in NATO Headquarters. In addition to coverage of key developments, the intelligence portion included a short outlook on expected trends and potential developments in both political and military sectors. The Council was intensely interested in air campaign trends, force protection and indicators of Belgrade's bending to the pressure of the air campaign. Collateral damage and civilian casualties were critical interests owing to the potential political impacts. As large numbers of Kosovar Albanians began pouring into Albania and the Former Yugoslav Republic of Macedonia, the stability of those nations became a key political issue. Displaced persons inside Kosovo also drove efforts to quantify, locate, and describe the conditions of displaced persons.

Military Committee Situation Reporting: Reporting to the Military Committee was in the form of briefings. Intelligence and operations presentations were separate, each usually about 10 minutes in duration, with accompanying graphics. Briefings concentrated on the impact of the air intervention on strategic targets in Kosovo, the FRY and Montenegro, the effects of tactical strikes in Kosovo, the status of air defenses, dispositions and aspects of the adversaries' operations in Kosovo and the VJ in FRY at large and, as the campaign wore on, the status of displaced persons and refugees. Battle Damage Assessment, including progress toward isolating FRY forces in Kosovo, was among the high interest issues.

Strategic Assessment Tasks: Assessing the totality of political, military, and economic aspects and impacts of the conflict presented NATO Headquarters intelligence staff with tasks not previously envisioned.

Military Assessment: Assessment of military aspects of the NATO intervention was bounded by the classic challenges encountered in any military campaign; measuring the residual capacities of the enemy to conduct defensive and offensive operations, gauging intentions, estimating adversary sustainment and logistics and other well known factors. Owing to the nature of the NATO intervention, the status and residual capabilities of FRY air defense was of key importance. In the case of Kosovo itself, NATO was keenly attuned to assessments of the ebb and flow of fighting between FRY and KLA forces and the effects on

the civilian population and infrastructure of the province. Assessment was also complicated by FRY information denial and deception and the vagaries of weather, impediments to intelligence collection access and the national limits on the intelligence reporting made available to NATO. Overall, the Headquarters intelligence staff's military assessment tasks, although by no means easy, were relatively straightforward. In the main, they were accomplished in a manner commensurate with needs at the strategic echelon, although a higher level of resolution would have been welcome by political and military authorities.

Political Assessment: Political assessment was the critical factor in NATO senior authorities' calculus of the trends in the intervention, in that the military operation was a means to a political end, not an end in itself. During peacetime operations, political analysis, assessment, and reporting in NATO Headquarters are the domain of the International Staff. Military Intelligence is expected, and reminded from time to time, to remain centered on military and related security factors. During Operation Allied Force two factors combined to severely challenge the intelligence staff's capacity. First, nations did not contribute strategic political reporting or assessments to NATO. Second, the International Staff evidently became so burdened with managing NATO's own political tasks, that it could not provide political situation reports or assessments in support of the Alliance's senior political body. The International Military Staff Intelligence staff quickly filled this strategic intelligence vacuum to the best of its abilities relying on its own resources for gathering and analyzing political factors and intentions. Virtually every International Military Staff intelligence situation report to Council and the Military Committee contained some assessment of political factors bearing on the conflict. It was later revealed that there was a great deal of sub-rosa politico-diplomatic activity into which NATO intelligence did not have adequate insight to evaluate and factor into its assessments. In a conflict uniquely characterized by application military power to force a favorable political outcome, the lack of sophisticated political assessment was a singular shortfall.

Economic Assessment: The shortfall in political assessment was compounded by lack of insight into the complex economic factors impacting Operation Allied Force and NATO's strategy. Again, the lack of nations' reporting to NATO and an initial lack of appreciation of economic factors, in general, was a challenge for the Headquarters' intelligence staff. It soon became important to have basic information

and understanding of FRY electrical power capacities, petroleum supplies and sources, military POL storage (strategic and tactical), the politico-economic vulnerabilities of the Milosevic regime and the impacts of the conflict on regional markets and economies. Even the legal aspects of energy commerce with the FRY came to thwart efforts to impose what was intended to be a strict energy blockade near the end of the conflict. As a military Alliance, not yet adapted to the Post Cold War nature of complex political-military conflicts, NATO was not well prepared for the politico-economic dimension of new era conflict. NATO intelligence was reactive in its consideration of economic factors throughout the conflict.

Integrated Military, Political, and Economic Assessment: While most capable in performing military assessments, it is evident that NATO intelligence was far less capable in political and economic sectors. As noted, the intelligence staff moved into previously out-of-bounds political and economic areas, but it was largely a reactive, patch-and-paste effort. These new challenges, combined with the high tempo of politico-military consultations and military operations, left little capacity to perform a full range of military, political, and economic analysis and indepth assessment. More importantly, the skills, subject expertise, and staff depth to integrate these analytical disciplines into a seamless whole was not sufficient. This is a significant shortfall, which is now being examined with nations and within the NATO staff.

Informing NATO Partner Nations and Front-Line States: Briefings to partner nations, and especially the front-line states bordering the conflict zone, became a key component of NATO's consensus building and crisis containment efforts. The front line states were of immediate and critical importance owing to NATO's needs for airspace access, overland transport, staging areas for the ACE Rapid Reaction Corps (ARRC) and for various aviation and logistics operations. The mission of informing partners was an especially difficult task for intelligence owing to the lack of national intelligence contributions releasable to them. The solution was the use of open source material validated by what was known in intelligence channels. Although not directly drawing on intelligence sources, the briefings were accurate and timely reflections of the situation.

NATO Public Media Campaign: One of NATO's most critical strategic political challenges was coping with the skillful information campaign mounted by Belgrade. NATO information and press officers were

confronted with the need for extremely current, accurate, command-validated military information. This was especially the case when rebutting Belgrade's various false claims of collateral damage, civilian casualties, and NATO aircraft losses. NATO intelligence and the Headquarters bureaucracy did not have sufficient mechanisms to quickly sanitize and release intelligence data for use in daily public media briefs. Only SACEUR, taking advantage of his authorities as U.S. European Commander (USCINCEUR), had the mechanisms to produce daily military operations updates based on sanitized operational and intelligence reporting. NATO headquarters intelligence requests to the nations during the course of the air campaign for sanitized data to support the NATO media effort produced little response. This included the NATO nations presenting detailed daily media briefings in their own national capitals. Understanding and providing for the media campaign needs of NATO headquarters during the air campaign was a key shortfall, although the NATO press and information officer bridged NATO's initial vulnerability with great skill and personal forcefulness. Ultimately, key nations provided expert support and inputs to improve and add depth to the NATO public media campaign. The limitations on intelligence contributions are recognized and are high among the post-conflict priorities for remedial work.

Information Operations: NATO Headquarters intelligence had no role in information operations in the context of more esoteric and high technology forms. The closest NATO intelligence came to involvement in information operations were its attempts to support the Alliance's public media campaign. As noted, NATO intelligence could not respond adequately in the form of publicly releasable intelligence facts, figures or data to help counter Belgrade's aggressive media campaign. NATO intelligence is no more and no less than what the nations provide for NATO to use. Sanitizing contributed intelligence and releasing it for public dissemination is within the authority of NATO, but the coordination mechanisms and staffing requirements satisfactory for deliberate, planned Cold War requirements, were totally inadequate in the face of compressed time frames and high operational tempos during the Kosovo crisis and intervention. Information operations is one of NATO's priority areas for improvement, especially media operations. Developing NATO capabilities to perform more complex information operations missions, given the legal and political sensitivities, the technical complexities and NATO's lack of organic intelligence collection capacity, is problematic.

Release of Intelligence to NATO: Almost all NATO nations improved upon their intelligence contributions during the crisis and air intervention, but the intelligence most responsive to NATO Headquarters' needs was contributed by a very small percentage of nations. In addition, many partner nations and NATO's three newest member nations were extremely generous and helpful in sharing their regional insights and expertise with the Alliance. Overall however, the United States was by far the main contributor of intelligence relevant to the needs of Headquarters. Even U.S. intelligence tended to focus most reporting on military and operational aspects. With the exception of U.S. strategic battle damage assessments, which had both technical and some strategic politico-military-economic dimensions, U.S. intelligence contributions did not include integrated military, political, and economic assessments and forecasts. Aside from the obvious need for military intelligence reporting, which was largely met by the U.S. Defense Intelligence establishment, strategic assessment and forecasting was not a strong suit of any contributing nation. NATO headquarters benefited greatly from reporting on the military aspects of the crisis, but was essentially on its own in the key task of politico-military and politico-economic assessment and forecasting.

Requirements Management: The volume and content of intelligence flowing to NATO obviated a heavy NATO Headquarters effort in levying intelligence requirements on the nations. Although there were gaps and NATO registered requests for information, nations for the most part did not readily respond to the requirements levied, especially in the short time frames required. In any event, requirement management within NATO is not centrally managed nor does NATO yet have modern tools for managing a high volume of requirements. The NATO nations' slow or lack of responsiveness to requirements cannot yet be fully explained.

It is possible that the demands of Kosovo simply left little capacity within many national intelligence organizations to respond to NATO requirements. It is also possible that priorities in the more capable nations were directed exclusively to the execution of the military campaign. For example, among some nations' intelligence organizations, particularly the Combat Support Agencies comprising the U.S. Defense Intelligence component, the understanding of the differentiated roles of the NATO military commands and the NATO Headquarters in Brussels is not well understood. In addition, U.S. Combat Support Agencies regard warfighting support of national forces as their *raison d'être*. Therefore, it can be imagined that support of the NATO politico-

military strategic echelon in Brussels ranked at least third in priority after support of SACEUR/CINCEUR as force commander and national and NATO forces engaged in combat missions.

Open Source Exploitation: NATO intelligence had neither the staff capacity nor the expertise to rapidly assimilate, analyze, and exploit open source information. This was a key shortfall owing to the wealth of information available through media and other sources. Within staff resources, NATO Intelligence made maximum use of the Internet to monitor and incorporate open source into its products, but true NATO exploitation of open source has yet to be achieved. The most impressive contributor of open source information to the Alliance was, and remains, the Multinational Intelligence Coordination Cell (MNICC) manned by a select number of NATO nations on a bilateral basis at the U.S. European Command's Joint Analysis Center.

Headquarters Intelligence as a Function of Planning: Intelligence at NATO Headquarters only indirectly supported planning for Kosovo contingencies and operations. Detailed operational planning was performed at SHAPE in conjunction with the air, ground, and maritime component commanders. In reality, the U.S. European Command in cooperation with staffs in the continental United States performed a great deal of planning support. The intelligence contribution to planning was almost exclusively from the United States with data released to NATO for drafting of plans. Significantly, USEUCOM's Joint Analysis Center Molesworth, UK was officially designated in NATO operational plans as the NATO intelligence fusion center for Operation Allied Force. NATO Headquarters intelligence role was for the most part one of reviewing SHAPE risk assessments underpinning operational planning. Owing to the lack of depth in intelligence information available and staff expertise, NATO Headquarters intelligence reviews were at best very broad.

Some Final Observations

It is useful to keep in mind that mission functions performed satisfactorily tend to generate little comment. Conversely, less than fully satisfactory performance rightfully gets the most attention in the form of criticism and lessons learned analyses. On that basis, NATO intelligence staff, on balance, successfully performed all the tasks assigned to them and took a great deal of initiative in filling needs not

normally within their charter. In too many instances however, NATO depended on staff flexibility, adaptability, and extremely hard work as the formula for meeting unprecedented mission challenges. NATO intelligence staff was simply not trained or equipped for complex politico-military crisis management and an equally complex, high tempo military campaign with major political and economic dimensions. Therefore, the final observations and conclusions presented below are a critique of deficiencies in NATO Headquarters intelligence doctrine, structure, and its enabling infrastructure and tools. As noted, the headquarters intelligence staff bridged these shortfalls with imagination, team commitment to the mission and hard work. It is because the Alliance and its intelligence staffs need and deserve better that this chapter was written, and it is in that spirit that final observations are offered.

NATO Strategic Indications and Warning: NATO Headquarters intelligence warned of impending crisis and conflict in December 1997. There is no question that NATO intelligence strategic warning was timely. However, it is questionable whether it was effective. A key issue with warning's relevance and effectiveness is its impact on stimulating a political or military response. It is extremely difficult to measure the effectiveness of early strategic warning in terms of NATO's subsequent planning, decisionmaking, and force execution. Strategic politico-military warning is far different than warning of attack or immediate threats and is therefore much less likely to generate a prompt politico-military response that can be directly correlated to the warning given. Nevertheless, in the wake of the Kosovo experience, NATO intelligence has restructured its warning doctrine and procedures to focus not only on traditional and asymmetric threats, but instability and crisis. Furthermore, NATO intelligence is engaged with political and military authorities to establish linkages between warning and precautionary measures to be taken by Alliance authorities upon warning.

Strategic Estimates: As noted at the outset of this chapter, NATO produces two grades of intelligence. One is *agreed intelligence* which has the full concurrence of all the NATO nations. The other is *staff intelligence* which is produced by NATO Headquarters and Command intelligence staffs and does not necessarily represent the views of all NATO nations. NATO intelligence could not produce a strategic estimate at the early stages of the Kosovo crisis because national defense intelligence senior authorities could not formally agree on the substance

of an estimate produced by a multinational working group of subject matter experts.

There is no solution to producing crisis management strategic estimates absent the will of nations to move quickly and decisively to agreement, which implies accepting the expertise of their intelligence experts and perhaps sacrificing some precision in the interests of responsiveness. Nations also must understand that, while such estimates are indeed strategic, the nature of crisis and conflict today is fundamentally different from that of the Cold War period. Today, events and factors driving strategic estimates have a major political component and are, therefore, volatile. During crisis management operations, estimating will probably have to be a rolling process with frequent reassessment required. The NATO estimates culture, established during the Cold War, must give way to a new intelligence culture responsive to the dynamics, ambiguities, and uncertainties of the new security environment.

Strategic Situation Reporting: NATO Headquarters intelligence performed this function satisfactorily, supported by the reporting of SHAPE JOC J-2, the NATO and selected Partner nations and ACE operational command echelons. Managing, processing, and compressing high volumes of data into highly aggregated, strategically relevant, political and military assessments with short-range forecasts was a major challenge. The high demand for situation reporting, the pressure of time and the necessary internal staff and command element coordination were additional factors making this a high stress endeavor. All of these considerations demanded a high degree of consistency in all staffs meeting their time windows for reporting up echelon with progressively higher degrees of data aggregation. This was only possible through the use of highly reliable digital information systems capable of handling large volumes of textual and graphical information for multiple consumers. A relatively high level of technical expertise in the use of digital information systems by all personnel, including flag and general officers, was essential to the management, coordination, and responsive delivery of briefings and reports.

Strategic Assessment: NATO Headquarters intelligence ability to produce strategic assessments was impacted by a number of factors; (a) insufficient staff with regional political and economic subject matter skills, (b) the time demands of accessing and managing high volumes of information (intelligence and open source), (c) the high tempo headquarters situation briefing and reporting regime, (d) the lack of an

intelligence basis in the form of integrated strategic assessments contributed by the nations, and (e) the lack of culture and experience in strategic crisis management campaign planning and management in NATO's senior political and defence staffs to drive intelligence requirements and effectively use intelligence as a management instrument.

Information Architecture and Intelligence Information Management: Although seemingly contradictory, NATO Headquarters intelligence was concurrently starved for intelligence and plagued by a glut of intelligence. From this contradiction arises the central issue of how to structure and manage high volumes of intelligence information, reporting, and dissemination using digital information systems and networks. Despite the challenges posed by digital system information management, the use of such systems was absolutely central to NATO's success in maintaining high tempos in operations, coordination, crisis management, and politico-military consultation at all echelons. Unlike NATO's analog and newer digital record communications systems, the digital wide area networks in use during Kosovo were not governed by any hierarchical reporting responsibilities or dissemination management scheme. Consequently, dissemination of intelligence reporting was too often on the basis of who one knows, not who needs to know.

The amount of duplicate reporting and circular addressing was excessive, creating a burden for users and communications capacities. There were no standards for textual and graphical data keeping and access across NATO echelons. Intelligence homepages often duplicated data holdings and reporting. Proliferation of intelligence homepages was, and continues to be, a problem. The number of homepages available to NATO and NATO nation intelligence officers is now in excess of 40.

It is a fallacious and dangerous assumption on the part of intelligence producers that once a report is posted on a homepage that it has been disseminated to those in need of it. In crisis operations especially, time does not permit searching Web pages for needed data. Key reports must be pushed to those who need them by e-mail. Pushing intelligence by e-mail however, is a slippery slope toward information overload, especially if there are no applications available for profiling and filtering e-mail into a coherent dissemination scheme at the user end of the chain.

Perversely, the most significant impediment to effective crisis information reporting and dissemination operations during Kosovo was posed by the nation contributing the most intelligence to the

Alliance, the United States. U.S. intelligence producers persisted in using U.S.-only intelligence information systems to disseminate intelligence released to NATO. Therefore a great deal, if not the bulk, of U.S.-produced and released intelligence resided and continues to reside in the electronic mail queues of U.S.-only information systems such as JDISS and SIPRNET. And, the bulk of U.S. released documents and products posted to homepages can only be accessed through U.S.-only systems such as INTELINK and INTELINK-S. Only one NATO nation has access to these holdings. It is the same nation who produced and released them and does not need them. There was, and remains, no way to digitally and automatically move released products across national and NATO security boundaries into NATO systems. During Kosovo, some U.S. personnel had the sole task of printing out NATO releasable material, digitally scanning the paper product, and loading the re-digitized document into a NATO information system. The awareness of this problem is now growing and hopefully will be less of a factor inhibiting future U.S. support of NATO operations.

Finally, NATO needs information tools. Kosovo was a Microsoft war. The most sophisticated information management tools available across most of the Alliance information structure were those found in the Microsoft Office application. Clearly, NATO needs more capable information management applications. NATO Headquarters intelligence requirements in this sector are documented, but by no means satisfied or necessarily agreed across the Alliance as the way forward.

Conclusions and Prospects

In the end, NATO achieved its objectives through Operation Allied Force. But, it is clear that the strategic intelligence contribution could have been much more sophisticated, effective, and helpful to NATO strategic military and political authorities. And, as noted, it is arguable that the NATO planning and crisis management culture was not sufficiently mature to direct or take maximum advantage of intelligence as a crisis management instrument.

In the decade following the Cold War, NATO Headquarters intelligence was indeed the forgotten echelon and was not restructured or adapted to implement the changing strategy of the Alliance or to meet the demands of the changing information technology or security environments. Consequently, NATO Headquarters intelligence was not

well postured for Kosovo crisis and intervention operations. An intelligence reform and modernization strategy has been adopted and approved by the Military Committee. It holds some promise for reforming and restructuring the Headquarters intelligence component, but the future of the Alliance's intelligence capability is ultimately in the hands of its member nations.

There are no professional or technical reasons preventing NATO intelligence from developing the capacity to support complex political, economic, and military intelligence operations. Given the wealth of regional, functional, and technological expertise available across the Alliance there is every reason to believe that NATO intelligence could achieve a level of collective excellence and synergy exceeding that of any single member nation. There are however, very serious reasons to believe that there is insufficient national and NATO institutional will to reform, invest in, and modernize the Alliance's intelligence capability to meet the demands of the NATO Strategic Concept and the dynamics of the strategic environment. Meanwhile, as the debate on the future of NATO intelligence continues, national intelligence restructuring, intelligence technology and military art march on and strategic environment challenges continue to change and develop.

¹The observations, judgements, and conclusions expressed in this article are the author's alone and do not necessarily represent those of NATO or the author's national intelligence authorities.

CHAPTER IX

The Kosovo Crisis and the Media: Reflections of a NATO Spokesman¹

Dr. Jamie P. Shea²

It has often been pointed out that today wars of interest, today which countries fight because their vital interests are at stake or because they are directly threatened, or because of territorial or dynastic disputes, are less frequent. They are being replaced by wars of conscience. These conflicts arise not because a country has any vital national interest in fighting, but because it feels a duty to uphold certain human rights and societal values against states that abuse those values vis-à-vis their own citizens. Indeed, it is because of the fact that in today's conflicts 90 percent of the casualties are civilians, compared with only 5 percent in World War I and 48 percent in World War II, that liberal democracies feel the need to become involved in order to save lives by putting a stop to persecution on grounds of ethnicity or religion. Wars of conscience pose considerable problems for the western democracies vis-à-vis the media. These new types of humanitarian interventions are allegedly conducted in the name of moral values and higher standards of civilization. As a result, the media increasingly expects that the military campaigns themselves should also be conducted in a more civilized way. This is clear in the growing demand that military interventions be legitimized through a U.N. Security Council Resolution or other grounding in international law. It is also manifest in the media's expectation that the extreme character of the use of force be recognized by liberal democracies and that they try to limit its effects as much as possible. Democracies expect the maximum political results from the minimum use of force. As a result, at the end of the 20th century the principles of the just war dear to Aristotle and St. Thomas Aquinas are making a major comeback.

There are four principles of the just war. The first is that the conflict itself must be a last resort. The second is that the means used should be proportionate to the ends pursued. The third is that there should be

a maximum degree of discrimination between military and civilian targets. The fourth and final principle is that the good that is procured by the conflict should outweigh the costs that inevitably have to be paid in arriving at that end. In other words, that the end justify the means. Conflicts are always measured in terms of the quality of the peace that they help create. The problem here is that even conflicts conducted to the most exacting standards of civilized behavior dear to liberal democracies cannot conform entirely to those four principles of the just war. It is the inevitable gap between expectation and reality that fuels much of the media's anxieties regarding modern-day warfare.

The Theory of the Last Resort

Obviously democracies want to be able to demonstrate that they have exhausted all possible diplomatic means to solve a crisis before they resort to arms. In the case of NATO's involvement in Bosnia, this meant hesitating for the better part of 3 1/2 years before engaging decisively in September 1995 when the Alliance bombarded Serbian artillery positions around Sarajevo to bring about an end to the siege of that city. More recently, in Kosovo it meant hesitating for the better part of a year before finally agreeing to launch Operation Allied Force, the 78-day bombing campaign against Yugoslavia. During that time much suffering occurred, and it is a fair point to argue that had the Alliance acted immediately, both in Bosnia and in Kosovo, much less force would have been needed to secure the objective and many lives would have been saved. Many experts today point out that had NATO sent gunboats to immediately respond to the Serbian artillery shelling of the city of Dubrovnik in 1991, the misery and destruction of the subsequent break up of Yugoslavia could potentially have been avoided. There would perhaps not have been 350,000 deaths, 2 1/2 million refugees, and untold disruption to the social and economic life of an entire region.

A last resort, whereby the international community exhausts every conceivable diplomatic means and sends innumerable envoys to the target region before concluding that force is necessary, often means that much more force has to be used, in a more decisive way and in more difficult circumstances later on to make up the lost ground caused by allowing the conflict to exacerbate while diplomacy runs its course. It can also mean forgoing the opportunity to strike an adversary when he is at his most vulnerable and when surprise will have its greatest

impact. A last resort policy gives an adversary more time to prepare—for instance in dispersing forces, hiding military assets, and deploying decoys. Nonetheless, an immediate military response is unlikely to be acceptable either to politicians or to public opinion. Diplomatic efforts are necessary to acclimatize public opinion gradually to the necessity of the use of force. Liberal democracies cannot justify the use of force on grounds of punishment or retribution alone. Force has to be another way of achieving the same overall political objective. Failure of diplomatic efforts also lends further legitimacy to the use of force. Conflicts are never popular with public opinion. The uncertainties that they cause can be countered only by the argument that there is no other choice.

The Principle of Proportionality

The same problems apply to the principle of proportionality, or the requirement that only minimum force be used to achieve a certain objective. These problems are all the more acute where, as in the case of NATO's conflict with Yugoslavia, war had not been formally declared and the Alliance stated that it was intervening not against the people of Serbia, with whom it had no quarrel, but against a rogue regime which was using unacceptable levels of violence to solve its internal problems. Regimes that acted in this way did as much a disservice to the interests of their own people as to the interest of a rival or adversary group, in this case the Kosovar Albanians. The Serbs in Kosovo also suffered under Milosevic's campaign of repression, both because of the violence that the campaign engendered and as a result of the widespread desire for vengeance following the return of the Kosovo refugees. Such double hazard gives the international community all the more justification for intervening as dictatorships tend to be a threat to their own citizens as well as to their neighbors. But once the decision to use force has been made, the pressure has to be decisive. Force has to make a significant impact and be effective to make a difference. If force is used in too gentlemanly a way, then it could convey the opposite impression to an opponent, that is to say of weakness, of lack of resolve, of a definite limit to the amount of force that the Alliance is prepared to use. It can therefore even encourage the continuing defiance and resistance of the opponent. The proportionality debate also extends to the choice of weapons. Cluster bombs, for instance, are highly effective against airfields and fielded

forces, but 10 percent do not function and if they go astray they can inflict much harm on civilians. Should we use them?

Conflicts presuppose the willingness to inflict a considerable level of damage to be effective. In the Kosovo conflict, Milosevic showed an unexpected willingness to tolerate a very high degree of damage before being prepared to meet the essential conditions of the international community. As with other dictators, he did not have to worry about serious political opposition, and he could exploit his control of the media to hide his military losses in Kosovo from his domestic public opinion. So it was essential for the Alliance to be ready to escalate beyond the point at which Milosevic was willing to surrender. This involved the intensification of the air campaign over 78 days during which a number of strategic targets in Yugoslavia were destroyed, targets which were chosen specifically for their military rationale but which also had a major relevance to the civilian community, such as roads, railways, bridges, electricity switching stations, radio relay sites, and petroleum refineries. The irony here is that force has to create disorder in order to ensure order. Often the situation has to get worse before it gets better. The media seizes on this aspect of conflicts. It is easy to argue that the decision to intervene has actually made matters worse, for instance in turning a humanitarian crisis into a catastrophe. During the Kosovo conflict, a frequent question was: "Hasn't NATO bombing only provoked Milosevic into expelling hundreds of thousands of Kosovar Albanians? Instead of stopping a humanitarian disaster, haven't you caused one instead?" The media is more interested in short-term consequences than long-term objectives. Yet all military interventions are based on the premises that you have to exacerbate a crisis in order to solve it. The problem is that the media wishes to have it both ways. Before the military intervention it focused on the risk of inaction. It accused NATO of making empty threats and of allowing Milosevic to act with impunity. After the intervention had begun, it concentrated instead on the risks of action.

Every refugee arriving in a camp in Macedonia or Albania said that it was not NATO which was the cause of their leaving, but rather Milosevic's soldiers. But it proved difficult to make the case that NATO's action had not made an already bad situation far worse. What policy makers needed to get across to the media and public opinion at large was the message that sometimes the situation even for the victims may have to get worse before it can get better. Not to do anything would

not have been to save the lives of Kosovar Albanians, but rather to abandon them to perhaps a slower, but at the same time equally relentless campaign of persecution and denial of basic human rights. Now, after some months of disorder, the refugee exodus has been reversed. Indeed over 650,000 Kosovar Albanian refugees have returned to their homes with unprecedented speed.

The Next Principle Is That of Discrimination

There has been spectacular progress over the past decades in refining weapons to make them increasingly accurate against military targets. We now have precision-guided munitions, weapons guided by lasers, and better mapping and computer technology to ensure that weapons are delivered to their targets with an accuracy that would have been unheard of just a few years ago. Computers now calculate the precise aim points of munitions to ensure that collateral damage is kept to a strict minimum. For instance, attacking the building from one side to ensure that on the other side civilian buildings are left as intact and as unaffected as possible or that the blast damage is kept to a minimum by precisely calculating the angle and the speed of the impact of the munitions. This has become a genuine science and with very impressive results. In Operation Allied Force, NATO dropped 23,000 bombs, whereas only 30 were misdirected and failed to hit the intended target accurately. This is a fraction of 1 percent, a degree of accuracy that has never been achieved before. The paradox here is that as the weapons become more accurate, the media and public opinion in general are all the more shocked when things go wrong, as inevitably they do in warfare. The incredible 99.9 percent success story is ignored; the 0.1 percent or failure, statistically insignificant, becomes the central drama of the conflict and the yardstick for judging NATO's military and moral effectiveness.

Even the Best Training and Technology Cannot Prevent Accidents Occurring

We had in Operation Allied Force the very impressive video footage of an aircraft attacking a railway bridge. It was clear that at the moment the pilot released his bomb there was no train on the bridge but a split second after the bomb had been launched, what happened? A passenger

train suddenly appeared with the tragic results that everybody knows. That was really something that could not humanly or technologically have been prevented. And so as public opinion becomes increasingly used to the idea that there can be effective discrimination between military casualties and civilian casualties in modern conflicts, the loss of innocent lives becomes all the more scandalous and unacceptable. It increasingly carries with it the risk that an international coalition like NATO, because it arguably cannot avoid spilling a certain amount of civilian blood during a conflict, will be seen as just as bad as an authoritarian regime like that of Milosevic which has been deliberately killing its own civilians. Discrimination simply cannot be 100 percent effective, unless countries refrain from sending their armies into battle in the first place. All the more so as certain military targets have a civilian use, such as bridges or roads or railways. Even limited force will be inevitably disrupting the civilian economy causing unemployment or shortages of electricity in schools and hospitals. This can at best cause inconvenience to civilian activity and at worst lead to civilian deaths or suffering. During the Kosovo crisis I was impressed by an article in *Le Monde* by Claire Trean in which she said, "So far the problem with this conflict is that the only people who are dying are civilians." What she meant was that NATO pilots were not being shot down in the judgment of the media because they were flying at an excessively high altitude. On the other hand, NATO was not seen to be successfully attacking the Serbian units in the field in Kosovo. The media demanded that the Alliance focus its air strikes on those responsible for the killing and the mayhem, which were the Yugoslav fielded forces in Kosovo. In any conflict, carrying convictions does not only mean having a convincingly superior moral cause but equally being militarily effective in pursuing that cause. Morality without effectiveness is as bad in the eyes of the media as effectiveness without morality.

But to my mind it would have been wrong to place the lives of our pilots at greater risk by forcing them to fly at 10,000 or 5,000 feet, simply to demonstrate that they were facing the same risks of casualties as the Yugoslav soldiers in the field of Kosovo or even civilians. Creating an artificial equality of suffering would have been absurd, not least for psychological as well as military operational reasons. Had we lost six planes a night as Milosevic boasted before the campaign that he would be able to achieve, public support would have rapidly disintegrated in the Alliance member states for the continuation of this conflict. The price would simply have been seen as too high. At the same time,

Milosevic would have no doubt been encouraged to continue to defy the international community on the safe assumption that he was inflicting unacceptable military losses against us. Ultimately one of the factors that must have made life miserable for him was the fact that every morning his generals would visit him and tell him that during the previous night no NATO aircraft had been shot down, despite their very intensive anti-aircraft fire from SAM 3 and SAM 6 missiles and other types of anti-aircraft that NATO pilots were subjected to on practically every mission that they flew. Nonetheless the media in the liberal democracy find it difficult to accept that increasingly the military forces on either side can protect themselves through decoys or tactics or training or technology, whereas no such protection is afforded to the civilians that continue to suffer disproportionately. This criticism is all the more acute when the sole purpose and rationale of an intervention by the NATO Allies in a crisis like that of Kosovo is a humanitarian one. The media finds it difficult to accept that sometimes civilian lives will be put at risk or even expended in accidental strikes in order to save the lives and the well being of the overwhelming number.

Finally I come to principle number four of the Just War: the notion that the end justifies the means or that the good, which results from the conflict, is greater than the price that had to be paid. Here I think nobody could deny today that this result has been achieved in Kosovo. Kosovo is now free even if formally it is still part of Yugoslavia. The Kosovar Albanians are now able to go about their lives without fear of persecution or at least mass persecution, even if we are still not in a position to prevent individual acts of revenge, inflicted by one side against the other, attacks which are understandable even if lamentable after the terrible experience that Kosovo has been undergoing over the past decades. The international community is committing itself to a major program of reconstruction, not simply of Kosovo but indeed through the Stability Pact of the entire region of the southeastern Europe. The Yugoslav security forces have been forced to leave Kosovo. The problem here is that while NATO's campaign was still ongoing, it was difficult to prove to the media that this result would in fact be achieved. This is rather like the analogy of an insurance policy. You pay your money every month whereas the benefits occur only in the future. In other words, you feel the pain but you don't yet perceive the gain. During Operation Allied Force the costs every day of the conflict could be palpably felt. They could be filmed by the international

media and transmitted in real time by satellite to TV audiences across the world. We saw multiple images of suffering, of refugees in camps having lost everything, of families being separated, of women who had been raped or badly abused. And we saw of course what Milosevic wanted Alliance public opinion to see: the NATO mistakes, the incidents in which bombs had hit the wrong target, causing loss of life and injury to many innocent civilians. Milosevic was the aggressor but he used the Western media to portray himself as the victim. The public was clearly aware of the conflict and of the immediate price that was being paid. But we could not film the future. We could not present the result that now we see which was at that moment still hypothetical. Public opinion in modern conflicts is much more likely to be critical because it is presented by the media only with the short term side effects or the short term consequences or the short term costs of military action. It is not presented with the long-term benefits. Conflicts in other words are justified only in retrospect and in light of the final results. Nothing succeeds like success and nothing fails like failure. You can only convince the media by winning. A conflict is deemed just only if it succeeds. Results impress the media more than reasons.

The media in liberal western democracies expect standards of perfection in the conduct of civilized warfare that reality cannot really match, notwithstanding the enormous efforts of NATO politicians and NATO military commanders to take every conceivable precaution to minimize the harmful consequences to civilians and to the civilian economy of their opponent. Notwithstanding the fact that it was the opponent who was the first to resort to arms and to break the code of civilized behavior. There is in short a perception gap between what is feasible and what is desirable and it is into the gap that the media pour with the results that we saw on many occasions in Operation Allied Force. This can take several forms particularly in an age where the media, via satellite and cable TV and 24-hour news channels can have the story in real time. The media no longer need spokesmen to present them with the facts. They are fully able to find out those facts themselves and often much faster than spokesmen even can. 24-hour TV means that every event, every incident can be dissected, analyzed, and commented upon almost ad nauseam. After watching a conflict 24 hours a day on TV even the shortest conflict in human history (and with 78 days I believe Operation Allied Force will go down in history as one of the shortest conflicts) can seem to the average viewer to be lasting an eternity.

The Media Likes Conflicts

The media are attracted to conflicts because they are larger than life events. They generate dramatic pictures that speak for themselves and maximize the appeal to the emotions of viewers. They also contain a variety of different stories. There is the story of the titanic struggle between nations, there are the human-interest stories of individual tragedies, and there is the opportunity to show extremes of human experience. And conflict, fortunately for Western liberal democracies, is sufficiently rare these days to be different and newsworthy. When it happens it excites enormous interest. Even the battle of the airwaves can become a media story in its own right as we saw during Operation Allied Force; and as we see in the desire now of some TV channels to make programs entirely devoted to the media war. Conflicts increase the ratings and give many foreign and defense correspondents a temporary upper hand over their more visible rivals covering domestic affairs. On the other hand, policy makers do not like crises. Crises bring anxiety, tension, and uncertainty. None of us know how we are going to perform, whether we are going to have a *good war* or a *bad war*, whether we will be up to the challenge or be found to be deficient, whether our decisions will prove to be the right ones or the wrong ones, and how the whole thing is going to end. Above all, we never feel fully in control of events. It's not surprising that policy makers do whatever they can not to find themselves caught up in running a conflict. That is another reason for them to exhaust all the diplomatic means of resolving a conflict first.

The ability of the media to dramatize events and create a global audience for a conflict puts policy makers under pressure to take decisions faster and with less time for reflection than at any previous time in human history. This increases the chances of those decisions being the wrong ones. Because in today's liberal democracies the use of force is seen as the ultimate extreme option available to governments and because conflicts are rare, even just wars do not explain or justify themselves. They have to be sold to public opinion much more than the wars of imperial conquest of the past. Humanitarian interventions are more controversial and public opinion—not to mention the press—is less deferential. This is particularly true when the conflict is against another European state at the end of the 20th century. In today's conflicts political leaders spend as much time explaining or justifying a conflict to their

public opinion and to the media as they actually do running them. A very senior British defense official complained to me that he spent most of his time preparing for his daily press briefing and trying to anticipate the difficult questions he would be asked. He had less time to be involved in his primary role of running the conflict as a result.

Despite all this effort, Foreign Ministers, Defense Ministers, or serving Chiefs of Defense are at a disadvantage in that they can be portrayed by the media as biased or unreliable witnesses because they have to say that, don't they? And as soon as the conflict is not terminated in 48 hours, out come the talking heads to say: well it hasn't worked with the speed of instant coffee, therefore it is not going to work. And after 3 days to a modern media that dissects, analyses, and comments extensively on every single incident an air campaign is already too long. If you haven't yet succeeded, you must have failed—although any air campaign is obviously a work in progress which will take some time to produce its full effects. During Allied Force clearly it was going to take some time to substantially degrade the Yugoslav fielded forces in Kosovo and generate the military pressure on Milosevic to pull them out. Even if the air campaign had been more instantly effective, Milosevic would still have held out to test Allied resolve and to see if Russia would cooperate with the Alliance against him or not. But the fact that Milosevic did not give in on day one did not mean that he was not going to give in the future.

The media is primarily interested in the instantaneous image, which becomes the reality of the day. In other words they are interested in news and the problem here is that news is often not important or rather because it is news does not mean to say that it is always important. The Djakovica convoy incident in which perhaps 10 to 20 people died became the dominant news story for five days. During those five days 200,000 people were expelled from Kosovo. Was that not more newsworthy than the 10 to 20 people who died because of a NATO accidental strike against a convoy? I would argue that it was. It was much more intrinsic to the real story of what was going on inside Kosovo. But why did the media not report that? Answer—no pictures. And this is a fundamental lesson that we are going to have to learn. It is quite simple: no pictures, no news. In other words I, as NATO spokesman, everyday was using thousands of words to explain what was going on. I was talking about atrocities, about summary executions, about lootings, about house burnings, about rapes; I was talking about

identity thefts of people's documents. None of that was believed because I could not present the photographic evidence. In much of the press it was called rumor and speculation, even though now journalists are coming up to me and saying: "Sorry, if anything you were far too conservative in your estimates of what was going on." The International Criminal Tribunal has already discovered 200 mass graves and crime sites and my estimate of 4,600 Kosovar deaths at the hands of the Yugoslav security forces is less than half of the current conservative estimate. But I didn't have any pictures and if you can't provide a picture, there is no story, even though you are describing the fundamental reality of what is going on. But if TV can provide a picture of a tractor, which has been accidentally struck by NATO aircraft, that becomes the reality of war. The individual incident is played up and the general trend is played down. Context suffers. The conflict is portrayed by the media as a series of individual newsworthy incidents, some of which are decisive to the outcome of the conflict, others of which are totally irrelevant. There is little sense of fundamental dynamics, of underlying currents or of probable outcomes.

Pictures Are Believed

In sum, pictures rule in these situations. Pictures are believed, even if they are atypical or distorting; words are distrusted even if they are true. I remember many times urging the Pentagon (and other Allied countries that had satellite photography) to give me a picture of a mass grave, or of villages that were burning, or of internally displaced persons inside Kosovo to show at my daily briefing. Otherwise nobody was going to believe me. I could even be accused of propaganda.

Essentially this means that your adversary has an advantage over you, at least initially. Why? Because Milosevic controlled the pictures. There was a group of western journalists in Belgrade. He gave them their visas. If they did not behave, he took away their visas. In fact over 50 western journalists were expelled by the Serbs during Operation Allied Force because they refused to be docile, or asked too many embarrassing questions. That is the big difference between their system and our system. Any journalist can come to one of the NATO press conferences and ask every embarrassing question he likes and still be welcomed back the next day. If a journalist had asked the same question at one of the non-existent daily briefings in Belgrade of the Yugoslav

official, the visa would have been removed. So in other words, in order to be able to stay in Yugoslavia and be able to report, journalists had to play by the rules and accept certain restrictions.

That meant that Milosevic, who controlled the pictures, could show the western media the pictures that he wanted them to see of NATO's collateral damage and make sure that none of the pictures that would have embarrassed him, the real pictures of the war, the atrocities, the mass graves, the burning houses, were never filmed or were never released because of censorship. Yugoslavia treated this as a war and played by the rules of war—censorship, control of the media, pooling—whereas we treated it as a conflict and played by the principles of transparent open democracy imposing no restrictions whatever. It meant that we were dependent on a brave Kosovar Albanian who made a video film of one particular massacre and managed to smuggle it out. When that played on CNN, after about 5 or 6 weeks after the beginning of Allied Force, it was the very first pictures that anybody had seen of what was actually happening inside Kosovo. He who controls the ground controls the media war, even though he who controls the air controls the military strategy for winning. One of the key challenges during the Kosovo crisis was to convince journalists that we were not losing the media war while we were in fact winning the military conflict. Milosevic's control of the pictures lent credibility to this—ultimately wrong—perception.

I would have asked many of those journalists in Yugoslavia to have reported openly that when they were taken in a closed bus to the site of a tractor attacked by NATO that they couldn't film all of the burning houses that they saw on the way, or why they could not film Pristina, or Pec, or the other places emptied or decimated by Serbian forces. There were some limp attempts by many TV stations to put a kind of health hazard warning at the beginning of the news saying: "Our reports from Yugoslavia are subject to certain restrictions." But it was said in a pro forma way that did not convey the reality of the censorship particularly forcefully.

This brings us back to another problem in dealing with the media in times of conflict. The media believes that objectivity requires a debate. If you do not present contradictory views, you are not being objective. However, logically objectivity is not simply criticizing your own side all the time. But for the media it is often precisely that. The media have a tendency to believe that every time a NATO spokesman appears there

has to be a Yugoslav Foreign Ministry spokesman on at the same time. As if it is somehow unhealthy to have only me giving my views without the rebuttal appearing alongside me to ensure objectivity, or as if an official view has to be immediately contrasted with its opposite or else the media are not doing their job. This lends credence to the notion that official views are automatically suspect or, at the minimum, partial.

Sometimes this sense of truth (as the systematic questions and challenging of official views) can be taken to extremes. I was invited on to a program on the ITV channel in the UK called *NATO on Trial*—NATO On Trial—as if what we were doing for a humanitarian cause was equivalent to a criminal action which had to be judged by putting the NATO spokesman literally in this program in the dock. I found myself in a kind of artificial studio court being cross-examined by lawyers as to the morality of our action. Again, this reflects a kind of increasing distrust among many media of government officials, or spokesmen, as if somehow our views are automatically suspect and have to be either cross-examined by lawyers or opposed by Yugoslav Foreign Ministry spokesmen who, incidentally, came out with far more outrageous statements than I ever did.

So how are we going to deal with this? We have to develop what I would call a compensation strategy for dealing with the way in which the media selects small stories and presents them as the whole truth, confuses the symptoms and the causes (i.e., the refugees pouring out of Kosovo are the result of NATO air strikes, not the reason why NATO felt obliged to become involved in the first place) and constructs the story from the picture, rather than the other way around. We have to confront head on the tendency to use the concepts and language of moral equivalence, or to present the views of the adversary-aggressor as somehow just as important or worthy of attention as those of western democracies themselves.

The answer is to use two types of argument and to use them all the time. The first one is to stress repeatedly that we are morally right. Even if we haven't been able to spare all civilian lives that does not in any way detract from the moral superiority of what we are doing. We have right on our side that is clear. All the time we must return to the fundamentals. Why are we there? Because Milosevic is a certain type of individual. Because he has been running his campaign of ethnic cleansing for a long, time. Because he has expelled so many people.

Ultimately, NATO's greatest embarrassment also proved to be its salvation. In expelling hundreds of thousand of Kosovar Albanians, Milosevic cruelly exposed NATO's strategy to prevent a humanitarian disaster; but he also highlighted the barbaric nature of his regime and solidified Western media and public opinion pressure against him. It is essential to continue to restate all the time why you have right on your side and to continue to reiterate all the time what your objectives are, and that you are not going to give up until those objectives are met. This may be extremely repetitive. It may be even boring. My colleagues used to laugh when every time in a briefing I would repeat NATO's objectives. They would say: "Don't you get tired of saying that?" The answer is no because the more often you say it the more the media believe that you are not going to back down. And the greater the media's belief in your overall resolve and determination, the more all of your messages and statements will be judged as credible and reported at face value.

It is equally important to use people like me, or at least to rely exclusively on people like me. This may strike you as somewhat ironic because you have invited me here today because you think I played a role in NATO's media operations. My role was very modest. The important thing is that government leaders go on TV and reach out to their public opinions. They are the elected people. They are the people who have the voters' trust. They are not paid communicators like myself. Some of their performances were absolutely critical. President Clinton, Prime Minister D'Alema, and Chancellor Schroeder all engaged their national audiences on a constant basis. Virtually every Alliance leader became involved in this effort. They were on TV practically every day. This is important because visible leaders inspire public confidence. Invisible ones suggest that something is going seriously wrong. Leaders have to dominate the media and not be dominated by it. Successful conflicts cannot be media driven. Too many decisionmakers wake up in the morning and if the editorials and columns in the newspapers are critical they think they are losing the media war. It matters to us because newspaper columnists write columns for us mainly, not to influence public opinion but to influence politicians, opinion leaders and not the least of all each other. The op-ed page of the International Herald Tribune is where elites commune with each other. Nobody else reads it. It is very interesting in terms of debate. But one advantage of TV over

newspapers is that we write the script and millions more listen to it than is the case with newspapers.

The channels are now international, 24-hours-a-day channels, which repeat their news at least every hour. And one advantage of 24-hour TV is that they have a lot of space to fill, and they want to do it cheaply. The best way of filling an hour virtually cost-free is to put NATO's daily briefing on the box. It suits CNN or BBC World perfectly to have a daily show. They don't have to make an Elizabethan costume drama and spend millions to entertain the viewers. If you give that briefing at 3 p.m. in Paris, it is 9 a.m. in New York, in Hong Kong 9 p.m., and in Sydney people may be having a whisky toddy nightcap at 11 p.m., and still tune in. At 3 p.m. Paris time it is 6:30 p.m. in Calcutta and across most of India when most people are awake in the world. 3 p.m. is the time when the largest number in the world is watching TV. So you achieve a world audience. In other words, concern yourself principally with TV and radio. The written press will always be the written press. Treat it with respect but in a crisis or war situation do not worry unduly about what it says. TV is the medium of wars like newspapers are the medium for peacetime debates. So use your leaders and use TV and radio first and foremost. That is the recipe for success.

Winning the media campaign is just as important as winning the military campaign. Why? Because you keep your public opinion behind you; secondly, you convince your adversary that you are not going to give up. If you are taking the media campaign very seriously, it means that you take winning seriously. That is a very important part of the psychological battle in convincing your adversary that under no circumstances are you going to back down. Milosevic did not see at first hand NATO's military campaign in Kosovo and perhaps was not being told the truth from his own generals as to what was going on. But he watched CNN every day and he saw our battle damage assessment. He saw the pictures of all of the bridges and factories that had been damaged in his country and for Milosevic watching every day this must have been very depressing stuff indeed. Ultimately we were more successful in using the media to intimidate him by presenting reality, than he was able to use the media to intimidate us, by presenting propaganda.

It is very important to take the media as seriously as the military campaign. You need therefore a proper organization. Why would you have a sloppy organization in which you allow President Clinton to

give a major address at exactly the same moment when President Chirac is giving his address? If you can deconflict these events because you have a good organization and persuade President Clinton to give his address at 4 p.m., and President Chirac at 6 p.m., you achieve double the airtime. You can also try to advertise these speeches in different countries to maximize their impact. Part of being convincing is to saturate the airwaves. Our credo at NATO was just to be on the air the whole time, crowd out the opposition, give every interview, and do every briefing. It helps to have recognizable faces on the air that consistently symbolize the Alliance. The Yugoslavs, in my view, were less effective because they did not have a recognizable Spokesman of their own. Their leader Milosevic rarely appeared.

We had an MOD briefing from London late in the morning and just as the audience was switching off from that, on came the 3 p.m. briefing, and as soon as the 3 p.m. briefing was off the air up jumped the Pentagon, the State Department and the White House. We occupied the whole day with our information. And the more we did, the less the media put on talking heads and others who could be nullifying our effort.

And finally, why do you need a media organization? Because basically you have to help other Allies who might have difficulty with their own media, with their own public opinion. If you are running a coalition military campaign, if one country has a problem it soon becomes your problem. By having an organization in which you are in close coordination with capitals you can work out what kind of message can help a particular government through a difficult period.

At the end of the day what is important? The criteria for success are threefold. First of all, have you convinced your own public opinion? The answer is, in Allied Force we did. Our publics were not enthusiastic—who is about a military conflict after all? But they did basically believe that ultimately, despite the problems and the ups and downs, we were justified in doing what we did. Because we told them and we kept on telling them that. And even if the media was not particularly convinced by NATO's operation, we used the media to communicate to the man on the Clapham omnibus. He is the person who counts in these types of operations through his support in opinion polls.

Secondly, did we convince our adversary? Clearly we did because the fact is, whether you like it or not, Milosevic gave in; that is the fact, that

is the bottom line and clearly I would like to think that our media operations had a minor role in bringing him to that.

And then finally let me tell you the best thing of all. Did we convince the victims, the Kosovar Albanians, to stay the course? We did. When I was in Pristina with the Secretary General a lady came up to me and said: “Mr. Shea, you were our lifeline to optimism”—Lifeline to optimism. Every day as the Kosovar Albanians were hiding in their apartments, too frightened to come out; they could watch TV and listen to the radio. The one thing that Milosevic could not take away from them was their satellite dishes and their TVs. And what did they watch every day? At 3 p.m. the NATO briefing. People came up to and told me that those briefings, not just mine but the briefings by the Secretary General, and other Alliance leaders, has all convinced them that they should not despair, they should hold on, that NATO was going to come and help them. In fact Veton Surroi, one of the most important political leaders whom I met briefly, told me that he was hiding in a basement with 19 others and every day after the briefing he had to translate every single word I spoke except, he said, for my terrible jokes that he couldn’t manage to translate. We managed through our briefings to morally sustain those Kosovar Albanians through what must have been an ordeal for them, to give them hope, to make them trust western democracy.

And therefore despite the problems that the Kosovars may be having at the moment with the transition to a new society, the fact that we were able to bring NATO into their homes for 78 days gives me some hope that they will build a future consistent with NATO values.

Lessons Learned

In conclusion, what are the key lessons that we have learned at NATO Headquarters from our experience in dealing with the media during Operation Allied Force?

Lesson One

Do not expect perfection in dealing with the press in a crisis or conflict. Crises and conflicts inevitably polarize positions. A critical press does not mean that NATO is failing to put its message across as we discovered during the Kosovo air campaign. Conflicts especially

produce more than their fair share of confusion and uncertainty. We will probably never have enough accurate information in real time to keep the press happy. There will inevitably be accidents and unintended casualties that the media will highlight despite NATO's best attempts to keep them focused on the big picture and on the moral justification for our actions. In a conflict there will always be an opponent and that means a certain amount of propaganda, disinformation and simple counter arguments that we will have to deal with. Finally, the media will give plenty of prominence to the talking heads, those retired generals and admirals as well as academics, who will claim to have a superior strategy and who will judge that lack of instant success represents failure. With 24-hour TV, every event will be dissected and analyzed in every detail and any conflict will begin to seem lengthy after just a few days. Moreover as NATO is an open institution where the press can gather in strength and write what it likes without fear of sanctions, our activities are bound to be subjected to more critical scrutiny than those of our opponents where press freedoms are likely to be curtailed. Belgrade during Allied Force was a case in point.

During times of crisis and conflict NATO's press relations will inevitably be more difficult than during peacetime. We are obliged to send strong messages and stay on-the-record whereas the media want more backgrounders and the inside story. Moreover, conflicts are not popular with public opinion even at the best of times. Public opinion will be more robust in certain Allied countries than in others. Therefore NATO's press strategy has to be geared towards the optimal selling of the Alliances' basic arguments and objectives and the optimal down playing of the manifold criticisms from the media that the resort to arms and the always less than ideal conduct of military operations are bound to endanger.

How can this be done?

Lesson Two

We need to strengthen our press and media organization from the moment NATO's involvement in a conflict or major crisis appears inevitable. Setting an organization up only during the middle of the air campaign and in response to our earlier mistakes was better than nothing, but far from ideal. The NATO Press Service is staffed for normal peacetime operations. Clearly it will need reinforcements to handle a news story of global significance and for more than a few days.

Therefore, something like the Kosovo Media Operations Center (MOC) should be established as quickly as possible.

At the same time, the MOC has to be seen as the creation of NATO Headquarters and not something that is imposed on us by capitals. We do not want to see again headlines such as “Spin doctors from No. 10 take over NATO information effort.” During Allied Force the perception that spin doctors, more interested in message than accuracy, were running our public information activities was damaging and remains a stereotype impression.

The essential functions for the MOC are:

- Grid—planning events, coordination, deconfliction;
- Media monitoring—all media—home and opponent;
- Rebuttals;
- SHAPE liaison/military information; and
- Drafting, research, and analysis/message formulation.

Lesson Three

During the crisis period the provision of military information from SHAPE must be improved. Much of the damage to our credibility during Operation Allied Force was inflicted during the first few weeks when the SHAPE/NATO information network was not functioning optimally. The press criticized us not so much for the fact of causing collateral damage but for the confusion and delay in explaining exactly what had happened. The SHAPE information network has to be institutionalized. During Allied Force we were far too dependent on one or two people from capitals who happened providentially to have a good source at SHAPE and were able via the back channel to obtain information quickly. In the future there has to be a unit at SHAPE that is responsible for investigations and rapidly answering requests for information from NATO. We found out during Allied Force that when we were unable to explain an incident because of a lack of information the story would play for days in the media. When towards the end we were able to give information quickly, the story disappeared almost immediately.

Lesson Four

We need to know much more about our opponent in a crisis or conflict. During Operation Allied Force it was several weeks before we had people knowledgeable about Yugoslavia in the MOC or started to monitor the Yugoslav press or TV closely. Milosevic's propaganda sometimes caught us by surprise. If we had had this expertise from the beginning, we could have anticipated some of Milosevic's moves and learned to counter them better. Equally, the intelligence community has to provide us with more information about our opponents that we can use to support our cause. Far too often, when I came across interesting information, I was told that it was classified and therefore could not be used publicly. This did not mean that it did not emerge an hour or so later in the Pentagon briefing.

At the same time, if our opponent has free and unimpeded access to our media, we need to be more dynamic and creative in obtaining access to his public opinion to level the playing field. This is not easy in a dictatorship where the media is tightly controlled. During Allied Force, we had ideas to set up a radio station to broadcast into Yugoslavia, to use aircraft to beam in radio programs, or to help existing radio and TV stations widen their spectrum in Yugoslavia. However, none of these ideas were exploited before the end of the air campaign. We need to have media planning for such a pro-active approach better prepared next time.

Lesson Five

In the TV age, pictures are crucial. The Serbs had the advantage over us in that they could generate pictures from the ground, usually of NATO's collateral damage, whereas we often could only counter with words. The press often believed Milosevic's pictures more than they believed NATO's words. Of course since Western media have entered Kosovo on the heels of KFOR with their cameras we have been vindicated. But it would certainly help if we could show more photographic evidence to support our allegations (for instance mass graves or burning villages in Kosovo). We had some of this during the conflict, and it was generally effective, but more is always useful.

Lesson Six

One thing that we did well during the Kosovo crisis was to occupy the media space. By having a morning briefing and an afternoon briefing at NATO headquarters, and having also every lunchtime London MOD briefing and the Washington briefings in the afternoon, we created a situation in which nobody in the world who was a regular TV watcher could escape the NATO message. It is essential to keep the media permanently occupied and supplied with fresh information to report on. That way it is less inclined to go in search of critical stories. The off-camera briefings at 11 a.m. and overnight written updates certainly helped in this connection. We were also always able to have a briefing on hand to react to breaking news or Serbian disinformation that might otherwise have remained uncorrected until the following day. Having leaders of one country address public opinion in other countries via TV appearances, speeches, Op-Ed articles, and interviews can help in this respect.

One thing that we could have done better during Operation Allied Force was to track public opinion trends in those Allied countries that did not have a supportive public opinion and devise more active strategies to reach the media in those countries. Two of our three new Allies had certain difficulties in this respect which we did not really respond to as we might have done. Also key neighboring states such as Romania, Bulgaria, and FYROM had media and public opinion problems that could have impacted negatively on their solidarity vis-à-vis the Alliance. We could have done more to support them in our press activities. We will need in future a team to monitor the situation in certain sensitive Allied and partner countries and to devise specific media campaigns in cooperation with the national authorities.

A Final Thought—Crisis Management Exercises

The prominence of the media during Allied Force clearly indicates that the all-intrusive nature of press relations to an Alliance in conflict is still under-played and under-exploited in NATO's crisis management exercises. We have to redefine these to give media activities and media training a much more central role in line with reality and our own experience. The media is not an optional add-on; it is key. The NATO Press Service has to be more involved in the scenarios and planning

for crisis management exercises. We could also consider recruiting journalists to create a more real-life atmosphere with actual press conferences, media reporting, and feedback. *Affaire à suivre*.

¹Address to the Summer Forum on Kosovo organized by the Atlantic Council of the United Kingdom and the Trades Union Committee for European and Transatlantic Understanding. Reform Club, London, 15 July 1999.

²The views expressed in this chapter are those of the author alone. They do not represent an official position of NATO.

CHAPTER X

Operation Allied Force: The Media and the Public

Pascale Combelles Siegel

Amid the discussions of Allied Force, both during and after the campaign, many have argued that NATO constructed an ineffective information strategy and conducted it poorly. Some assert that Milosevic—not NATO—provided the best rationale for supporting the campaign through the mass deportation of ethnic Albanians begun toward the end of March 1999.¹ Others argue that Milosevic’s courtship of the international media allowed him to manipulate Alliance resolve and strategy. From his vantage point in Macedonia, one U.S. officer viewed the situation as follows:

*Milosevic is winning the information ops, the perception management. He’s the underdog and everybody else looks like a bully ganging up on him.*²

Subsequently, official lessons learned efforts have identified information operations and Milosevic’s ability to put his message in the Western media as a source of vulnerability and reason for concern. Testifying before Congress, Chairman of the Joint Chiefs of Staff General Shelton, USA, and Secretary of Defense Cohen commented that “the conduct of an integrated information operations campaign was delayed by the lack of both advance planning and strategic guidance defining key objectives.”³ Admiral James Ellis, USN, Commander JTF Noble Anvil, argued that Serbia was able to launch its own disinformation campaign via the international media to gain sympathy for its cause and disrupt NATO’s information superiority. “The enemy was better at this...and far more nimble.”⁴ In their lessons learned, the French Chief of Staff similarly concluded that Milosevic successfully targeted specific Western media to foster his goals.⁵ All of this suggests the importance

of the media as a battlefield in today's operations and each suggests a belief at senior military levels that the Alliance lost on this battlefield.

Prior to Allied Force's commencement, NATO leaders knew the fate of the operation would be at least partly decided in the media arena. NATO is composed of democratic nations and, in democracies, media reporting can greatly influence policy makers. With combat operations, the media's non-stop coverage of operations exerted intense pressure on Western officials to document their actions and release information relevant to the conduct of operations. This intense pressure sometimes collided with concerns over protecting operational security. Finally, media coverage of collateral damage incidents allowed tactical issues to have strategic, worldwide political repercussions to the point of threatening coalition resolve to continue the campaign.

As the Yugoslav authorities could not (and apparently did not) expect to win in a conventional confrontation of forces lined up on the battlefield, they exploited every possible issue in the marketplace of ideas to threaten the viability of the coalition. In that respect, the war was as much about the perceptions of weapons dropped as it was the actual physical affects achieved by those weapons. (Thus, is battle damage assessment (BDA) a question of analyzing physical effects or, more appropriately, of understanding psychological implications of the perceptions of those attacks?) One could argue that Kosovo was a deconstructionist war since perceptions mattered as much—if not more—than reality. In fact, one could argue that in Allied Force arguing for a distinction between perception and reality might be at best a coffeehouse argument as, for decisionmaking, perception is reality.

Information strategy contains many elements, including intelligence gathering, psychological operations, and public affairs. For much of this, the media is a battlefield, with the combatants engaged in both open and secretive clashes. This chapter focuses on that aspect related to open relations with the media, commonly referred to as Public Affairs in the United States, but called Public Information within NATO. Within the context of the media as battlespace, Public Information is thus a weapon in the commander's arsenal. This chapter reviews this particular weapon system's use and effectiveness during Operation Allied Force.

This chapter analyzes NATO public information during Operation Allied Force. Contrary to official folklore, I argue that NATO won that war—the battle for public opinion within NATO and around the world despite the

many shortcomings and errors of NATO and NATO nations' public information efforts. I also argue that many NATO errors could have been prevented had NATO adopted alternative policy and organizational measures.

To clarify how NATO could have better managed its media relations, the chapter is organized so as to provide a guide to the challenges the Alliance faced. The chapter first examines how today's media functioning provides challenges to any military endeavor. Second, it analyzes the challenges stemming from the coalition nature of the operation. Finally, it analyzes the challenges stemming from the NATO's policies and organization. It finally concludes with lessons and recommendations for future engagements.

Changing Media Environment Creates New Challenges

Today's media environment provides some enduring challenges for the conduct of military operations. Increased competition, increasing numbers of media actors, continued (if not increased) antagonism toward officialdom, and fast-paced technological developments are only a few of the challenges NATO had to prepare for in its information policy. These changes are likely to continue into the future and are challenges military commanders and political leaders will confront in future operations. This section will review some of these challenges and how they affected NATO during Allied Force.

Facing the Fast-Paced Media Cycle

With the exponential growth of media outlets, all-information networks, round-the-clock operations, and the Internet, the news cycle has expanded to a constant stream of information. Thirty years ago, officials dealt with media deadlines. Newspapers went to print once a day (either in the early afternoon or in the late evening), radio had two major news programs a day, and America's three television network news programs had their major deadlines in the late afternoon for the 6 o'clock evening news. Public Affairs was organized around these deadlines. In those days, a story line could be expected to live at least 24 hours, if not longer. In today's environment, the number of media outlets devoted (partly or entirely) to news has vastly expanded from three television

networks in the seventies to at least nine major broadcast and cable outlets today.⁶ Totally new mediums have emerged, such as the World Wide Web with literally thousands of sites with constantly updated news—both from reputable news organizations (whether broadcast or print or Web based)—create new demands for information and create difficulty for targeting public information efforts. This proliferation of mediums and news vendors have rendered the concept of deadline as virtually meaningless outside very limited contexts. In this environment, the news business is constantly on deadline. Dripping like an open faucet, the media are insatiable consumers of information, placing intense pressures on officials, as Jamie Shae, NATO's chief spokesperson during Allied Force, attested:

One afternoon, I received a respected international correspondent in my office. He asked me for new information. Frankly, I was stunned, I asked him whether he had attended the briefing that had just ended. The correspondent responded that he had attended the briefing, but that was history. He was on at 5 and needed something new.⁷

This environment also places great pressure on reporters and editors to uncover and report information as soon as possible. In this quest, the necessity for filing under deadlines (or on constant deadline) sometimes supersedes the need for verifying stories. The pressures of competition and the need to fill an ever-expanding air time (for television) means that “being first matters more than being right,” and that reporters can go on the air with little to no information provided that they are on the air. In that context, rumors, half-truths, and unchecked information quickly become news. This frequently occurred during Allied Force. Virtually any politician or military official could be assured that comments would get coverage—somewhere. The environment of warfighting often led to unquestioned acceptance of asserted facts that seemed convenient. For example, throughout the war, many journalists repeated Western officials' assertions that Serbian repression in Kosovo had killed tens, if not hundreds, of thousands Kosovar Albanians—as horrific as Serbia's actions might have seemed then or in retrospect, this was not true nor truthful information. In another example, in April 1999, American media wrongly asserted that NATO had softened the conditions for stopping the air war.⁸

Battlefield Transparency or the impact of New Technology

A second challenge for military officers and other officials stems from the threats posed by media access to modern technology. The media now have access to cheap and reliable (essentially) instant communication capabilities. With a portable phone, a reporter can report on events from essentially anywhere in the world. In 1998, even Kosovo was part of the European GSM satellite-based communications system, offering reporters in Pristina timely and reliable communication with the outside world.⁹ In addition, with a digital video camera and a satellite dish, a reporter can provide live footage from anywhere in the world to audiences worldwide in real time.

These technological improvements are starting to blur lines between journalists and spectators. Anyone with a digital hand-held camera and access to the Internet can become a photojournalist under the right conditions. The World Wide Web provides any individual the means to have—literally—world-wide access to describe their views of the situation. Thus, technology further expands the proliferating media spectrum by offering the opportunity to cheaply and, potentially, effectively self-publish with massive, rapid reach.

The increased availability of commercially-available satellite imagery means that the media has access to high-definition satellite pictures—surveillance capabilities better than any government had just decades ago. Governments have little to no control over these firms and the media's access to such material. That form of battlefield transparency can quickly become worrisome to the military, as massive troop movements may be visible to journalists who could report them to the enemy while reporting them to the public. Technology is making it more difficult to hide activity from journalists.

This technological evolution has worried the Pentagon brass for quite some time. Under the chairmanship of General Hugh Shelton, the Joint Chiefs of Staff has sought to protect operational information by increasing the controls of information and tightening guidelines for release of operational information. According to Pentagon's spokesman Kenneth Bacon:

*The leadership is taking a more conservative approach. Both Secretary of Defense William Cohen and Gen. Henry H. Shelton, chairman of the Joint Chiefs of Staff, think we ought to be as stingy as possible in giving out information, which means we have to be restrained with the press.*¹⁰

At the onset of the air war against Yugoslavia, NATO and the Pentagon were worried that too much loose talk might endanger Alliance personnel and threaten operational security (OPSEC). Captain Michael Doubleday, USN, a Pentagon spokesman, explained that:

*We're very concerned about the capability of [Yugoslav President Slobodan] Milosevic to assemble and to aggregate information that could be used to the detriment of our forces.*¹¹

Bacon complained that the Yugoslavs were able to get meaningful tactical information from the media. He argued that they used this information to take actions that threatened NATO's OPSEC or undermined the results of NATO's operations. For example, Bacon argued that live coverage of jets taking-off from NATO bases in Italy gave the Yugoslavs early warning information and helped them understand NATO's operating patterns.¹² In another example, the Pentagon accused the media of allowing Serbia to empty its Interior Ministry before it was struck by a NATO bomb after *The Washington Post* indicated in a story that NATO was going to expand its target list to include various official buildings, including the Interior Ministry.¹³ This last example, however, indicates the complexity of some finger-pointing. In fact, NATO officials (including many Americans) had been talking with many journalists about expanding the target lists in what was seen by many as an attempt to use the media to send a message to (and hopefully intimidate) the Serbs that NATO was not about to end the bombing and that the situation was about to become much worse on the receiving end of NATO air attacks.

The Cycle of Media Punditry

Current trends of media reporting also create some enduring challenges for military commanders. As operations commenced against Yugoslavia, the Pentagon quickly faced a wave of critical media assessments. Critical

assessment refers to the media's increasing tendency not only to report facts, but also to interpret and analyze those facts for the public. In the post-Vietnam/Watergate era, the media's effort to analyze and document the issues of the day is increasingly marked by antagonism and cynicism. The need for antagonism stems from a romanticized vision of journalism where:

...the press is completely independent of government in its quest for news, that it routinely searches out vast amounts of hidden, jealously guarded information, that it is constantly defying persons in high office, that it is the day-in, day-out adversary of the "Establishment" and the equally faithful defender of the People.¹⁴

In this adversarial tradition, journalists treat official claims with suspicion, consider it their duty to find out what is really happening under the surface, and second-guess officials, official statements, and motives.

Examples of this suspicion-filled, antagonistic approach happened throughout the war against Yugoslavia. From the onset of the war, reporters openly questioned NATO's strategy. Reporters and pundits, who had expected (based mainly on comments by officials) a short show of force, questioned whether the strategy was a success. Commentators (both informed and relatively unschooled) immediately voiced concern about whether NATO had the fortitude to maintain its cohesion until victory, considering it likely that the coalition would collapse under the weight of public pressure (especially in Greece and Italy). Reporters criticized NATO for its lack of planning and lack of responsiveness to the refugee situation after Kosovar Albanians began streaming into Macedonia and Albania.

Critical assessments of the war's progress and NATO's strategy were commonplace across the media spectrum. According to research conducted by the Center for Media and Public Affairs, the debate in the nightly news mostly focused on whether the bombing was right or wrong, whether it was achieving its stated goals, and whether ground troops should be sent in. From 24 March to the end of May, 68 percent of all quoted sources opposed the bombing campaign.¹⁵ However, throughout the same period, reporters and pundits alike were convinced that NATO would ultimately prevail (if for no other reason because it could not afford to fail).¹⁶ Overall, 62 percent of all sources quoted thought NATO would prevail. Only during the first week of the bombing,

did a clear majority think President Milosevic might prevail (71 percent). As the war lingered on, reporters and pundits more and more favored NATO as the probable winner. Reporting on whether NATO's strategy was successful was balanced. About 50 percent of those judging the effectiveness of NATO's policy pronounced it a success.¹⁷

Every Story Has Two Sides

For a variety of reasons, today's journalistic ethic in the United States seems to assume that there are at least two sides to every story and that these views deserve a balanced hearing. Thus, in discussing Holocaust deniers, many news outlets will give equal time to renowned scholars and Holocaust survivors, on one side, and Nazis, on the other, as if they have an equal basis to speak authoritatively and as if this issue of fact is open to debate. Thus, in the murkier arena of an ongoing military operation, it should not surprise anyone that journalists view matters of national security and defense as areas with at least two sides to the story. In this context, media organizations feel free to interview the other side, seek and gain access to the battlefield from the opponent, and report on what the opponent side puts forward. This, of course, is complicated by the changing media environment, where us and them is far from as clear a distinction, with the blurring of national boundaries in media organization structures, ownership, and reporting. Steven Erlanger, *The New York Times* correspondent for the Balkans, defined this philosophy as follows:

I think journalism has an obligation to not think that every story must be told from a single side only, which is your own, and I think we also have an obligation, as Western journalists did and do in Iraq also, to listen to the officials of the other side, to try to get their points of view fairly expressed into the paper, into the kind of judgement of public opinion, and part of that is to actually go out and see bomb damage.¹⁸

During the Vietnam War, American reporters took years before finally deciding to report from Hanoi. During the Persian Gulf War, although many news organizations tried to obtain Iraq's authorization to report from Baghdad, Iraq (Saddam Hussein) granted only CNN this privilege. Throughout the war, Peter Arnett regularly fed reports from Baghdad.

(And many Americans considered this Australian reporter a traitor to the United States for this.) During the war against Yugoslavia, many news organizations left reporters in Belgrade to report the Yugoslav point of view.

Broad access (by historical comparison), if not unrestrained, to the Yugoslav side allowed the media to extensively report on the consequences of the bombing on the Yugoslav population. By reporting from Belgrade, the Western media also played into the hands of Milosevic's strategy to undermine the political will of the coalition. Indeed, the Western media became a resounding board for Yugoslavs' claims against NATO's barbaric actions.

Before the war, the Yugoslav authorities agreed to have several Western networks (including CNN, BBC, SkyNews, ABC, French, German, Italian, and Greek televisions) stay and operate from Belgrade in the event of a conflict. This access came at a price and was not—in any major way—unconstrained. Reporters in Belgrade operated under severe restrictions and sometimes under duress. Several reporters were roughed up, interrogated by police, and, in some cases, expelled from Yugoslavia.¹⁹ CNN's star war reporter, Christiane Amanpour, left the country after Milosevic's forces ransacked her hotel room and the indicted war criminal Arkan showed up looking for her.²⁰ Reporters were not free to report on issues of their choice, but taken to media opportunities controlled by the Belgrade authorities. Even under such circumstances, however, Western media felt their presence was valuable to document an essential aspect of the story: the consequences of NATO's air strikes. This coverage was viewed by many NATO and national officials as a key tool for Milosevic having the upper hand in the information war, as he could control access to the ground and—by definition—the best photos. Journalists only got to photograph and report on those situations and images to which Serbian authorities were willing to grant them access. Journalists received invitations virtually on a silver platter when bombs hit hospitals, but events surrounding a destroyed surface-to-air missile (SAM) site were a private affair. Thus, even the most truthful Western reporting from Yugoslavia was at most a partial, and thus distorted, lens on events during the conflict.

European Broadcasting Union (EBU) technical support greatly facilitated Western media coverage from Yugoslavia. The EBU's all-digital Eurovision network made it possible to offer news broadcasters more than 30 channels for news backhaul. Many transmissions were

routed through permanent stations (London, Paris, Washington), but also through temporary production and transmission facilities across the theater.²¹ In addition, the EBU had arranged for reports to be broadcast from the hotel Inter-Continental in Belgrade, a permission Yugoslav authorities suspended on 24 March 1999. However, notwithstanding the revocation of license, EBU was able to continue providing broadcasting opportunities through the Radio-Television Serbia (RTS) (which is a member of the EBU) and through its permanent stations in Budapest and Sofia. EBU multiplied the news broadcasters' opportunities to feed reporting back to their headquarters. In the first 24 hours of Allied Force, EBU handled 1,000 transmissions, and over 10,000 through the first 2 weeks of the campaign.²²

Coalition Challenges

NATO's 19 nations had only a weak consensus leading into the campaign against Yugoslavia.²³ It took a long period of ebb and flow in Serbian aggression, followed by cooperation, then followed by renewed recalcitrance to convince all the nations that some form of military operation had become necessary. NATO nations only reluctantly agreed to use force against Yugoslavia. They were not in agreement about how to conduct the operation, on the amount of force necessary, nor on what constituted legitimate targets. Their only shared view was a hope that Milosevic would back down before any strike would be necessary or after a short, relatively painless (symbolic) bombing campaign.²⁴

From the beginning, the NATO mission in Kosovo was beset by a strategic Catch-22.

NATO political leaders ruled out sending ground troops to Kosovo because they believed their people would not support it. Instead, they backed a limited air campaign that used jets and Navy ships to hit Yugoslav targets with missiles and bombs from three miles up, a strategy designed to limit pilot losses. They believed that such a show of force would within days make Milosevic call off the Serbian paramilitaries and the Yugoslav army troops carrying out the "ethnic cleansing."²⁵

As a result, maintaining strong sentiment among Allied publics in favor of the strategy and continuing the campaign against Milosevic became critical to maintaining the Alliance cohesion. If public support waned, then the commitment of some governments was deemed to be in danger. The perceived frail nature of the coalition made it a matter of utmost importance to maintain strong public sentiment in favor of the intervention.²⁶ On the other hand, the very nature of a coalition created many challenges for NATO in attempting to maintain public support and to speak with a unified voice.

The issue of speaking with a unified voice was a key challenge. Even without the reality that numerous agendas existed within NATO and NATO nations, articulating a single coherent strategic vision appealing to the broad spectrum of relevant audiences would have been a major challenge. These audiences ranged from NATO member nations, other European nations, the world community (official and unofficial), the Kosovar Albanians, to the Serbians (Milosevic, the military, the public). These audiences (and, of course, each of the listed groups can be broken up in almost endless ways to create a confusing array of target audiences) had varying (if not diverging) interpretations of events, varying interpretations as to the principles in question, and varying degrees of tolerance for the use of force and for collateral damage.

Within the challenge of speaking with a common voice came the challenge of accommodating differing national practices and doctrines for information release and dealing with the media. Every NATO nation wanted to handle information and information release as it saw fit to accommodate its national issues. Within the coalition, key nations included France, Germany, the United Kingdom, and the United States. Each of these governments (and, perhaps, more importantly, key actors in these governments) had greatly different views as to how to handle release of information and dealing with the media. The contrast between the United States and the United Kingdom well illustrates these differences.

As always, U.S. government media activity seemed mainly focused on domestic political issues—despite the fact that the nation was at war. Numerous statements, leaks, and background comments seemed focused on internal political issues rather than their possible international implications. President Clinton's ruling out the use of ground forces at the outset of Allied Force is the most prominent example

of this tendency to focus on internal factors seemingly oblivious to their external impact.²⁷

The UK government, on the other hand, mainly spoke on the record and the key comments seemed designed to influence its allies about campaign strategy and to convince Milosevic that NATO did have the resolve to see the campaign through to victory. Prime Minister Tony Blair's public advocacy of the use of ground forces and reporting on the preparations to mobilize 50,000 members of the Territorial Army for a potential ground war are a good example of the UK's approach. While these comments were surely designed to communicate to the British public about the seriousness of the endeavor, they were more assuredly aimed at allies (to convince others that a ground war might be necessary) and Milosevic (to show resolve and, hopefully, push him toward capitulation).

Official policy and structure for the release of information also differed across the nations. Three cases illustrate the difficulties stemming from this.

The British Ministry of Defence (MoD) did not follow SACEUR's guidelines to restrict comments to its own national forces' participation and actions—without providing too much detail. The British MoD allowed release of more information on its operations than any other nation. It encouraged UK subordinate commanders to join national press conferences (via video conference) to answer media queries. The British allowed a fair amount of coverage of their units in theater and engaged in operations. The British approach created tensions with the United States and some other NATO nations as reporters asked the Pentagon and NATO for similar access.²⁸

Throughout the war, many different nations, organizations, and units issued different Public Affairs Guidelines (PAGs).²⁹ These PAGs were not always consistent with each other, creating confusion at subordinate command levels as to what the official line was. According to a U.S. Air Force, Europe, (USAFE) after-action report, these PAGs sometimes offered contradictory guidelines to public affairs officers (PAOs) in the field. In some cases, units received PAGs from organizations not in their chain of command. The confusion was sometimes compounded by the fact that units in the NATO chain of command sometimes followed national rather than NATO guidelines.

Different nations had different concepts for information release and the role of public information officers. Traditionally, U.S. public affairs

officers consider their mission to be to “release complete, accurate, and timely information to the public and the media.” Keeping this standard is the key to credibility. While not trying to spread disinformation, the PAO’s job is to present, as cogently as possible, the military’s point of view and attempt to have this view reflected in media reporting. Not all nations’ militaries view public information in this light. Some see little distinction between public information and psychological operations, some see public information as a synonym with advertising (get out a good story no matter the truth, spin), while others view a public information officer’s responsibility as simply keeping the media out of the commander’s hair.³⁰ Tensions arose at NATO headquarters over which view of public information should prevail. As reports that the Yugoslav army in Kosovo was experiencing morale problems surfaced, some nations argued that NATO should use the spokesman to emphasize the problems, to inflate the consequences of the attacks in Kosovo to further deepen the opponent’s morale problems. A majority of the participants, however, argued that this would be an ill-advised approach. They argued that spreading false information would ultimately backfire. As the Yugoslavs could probably be able to assess the amount of damage NATO was actually causing, they would be able to take advantage of inaccurate NATO claims. The latter view was upheld.

Maintaining unity through the conflict was not easy. Again, NATO had only a weak consensus for resorting to the use of force against Yugoslavia and this consensus weakened as it became clear that a few days of strikes were not sufficient to force Milosevic to surrender. As the conflict dragged on longer than expected, U.S. officials began to engage in a blame game. A variety of American officials (civilian and military) anonymously accused the Europeans of foot-dragging in decisionmaking in an effort to explain why the campaign was not yielding the expected results and to deflect blame away from the Administration in the internal U.S. political dynamic. By mid-April, several articles in *The Washington Post* and *The New York Times* appeared blaming the Europeans for exerting too much caution, refusing to allow the use of ground troops, restricting the number of targets, and limiting their assets in support of the campaign. These ‘sources’ rarely discussed the internal U.S. military and government processes that created similar drag on the campaign strategy and on prosecuting the air campaign. As reporters demanded accountability

for the slow progress of the war, U.S. officials showed little resistance to the urge to point fingers and allocate blame on the Europeans, while diminishing the responsibilities of the U.S. government.³¹

Challenges Within the Military to Effective Public Information

The ultimate measure of merit (MoM) for any warfighter must be performance in conflict. Despite any problems, the overall effectiveness of NATO's public information must be judged positively—NATO won and the general world-wide belief was and remains that NATO was mainly right during its conflict over Kosovo. At no point during the campaign did Alliance public opinion (with the principal exception of Greece) undermine the military operation, giving governments breathing room to continue (albeit with problems) prosecuting combat operations until NATO decided President Milosevic had complied with its demands.

A great deal of the success, however, must be laid on the opponent's lap. Milosevic's massive expulsion of ethnic Albanians strengthened the resolve of Western publics. Meanwhile, the public massively supported the proposition that Milosevic (not NATO) was responsible for the expulsion of ethnic Albanians. U.S. media (network) references to President Milosevic were overwhelmingly negative, while their references to President Clinton were overwhelmingly positive.

Although there was a lot of discussion about the air strikes and the strategy, the media and the public both believed that, ultimately, NATO would prevail.³²

While NATO won the conflict and won in the information arena, this victory occurred despite a range of problems and at a cost. The following paragraphs examine some of the weaknesses and shortcomings of NATO's information policy. While these shortcomings did not cause NATO to lose the media war to Milosevic, they clearly affected NATO's ability to convey its message in an accurate and timely manner. In a different environment and with a more skillful opponent, they could lead to failure. Addressing these shortcomings could help avoid such a catastrophic failure in the future.

NATO's Organization

The PI organization, much like the rest of NATO's operation, was caught off guard by the extended bombing campaign, nor were they prepared for the media frenzy that accompanies major military operations in today's world. Anticipating a short and limited operation (and, until the last moment, uncertain whether it would even occur), the organization was not augmented prior to the operation. In addition, due to somewhat modifying the NATO process for public information, the understaffed PI organization was poorly prepared for discussing actual military operations (rather than policy issues).

The following were the key NATO PI nodes at the start of Allied Force:

SHAPE: SHAPE PI, which usually handles media relations for the military headquarters, played no role in the information policy for Kosovo and was tasked with conducting PI for all non-Kosovo matters.³³ At SHAPE headquarters, an Information Operations (IO) group under the auspices of Deputy Supreme Allied Commander, Europe (DSACEUR), the deputy Operations officer, General David Wilby, UK, chaired the IO cell. The cell consisted of operations officers (CJ-3), intelligence officers (CJ-2), PSYOP officers, and the military spokesman. The IO cell was tasked with issuing daily guidelines and supervising the daily information activities. The presence of the PSYOP and PI officers enabled SHAPE to unify the Alliance's messages. Again, however, the SHAPE PI had no direct role in dealing with the media on Kosovo operations.

NATO Headquarters: At NATO headquarters, a five-person PI cell was tasked with information dissemination, handling daily press briefings, maintaining the NATO Web page, and answering media queries on a round-the-clock basis. The NATO PI organization is civilian and focused on policy issues surrounding the North Atlantic Council (NAC), which governs NATO. They do not normally deal with the details of military operations and do not have a strong link into (nor direct authority over) the SHAPE PI staff, nor do they have a direct link into the SHAPE operations cell.

Other NATO and national commands: While virtually all major commands have public information (or public affairs) staffs, NATO ordered commands to restrict their dealings with reporters, attempting to centralize the release of information.

The initial organization did not enable NATO PI to provide the media with timely and accurate information. Shae and his staff worked around the clock to piece together the relevant operational picture to answer reporters' questions as best as they could and prepare for the daily briefing. However, the peacetime staff of five was seriously overworked to deal with the 600-strong press corps crowding the NATO headquarters.³⁴

The staffing problem was compounded by a lack of adequate relationship between NATO PI and SHAPE Ops. NATO PI staff was not allowed in operational meetings (the VTCs between various commands) nor in the SHAPE IO group. As a result, Shae found himself:

*...before a gigantic jigsaw puzzle. Every day, I had to work hard to put the pieces together. I needed to act as a journalist to reconstruct the story as best I could.*³⁵

The organization marginalized Shae, putting him in an impossible situation. He was out of the loop, unaware of major operational developments, and too remote from the commander's thinking to be able to effectively manage the massive media presence to shape NATO's public image during a combat operation.

The United Kingdom drove a change in the situation. In mid-April, UK Prime Minister Tony Blair asked NATO Secretary General Javier Solana to make changes in the public information arena to create a more effective approach. This led to an augmentation of the PI staff with over forty additional staff (mainly UK and U.S. personnel). The additional staff also came with more authority to have access to operational information and NATO commands. The reorganization enhanced the status of the PI operation and enabled the PI to work more closely and more effectively with the operational staff. As Jamie Shae admitted, this reorganization and augmentation greatly improved his ability to deal with the media and speeded his ability to release information. These improvements allowed NATO to better satisfy the media's quest for information and enhanced NATO's credibility with journalists (and, by extension, the public at large).

NATO Headquarters established a Media Operations Center to improve the circulation of information between the operational side and the PI. The MOC consisted of a twenty person team (again, mainly American and British). NATO formed the MOC to strengthen ties between NATO

HQ PI and the SHAPE operations cell to get operational details in a more complete and more rapid fashion into the hands of the PI staff.

NATO PI improved its liaison relationship with the key NATO capitals. In the original set-up, Shae's team had neither the time nor the resources to manage sustained relations with the major capitals involved in the operation. The MOC had national liaisons built into the concept. Moreover, the influx of new personnel allowed NATO PI to prepare and handle daily teleconferences which included the key spokesmen (NATO, U.S., UK, French, German).

The CAOC formed a crisis center in Vincenza to handle information relating to collateral damage incidents.

NATO's Concept of Operation

To ensure effective dissemination of the Alliance's message, NATO chose a pro-active policy whereby NATO and (some) Alliance spokesmen would brief the media regularly and be available to answer their queries around the clock (or, to use the current buzzword, on a 24/7 basis).³⁶ On a daily basis, reporters had access to NATO's version of events from 9 a.m. to the end of a 9 p.m. briefing (Brussels time) (see Table 1). In retrospect, Shae commented on the media saturation strategy:

The one thing we did well in the Kosovo crisis was to occupy the media space. We created a situation where nobody in the world who was a TV watcher could escape the NATO message.³⁷

The strategy suited the cable news format. With the daily briefings, NATO and the Alliance's members provided cable news television with a series of (cheap) newsworthy daily shows that attracted audiences. Indeed, several all-news cable outlets, such as CNN, C-SPAN, MSNBC, and Sky-News carried one or all of the briefings every day. The Western point of view was therefore widely disseminated throughout the day. Evening news programs, newspapers, and newsmagazines regularly referred to material released during these briefings. The constant rollover of official briefings certainly helped the Alliance set the media agenda for the day and allowed it to respond (multiple times and in numerous ways) to criticisms or questions raised by reporters.

Time (Bruxelles)	Location	Audience
9:00	Background briefing, NATO HQ	Europe, Asia, Middle East
11:00	British MoD	Europe, Middle East
15:00	Briefing at NATO HQ	Europe, Americas, Middle East
19:00	State Department	Europe, Americas
20:00	Pentagon	Americas, Europe
21:00	White House	Americas, Europe, Asia

Table 1: NATO's Media Saturation Strategy

To fill the media spectrum, NATO and the capitals resorted to a mix of philosophical rhetoric and operational information about the air campaign. As SACEUR was wary that release of operational data could jeopardize operational security, he initially insisted on tight guidelines for information release whereby “specific information on friendly force troop movements, tactical deployments, and dispositions could jeopardize operations and endanger lives.”³⁸ In addition, to protect pilots (and their families) from retaliatory actions, NATO asked reporters not to identify military personnel by name or photograph them. Finally, SACEUR gagged NATO subordinate commanders, ordering them to restrict their interactions with the media. For the first 3 weeks of operations, NATO and the Pentagon contented themselves with the vaguest statements about sortie numbers and their effects on the Yugoslav military, maintaining an optimistic outlook.³⁹

As the war continued, however, both NATO and SACEUR relaxed some of the restrictions, increasing transparency and allowing more information about the targeting process and its results. SACEUR explained that

...now that the Yugoslav understand the pattern of our attacks, it does not make much sense to hold such information.

As a result, the press was increasingly filled with more detailed discussions about the prosecution of the war. To mark the shift in strategy, policy and operational flag officers were added to the daily Pentagon briefing, so as to present a more complete operational picture and release more complete, accurate, and timely information to the public. Such efforts paid off. Jamie Shae remarked that after the mid-April reorganization, he was able to give out six times as much information as at the beginning of the war by 9 a.m.⁴⁰

On the other hand, NATO used every opportunity to press virulent anti-Milosevic rhetoric, demonizing the dictator and faulting his policies. As the conflict lingered on seemingly without end, NATO stepped up its rhetoric, unveiled new evidence, and offered new testimony of Milosevic's brutal and misguided policies in Kosovo. For example, Western officials likened Milosevic's policies to the Third Reich's.⁴¹ When information supported attacks on Milosevic or his policies, restrictions on releasing specific types of information were applied far less stringently.⁴²

A Flawed PI Concept of Operation?

NATO's public information concept of operations had a number of flaws. In fact, three problems quickly emerged.

First, reporters immediately criticized the NATO restrictions on the release of information.⁴³ Reporters bitterly criticized NATO and the Pentagon for releasing too little information, avoiding reporters' questions, and keeping to general, optimistic, and vague statements. As *The Baltimore Sun's* Ellen Gamerman wrote:

*The crisis in Kosovo is described by NATO officials with gung-ho sound bites, blurry aerial videotapes of bomb drops (with the sounds of pilots in combat politely left out) and occasional aerial photos of bombed-out targets. In Washington, daily briefings by White House spokesman Joe Lockhart and Pentagon spokesman Kenneth H. Bacon occasionally release a bit of new information but they have routinely allowed the briefings to remain vague.*⁴⁴

Others felt that NATO was unresponsive to questions.⁴⁵ Many reporters felt NATO lied in attempts to make a failed operation look like a success. News organizations protested the information black-out. In early April 1999, seven news organizations sent a letter to Secretary Cohen denouncing the restrictions and urging him to relax the rules so they could better inform the public.⁴⁶ In reaction to this, Ken Bacon convened a meeting with the news organizations and agreed to relax some of the rules. However, the bulk of the restrictions on operational information remained. The constant stream of anti-Milosevic's demonization led

many reporters to equate Milosevic's and NATO's propaganda machines. Criticisms subdued as NATO became more forthcoming on the shortcomings of its campaign and began to release more information after several weeks of military action.

Second, NATO seriously eroded its credibility when it released false information, unverified rumors, and exaggerated speculations about what was happening inside Kosovo. Jamie Shae has maintained that he paid extra attention to releasing only factually correct information and argued that he discarded many rumors and allegations that, he felt, were not substantiated.⁴⁷ However, despite Shae's carefulness, in its eagerness to convince the media, NATO did not always handle information with the care it required and, on several occasions, released false information.

On 29 March, NATO announced that Yugoslavia had assassinated Fehmi Agani (advisor to Ibrahim Rugova) and five other militants. This was not true and two days later, NATO had to retract its statement.⁴⁸

In their zeal to demonize Milosevic's regime, several NATO leaders, including Prime Minister Tony Blair, German Chancellor Gerhard Schroeder, and the U.S. special envoy for war crimes, all publicly claimed that Milosevic's forces had killed tens (if not hundreds) of thousands of Kosovar Albanians. The figures turned out to be largely exaggerated. As of May 2000, the ICTY had exhumed 2,108 corpses from various mass graves across Kosovo.

Several times, to avoid taking responsibility for collateral damage caused by its own forces, NATO released false and unsubstantiated information. For example, when two F-16s mistakenly hit two civilian convoys near Djakovica (14 April 1999), SACEUR first accused the Serbs. Later on, after NATO killed 80 Albanian refugees in the Korisa command barracks, the Alliance initially blamed the Serbs.

Third, with some information releases, NATO may have eroded its operational capabilities and given Milosevic substantial advantage or affected his decisionmaking to the detriment of NATO objectives. Catering to various audiences (national audiences, Serbian forces, Serbian leadership), the allies had some difficulties reconciling how to speak with a single consistent message. As a result, NATO may have given the Yugoslavs equivocal signals as to its intentions, capabilities, and resolve—this mixed message might have extended the campaign's

duration. For example, at the opening of the war, President Clinton announced he had no intention to send ground troops into harm's way. The President was catering to the American audience who did not support losing too many lives for Kosovo. Meanwhile, the statement may have led Milosevic to conclude that NATO's effort would simply be half-hearted and encouraged him to adopt a posture of waiting out the Alliance.⁴⁹

NATO's public announcements of its intended targets, at times, allowed Milosevic to manipulate the situation to his benefit. After NATO announced it was ready to strike the radio-television station, the Yugoslav authorities ordered a few workers into the targeted building. These workers were among the casualties of the bombing.⁵⁰

Public announcements of disagreements between Alliance members—in particular on the need for planning a ground operation or on the legitimacy of specific targets—may have enticed Milosevic into believing that his strategy of division may work. Milosevic likely entered the campaign learning a lesson from Saddam Hussein's experience with Operation Desert Fox in 1998—that the most the Western Alliance could mount would be a short, relatively painless bombing exercise that would leave him in a stronger position internally and externally after the dust settled. The mixed messages may have kept Milosevic holding onto this image and kept him from entertaining serious peace discussions much longer than if NATO had been able to speak with a truly unified voice.

Countering Serbian Propaganda

Much of the criticism addressed by officials to the NATO's PI structure focused on its perceived inability to effectively counter Milosevic's propaganda and efforts to destabilize the coalition. Milosevic's regime propaganda mostly consisted of describing Kosovo as an internal affair and denouncing NATO's barbaric aggression against Yugoslavia.

At the start, NATO and its nations were curiously ill equipped to deal with Milosevic's propaganda machine. Early in the war, and with a staff of five, NATO PI did not have sufficient resources to monitor the Yugoslav media. In addition, the Alliance was short of staff with local language capabilities. Not until mid-April 1999, with the reorganization of NATO PI, did NATO have qualified personnel tasked with monitoring the Yugoslav media. By the same token, NATO's Internet Web site was

not translated into Serbo-Croat due to a lack of resources.⁵¹ Even without Serbo-Croat language material, NATO Web sites received frequent hits from within Yugoslavia—though how effective or far-reaching English (or French) messages were is unclear.

NATO also had difficulties reacting to Yugoslavia's exploitation of collateral damage. The media devoted considerable attention to the collateral damage issue. Although only 20 bombs went astray with deadly consequences (out of a total of 23,000 ordnance dropped), stories about collateral damage made up to 23 percent of war coverage on the three networks. (Table 2 summarizes CNN coverage to some collateral-damage incidents.) Again, it was the Serbs who controlled on the ground access, thus it was far easier to get film footage of a bomb that struck a home than one that hit a command bunker.

Date	Incident	# of stories
7 May 1999	Chinese Embassy	212
14 April 1999	Djakovica	60
13 May 1999	Korisa Command Post	31
12 April 1999	Gredlica	25
23 April 1999	RTS Station	19
5 April 1999	Aleksina	16
1 May 1999	Luzanne Bridge	13
27 April 1999	Surdulica	12

Table 2: CNN Coverage of Collateral Damage

Collateral damage coverage allowed Milosevic to set the agenda. Yugoslavs controlled the scene of the incidents and they quickly brought reporters to sites that told a good Yugoslav story (such as, in a non-collateral damage story, the crash site of the shot-down F-117). The Yugoslav authorities would disseminate initial information about these incidents, creating the first impression, and let reporters turn to NATO for accountability. However, NATO's strategy in dealing with instances of collateral damage did not effectively counter Milosevic's efforts. A General, speaking on condition of anonymity, confided to French journalist Serge Halimi that: "All we had to do was announce that we were looking into the incident and release the information two weeks later when nobody cared anymore."⁵² But that was not NATO's approach to these incidents.

In fact, NATO responded in an ill-advised and inadequate way to collateral damage incidents. NATO's approach only perpetuated the stories and gave Belgrade more credibility. In the case of the Djakovica incident, NATO first denied any involvement (accusing the Yugoslavs). NATO then asserted that Allied pilots had only bombed military vehicles. The next release was an acknowledgement that one F-16 might have bombed a civilian convoy. This was followed by a press conference focused on the tape recording of the voice of the relevant F-16 pilot talking with the CAOC to illustrate the difficulties of identifying targets, and later by an acknowledgement that the voice recording had nothing to do with the incident. It took 5 days for the Alliance to finally acknowledge all the facts that had first been released in a matter of hours by Belgrade: that two F-16 had struck two civilian convoys North of Djakovica, killing a number of civilian refugees. In the case of the Korisa command post in late May 1999, NATO again first refused to acknowledge that any civilians had been killed. It took NATO 2 days to acknowledge the facts.

By delaying information, making wild (and unfounded) accusations and disseminating false information, NATO damaged its credibility. This prolonged the story for as many days as it took NATO to finally come clean on the facts. NATO failures gave some credibility to the accuracy of Serbian reporting. A more effective approach would have been to readily acknowledge mistakes, explain why they happened, and move forward to the next issue. As such, the story would have died a natural death much faster. A case in point is the bombing of the Chinese Embassy. It took only 2 days for the U.S. government to find out how the mistake happened. As a result, the story about sorting out the facts died very quickly and NATO was praised for being forthcoming.

Concluding Remarks

Astonishingly enough, as it prepared to go to war against another nation in a difficult context, the Alliance underestimated and did not adequately prepare for fighting the media war.

Erroneous assumptions (such as the duration of the campaign) and inadequate planning handicapped NATO's public information effort. As a result, the NATO public information office was understaffed and overworked and could not effectively fulfill its mission during the initial period of Allied Force.

Public Information was not closely linked to operations cells at the beginning of Allied Force. Long experience has shown that PI cannot be effective in the context of modern military operations without a close association and understanding of operations. As the media is part of the modern battlespace, commanders must integrate PI into battle plan, much like any other weapon. Missing or deficient links with operations leave PI officials ill informed, and therefore ill equipped to brief the media, as occurred with NATO in Allied Force's initial weeks.

Restrictive information policy tarnished NATO's credibility and provided for a confused and unclear picture of what was happening, fueling debate and controversy across the world.

NATO was ill prepared to handle the civilian casualties/damages issues. Journalists frequently found NATO unable or unwilling to quickly admit to the truth, leaving Milosevic time to exploit further collateral damage incidents to undermine NATO and support his agenda.

Having multiple briefings across the Alliance (principally Brussels, London, Washington) enabled the Alliance to dominate the media space throughout the day and to speak more effectively to different audiences. However, this also opened the door for mixed messages and required significant resources for coordination that, again, were not available at the outset of operations.

As called forth above, the Allied Force experience suggests a number of lessons identified for NATO and other coalitions for public information in future operations.⁵³ We can only hope that NATO and its constituent nations adopt these PI lessons so that an effective PI policy can be a force multiplier rather than a means of simply managing crises that occur during operations. As Admiral Ellis concluded:

*Properly executed IO could have halved the length of the campaign.*⁵⁴

Public information is a critical component of the soft-side of information operations and deserves serious focus before—rather than after—NATO's next military operation.

⁵³See for example, Jamie Shae, *The Kosovo Crisis and the Media: Reflections of a NATO Spokesman*, Address to the Summer Forum on Kosovo organized by

the Atlantic Council of the United Kingdom and the Trades Union Committee for European and Transatlantic Understanding, Reform Club, London, 15 July 1999. See also, Alastair Campbell, "Communications Lessons for NATO, the Military and Media," *RUSI Journal*, August 1999, 144/4, 31-36.

²As quoted in Bob Shacochis, "Pens and Swords: A Positive Dynamic for the U.S. Media and Military," *The Harvard International Review*, Winter-Spring 2000, p. 26.

³Secretary Cohen and General Shelton, USA, *Joint Statement on the Kosovo After-Action Report*, presented before the Senate Armed Services Committee, 14 October 1999. Available at www.defenselink.mil:80/news/Oct1999/b10141999_bt478-99.html

⁴Admiral James Ellis, U.S. Navy, Commander-in-Chief, Southern Europe (NATO CINCSOUTH) and Commander-in-Chief, U.S. Navy, Europe (CINCUSNAVEUR), "A View From the Top," briefing, 1999.

⁵Ministère de la Défense, *Les enseignements du Kosovo: Analyses et références*, Paris, Délégation à la Communication de la Défense (DICOD), novembre 1999, p 38. Available at www.defense.gouv.fr

⁶In the early seventies, only three networks existed: ABC, NBC, and CBS as well as a public network, PBS. Today, these networks are completed with three CNN outlets (CNN, CNN International, and CNN fn), three C-SPAN networks, MSNBC, CNBC, Fox news channel. This, of course, does not even consider local stations, radio stations, nor international networks and programming with reach into the United States.

⁷Jamie Shae, Presentation to the United States Institute of Peace Seminar on "The Media and NATO in Kosovo: Partners or Partisans," Washington DC, 4 April 2000.

⁸Steven Brill, "War Gets the Monica Treatment," *Brill's Content*, 2/6, August 1999, p 101-103.

⁹The GSM system was the only reliable communication system in the country. Otherwise, communications would have to go through the state system, notoriously unreliable, but also under state surveillance.

¹⁰Associated Press, "On the Info Front, Military Plays It Conservative," *The Washington Times*, 12 April 1999, p 11.

¹¹Ellen Gamerman, "Information About War Is Tightly Controlled. Reporters have to accept Pentagon's slant on action," *The Baltimore Sun*, 7 April 1999.

¹²There is anecdotal evidence that the Yugoslav quickly learned the pattern of NATO's bombing runs, as many officers have acknowledged, publicly or privately. Whether the Yugoslav learned this watching CNN or with their own spies standing at the outskirts of the bases remains to be seen.

¹³Thomas Lippman and Dana Priest, "NATO Agrees to Target Belgrade," *The Washington Post*, 31 March 1999, p A1. Several reporters disagree, arguing the expanded list of target was common knowledge.

¹⁴Paul H. Weaver, "The new journalism and the old—Thoughts After Watergate," *The Public Interest*, Spring 1974, p 74.

¹⁵Center for Media and Public Affairs, "Crisis in Kosovo: TV News Coverage of the NATO Strikes on Yugoslavia," *Media Monitor*, XIII/2, May-June 1999.

¹⁶As expressed by Brookings Institution specialist Ivo Daalder. See Ivo H. Daalder and Michael E. O'Hanlon, *Winning Ugly: NATO's War to Save Kosovo*, Washington, DC, The Brookings Institution, 2000.

¹⁷Center for Media and Public Affairs, "Crisis in Kosovo: TV News Coverage of the NATO Strikes on Yugoslavia," *Media Monitor*, XIII/2, May-June 1999.

¹⁸*New York Times* correspondent Steven Erlanger on *CNN Reliable Source*, 3 April 1999.

¹⁹For example, CNN lost about \$1 million in equipment burned, destroyed or confiscated during the Kosovo crisis. Peter Johnson and Gary Levin, "Cost of War," *USA Today*, 29 April 1999, p 3D. Many reporters have been threatened or abused by Yugoslav authorities. Italian journalist Lucia Annunziata and French TV reporter Memona Hinterman were both (among others) roughed up and expelled by Belgrade authorities. See "Abuse of reporter outrages Italians," *European Stars and Stripes*, 18 April 1999, p 7.

²⁰CNN refused to do any coverage of Amanpour's circumstances. Eason Jordan, CNN's executive in charge of global news-gathering, explained that "the story is not what happens to CNN journalists. The story is the bombing of Serbia," in Charles Lane, "Air War Serbia Schackles CNN," *The New Republic*, 10 May 1999. However, other news organizations made Serbia's media relations part of the story. Both CBS and ABC interviewed their own correspondents after they were detained, interrogated, and expelled from Yugoslavia on 25 March. French television also broadcast several segments on the same theme.

²¹These included facilities in Aviano, Italy (near the Combined Air Operations Center (CAOC) and a principal NATO airbase for the operation); NATO Headquarters in Brussels, Belgium; Skopje, Macedonia (near the border with Serbia (Kosovo area) and with NATO forces in Macedonia); and Tirana, Albania (with NATO and national relief efforts and the U.S. Task Force Hawk).

²²That's more coverage on day one than on the first day of the ground war during the Gulf War or than following Princess Diana's death in 1997.

²³A wide range of works have come out looking at the path to the war. The following three works represent a valuable (and hopefully representative) spectrum of Western views of events: Tim Judah, *Kosovo: War and Revenge*, New Haven and London, Yale University Press, 2000; See also Ivo H. Daalder and Michael E. O'Hanlon, *Winning Ugly: NATO's War to Save Kosovo*, op.cit; and, Barry R. Posen, "The War for Kosovo: Serbia's Political-Military Strategy," *International Security*, vol. 24, no. 4, Spring 2000, pages 39-84.

²⁴A common estimate at NATO headquarters was that the political consensus for continuing the strikes would not last more than 4 to 6 days. A memo circulated between the British and German NATO representatives on 20 March 1999, reflected that sentiment: "Political will to see through NATO's threat of military action is not guaranteed if it does not achieve results within 4 to 6 days," quoted in Tim Judah, *Kosovo: War and Revenge*, op.cit., p. 235.

²⁵Dana Priest, "Risk and Restraint: Why the Apaches never flew in Kosovo," *The Washington Post*, 29 December 1999. Article can be found at: <http://propl.org/nucnews/9912nn/991229nn.htm> This is well discussed in: Ivo H. Daalder and Michael E. O'Hanlon, *Winning Ugly: NATO's War to Save Kosovo*, op. cit.

²⁶The nature of NATO decisionmaking, however, did ease this pressure somewhat. The key factor in NATO decisionmaking is unanimity. A unanimous vote was required to start the bombing campaign. In theory, one might have been required to stop it. Thus, as long as no clear-cut decision was required at the North Atlantic Council (NAC) related to continuing the bombing, no single nation (other than, perhaps, the United States) could easily end the bombing. While more than one NATO government was troubled by the course the campaign took, not even the Greek government (with the Greek population the most pro-Serbian of any NATO population) seems to have seriously tried to end the campaign without some degree of NATO victory in hand.

²⁷This represents a great change in the media environment. Several decades ago, politicians could speak with separate messages to overseas and domestic audiences without difficulty. Today, with the instant and worldwide reach of the media (such as CNN), American politicians (and other significant individuals, such as Pentagon briefers amid a conflict) do not have the luxury (ability) to distinguish between audiences in this way. Thus, a message meant mainly to forestall internal criticism of military action also hit foreign audiences (such as Milosevic) who may not have been an intended target.

²⁸See for example, Department of Defense, Briefing, 25 March, 26 March, 27 March, 29 March 1999. This situation is a real contrast to earlier NATO and coalition operations involving the United States and the United Kingdom. It is difficult to think of an operation prior to Allied Force involving UK and U.S. forces in which the situation was not reversed, with the United States releasing more information. The U.S. government (especially the Department of Defense) adopted a more restrictive policy regarding information release during military operations through the end of the 1990s while the United Kingdom seems to have decided that media reporting is a key battlefield and that effectively presenting and releasing information is a key tool in winning that battle.

²⁹Public Affairs Guidelines are internal instructions detailing talking points for public affairs officers to use with the media.

³⁰Not that there are not U.S. officers who view public affairs in this light as well. For a discussion of some national differences during NATO's initial period on the ground in Bosnia, see: Pascale Combelles Siegel, *Target Bosnia: Integrating Information Activities in Peace Operations: The NATO-led Operations in Bosnia-Herzegovina: December 1995-1997*, Washington, DC, National Defense University Press, 1998.

³¹That process lasted after the war. For example, in a long article on the deployment of Apaches (Task Force Hawk) in support of the air war, *The Washington Post* repeated claims from unknown U.S. officials that France and Italy significantly delayed the deployment. (Dana Priest, "Risk and Restraint: Why the Apaches never flew in Kosovo," *The Washington Post*, 29 December 1999. The article can be found at: <http://prop1.org/nucnews/9912nn/991229nn.htm> Priest does not seem to have interviewed either French or Italian officials. Having spoken to numerous U.S. and allied personnel involved with Albania operations, the claimed problems caused by allies were exaggerated as part of a process within the U.S. system to avoid blame for Task Force Hawk's troubled deployment.

³²This is discussed in further detail in Pascale Combelles Siegel, *Did NATO win the media and does it matter for C2 research?* Presentation for the CCRTS symposium, Monterey, June 2000 (available via: www.dodccrp.org). For a discussion of the air strike strategy, see, for example: Daniel Byman and Matthew C. Waxman, "Kosovo and the Great Air Power Debate," *International Security*, vol. 24, no. 4, Spring 2000, pages 5-38.

³³The reasons for excluding SHAPE PI from the Kosovo PI operation about Kosovo remain unclear.

³⁴Alastair Campbell, Prime Minister Blair's media guru, describes the situation: "When I saw the NATO press service, I was amazed that Jamie was still alive. He was doing his own scripts, fixing his own interviews, attending key meetings, handling every enquiry that came his way, large and small. He was the front man for the whole campaign, yet was expected to do his job without adequate support," Alastair Campbell, Prime Minister Blair's press secretary, recalled NATO's press operation in the following terms: in "Communications

Lessons for NATO, the Military and the Media,” *RUSI Journal*, vol 144, n° 4, August 1999, p 32.

³⁵Jamie Shae, presentation to the United States Institute of Peace, Washington, DC, 4 April 2000.

³⁶NATO headquarters, the British Ministry of Defense, the Pentagon, the State Department, and the White House briefed reporters on a daily basis. Only the White House usually does. Other coalition members (such as France) chose a more subdued approach, meeting with reporters on a as-needed basis and holding only occasional press conferences.

³⁷Dr. Jamie Shae as cited in Maj. Gary Pounder, USAF, “Opportunity Lost: Public Affairs, Information Operations, and the Air War against Serbia,” *Aerospace Power Journal*, Summer 2000, p 67.

³⁸Maj. Gary Pounder, USAF, Op. Cit., p 66. As a result, such information as the number of aircraft involved in missions, types of ordnance dropped, selected targets, weather conditions, rough estimate of damage inflicted to the Yugoslav forces and infrastructure were routinely withheld from the press.

³⁹Within the United States, it seems clear that this limited release of information represents a clear change of policy and continues to affect public understanding of Allied Force. As of this writing, almost 2 years after Allied Force, the quality and extent of publicly released information is sparse and poor compared to the same types of information released during and following Operation Desert Storm. Compare the Department of Defense’s official reports following the two operations and this clear change becomes clear. Interestingly enough, this seems to be the reverse with at least a few U.S. allies, as both the UK and French after-action and lessons reports from the campaign against Serbia are more extensive than those release after the war with Iraq.

⁴⁰Jamie Shae, presentation to the United States Institute of Peace, 4 April 1999.

⁴¹This might not have been necessary. Broadcast footage of Yugoslav authorities (including military personnel) showing refugees aboard trains (including cattle cars) in Pristina was enough to remind Europeans of their darkest moment.

⁴²For example, in early April, German officials indicated they had evidence that Milosevic had planned the mass expulsion of Kosovo Albanians (known as Plan Horsehoe) and detailed the evidence that supported their claim. Later, NATO documented mass graves with satellite pictures.

⁴³A good summary of reporters’ discontent with NATO’s regulations appeared in: James Kitfield, “Command and Control the Messenger: The media feels used and abused after Pentagon manipulations of information during the war,” *National Journal*, 11 September 1999, pp 25-46.

⁴⁴Ellen Gamerman, “Information About War Is Tightly Controlled,” *The Baltimore Sun*, 7 April 1999.

⁴⁵For example, Margaret Evans (Canada Broadcasting Company): “I’d like to have my questions answered, period. I’m tired of straightforward questions being answered by a stream of rhetoric.” For a review of the media criticisms, see James Kitfield, “Command and Control the Messenger: The media feels used and abused after Pentagon manipulations of information during the Kosovo war,” *The National Journal*, 11 September 1999, p. 25-46.

⁴⁶The following organizations signed the letter of protest to Secretary Cohen: *The New York Times*, *The Los Angeles Times*, *The Wall Street Journal*, NBC News, CNN and the Associated Press. For more information, see Felicity Barringer, “Editors Seek More Information On The Air War,” *The New York Times*, 16 April 1999.

⁴⁷Jamie Shae, comments at the United States Institute of Peace, 4 April 1999.

⁴⁸Mr. Agani was executed three weeks later, in unclear circumstances. Others, such as Baton Haxhiu, editor of *Koha Ditore*, survived the war. See Paul Quilès and François Lamy, *Kosovo: Une guerre d'exceptions*, Rapport d'information, Commission de la Défense, Assemblée Nationale, Paris, Les documents d'information, p90.

⁴⁹The President took a substantial amount of criticism in the political arena (from Senator John McCain, for example) and in the media on this statement abandoning one military option. Many observed that announcing one's intentions was not good strategy.

⁵⁰A detailed enquiry was conducted by the French NGO Reporters Sans Frontières (Reporters Without Borders). See Reporters Sans Frontières, *Les bavures médiatiques de l'OTAN*, Dossiers et rapports de mission, 1999.

⁵¹One could argue due to a lack of imagination – how many expatriate Serbs or Serbo-Croat speakers are there in NATO's 19 nations who could have been put on contract to translate NATO material? And how expensive might this been in the context of a multi-billion dollar operation?

⁵²“La guerre du Kosovo ou l'escalade tous azimuts,” *Stratégie*, n° 74-75, 1999, p 12.

⁵³I use the term *lessons identified* in preference to *lessons learned*. We seem not to learn most lessons, but to identify them, forget most, to relearn them again in another context. Writing lessons in an environment like this (or in *lessons learned* reports) is only an initial step in this process.

⁵⁴Admiral James Ellis, U.S. Navy, Commander-in-Chief, Southern Europe (NATO CINCSOUTH) and Commander-in-Chief, U.S. Navy, Europe (CINCUSNAVEUR), “A View From the Top,” briefing, 1999.

SECTION 4—CIVIL- MILITARY DIMENSIONS

CHAPTER XI

The Humanitarian Dimension in Kosovo: Coordination and Competition

Walter Clarke

...Kosovo is a political problem, with devastating humanitarian consequences, for which there is only a political solution...¹

—Sadako Ogata—U.N. High Commissioner for Refugees
(September 1998)

There are significant differences between the experiences, doctrines, responsibilities, and goals of the international humanitarian community and the military forces that support them in armed humanitarian interventions. While no one who has shared one of these intricate civil-military peace operation experiences is likely to disagree with this observation, it is also a fact that the two sides appear to spend little time trying to understand how the other is motivated or how it operates. The matter of mutual unintelligibility is especially confusing, wasteful, and potentially dangerous if those differences are ignored during the planning stages of military deployments to those manmade political-military-humanitarian crises that have become known as complex humanitarian emergencies (CHEs). Kosovo ranks very high on the list of the CHEs that have abused the conscience of the world in the post-Cold War era.

In Kosovo, NATO force planners' ignorance or misunderstanding of the dynamics and capabilities of the international humanitarian community created serious problems for trust and cooperation after the nature of the refugee crisis became clear. These matters eventually worked themselves out during the early months of the Kosovo Force (KFOR) and the U.N. Mission in Kosovo (UNMIK). However, NATO was not responsible for these problems in the civil-military interactions.

The international humanitarian system is frequently hampered by the policies and actions of the principal U.N. nations. If the world does not want to see its militaries engaged in international social work, then it must adequately fund and empower the civilian intergovernmental and nongovernmental agencies that are the core of the humanitarian response system.

But there are broad issues that fall within the competence of the principal world militaries. Despite the considerable experience obtained during the past decade as the world community has responded to many societal breakdowns, most militaries appear culturally unprepared to appreciate the positive side of cooperation with the international humanitarian community. The much-studied intervention in Kosovo may, hopefully, provide an important turning point for these attitudes. The problems associated with the coordination and response to the sudden refugee disaster in Kosovo were so glaring and avoidable that NATO and its members must revise their operational doctrines to avoid such confusion in the future.

An irony is that the military makes much of the alleged incapability of the humanitarian community to contribute to unity of effort. Even within the humanitarian community itself, coordination is voluntary and situational. The enormous diversity of organizational styles, specialized skills, funding patterns, and field experiences of international humanitarian agencies is a strength, not a weakness. These are not agencies that fit neatly into organizational charts and their interrelationships are often ambiguous, if not sometimes competitive. They do not submit themselves to a military chain of command. But their independence, impartiality, and neutrality in the midst of chaos and the fog of peacekeeping are also a strength, because humanitarian agencies can deal with all non-belligerents and gain victories without firing a shot. The elusive and ambiguous issue of unity of effort in the context of Kosovo is discussed at greater length below.

The military must accept that there is a fundamental difference between its training and attitudes and the experience of the international organizations and nongovernmental organizations (NGOs) engaged in relief and rehabilitation. As per their mandates, the humanitarian community must focus its planning energies on the victims of misadministration, cruelty, and disorder. These civilian organizations are committed by formal agreements and tradition to assist all non-

belligerents in need, without regard to ethnic group or political faction. The military in such operations must become familiar with the ethics of the international humanitarian community. The fact that impartiality and neutrality are critical components of humanitarian strategy is well known, but the combination of these two issues is another reason why civilian agencies and military forces have such different responsibilities in operations such as in Kosovo.

The ambiguities of these parameters were present among the planning concerns of each of the civilian organizations that had to close down their operations in Kosovo when the air war began. Cornelio Sommaruga, the President of the International Committee of the Red Cross, stated in late May that “the most urgent thing in Kosovo right now is the need for the creation of a humanitarian space...a physical, political, and psychological space in which neutral, impartial humanitarian organizations such as the International Committee of the Red Cross can work.” While the ICRC head was also worried about the attitudes of the Kosovo Liberation Army (KLA), whose position was greatly strengthened during the air war, NATO had clearly not had meaningful discussions with the ICRC about these fundamental civil-military issues. Sommaruga showed his concern about the post-air war relationship: “Where are we allowed to work, how much notice do we have to give for movements of trucks?—what we will actually be pushing up against is the military imperative.”² Militaries have difficulty with the concept of neutrality and acceptance of other priorities.

As the institution entrusted with providing a safe and secure environment for international humanitarian efforts, the military has a crucial protective role to play. While the military is expected to behave impartially and to apply its mandates fairly, military forces have no credibility if they strive to avoid politics on the humanitarian battlefield. A military deployment into a sovereign state, especially if its permissions are ambiguous—certainly the case in Kosovo—is a profoundly political act. Deployed beyond its borders, a military force may hope to be seen as a humanitarian actor, but that is both logically impossible and militarily self-defeating. A well-armed force in a politically disturbed environment must send a clear and unambiguous message that it is not aloof to what is actually transpiring on the ground. The military component cannot ignore injustice and lawlessness on the battlefield, and its rules of engagement must be crafted to ensure that its actions are productive to the overall goals of the operation. In this respect, the operation in Kosovo appears to have

had fewer problems of maintaining political clarity than the parallel operation in neighboring Bosnia.

A European liaison officer assigned to the NATO J-9 (civil-military operations) staff at the outset of the KFOR operation stated that “if you had seen the chaos in civil-military relations during the first 2 months of the NATO deployment into Kosovo, you would have said that we would never make it!” Fortunately, both the military and civilian sides of the Kosovo operation were quite professionally led, and productive civil-military relations were cemented within the early months of the commencement of joint activities on the very special Kosovo humanitarian battlefield.

Background to Tragedy

The collapse of the former Soviet Empire and the dissolution of Communist authoritarian regimes throughout Eastern Europe in the late 1980s and early 1990s left several of these dictatorships in place, notably in the Balkans. In the history of the Balkans, there were a few pieces and fragments of former empires, which did not appear to be significant in the heavy tides of ethnic nationalism, which caused the state of Yugoslavia to collapse in 1991. Kosovo was a confetti of empire which had long been a matter of domestic contention in Yugoslavia and its status was omitted during the negotiations that led to the Dayton Agreement. Despite former Yugoslav leader Milosevic’s cruel manipulations of the Albanian ethnic population in Kosovo, the province did not become an area of serious international attention until 1998.

Kosovo was not an easy case for world concern. Under international law prevailing since the adoption of the U.N. Charter in 1946, all military interventions must either be sanctioned by the United Nations Security Council or be the consequence of multilateral or bilateral defense agreements. Given that neither Russia nor China in 1998-99 were likely to veto a resolution calling for U.N. intervention in the political and humanitarian emergency prevailing in Kosovo, NATO acted on its own.³ The NATO decision to intervene was driven by a number of international humanitarian and political imperatives based on halting the ethnic pogroms carried out by the Yugoslav authorities. Kosovo became the first case of a totally unsanctioned military intervention to halt the depredations of a government against its own citizens. This unique situation was clearly one of the reasons for the difficulties in

coordination and understanding between the military and civilian participants at the outset of the Kosovo crisis.

These civil-military planning difficulties were not just legal and/or doctrinal. The uncertain relationship between the military and civilian sides during the air war manifested itself in an unhealthy competition between international humanitarian agencies and NATO when the air war was suspended. These attitudes were not necessarily based on skepticism or ignorance about the capabilities of the international humanitarian community. There were serious military institutional issues pertaining to the releasing of critical information, the lack of humanitarian input to planning, and the impatience on the part of military commanders with the relatively slow pace of international organization administrations.

NATO's concern about its public image was also a factor. It also appears likely that certain NATO forces wished to appear generous in the face of the enormous humanitarian crisis that developed for several weeks far below NATO's high-flying bombers. However, the members of the multinational NATO alliance and their partners each responded to the refugee disaster according to their own means and preferences, creating an image of competition within the military and with the international humanitarian specialists. This response was both dysfunctional and wasteful, and could have complicated the achievement of the overall humanitarian and military objectives of the Kosovo operation. Should there be future Kosovos, as there are likely to be, there must be a greater effort to build a humanitarian-military partnership which is prepared to recognize the strengths and responsibilities of each participant prior to the commitment of the military force.

Fortunately, the Kosovo operation has benefited from a substantial amount of attention by both participants and independent observers, and several very useful after-action reviews are now available, including those of certain U.N. agencies, NATO, DoD, NGOs, the State Department, and a number of independent academic groups and functional commissions.

The Kosovo Refugee Crisis

Nearly all post-Cold War armed humanitarian intervention situations are the direct response to crises that are defined by widespread repression against civilian populations. With the conscience of the

world still bothered by the lack of response to genocide in Rwanda, and the inability of the United Nations to contend with ethnic cleansing in Bosnia, Kosovo was important. Most governments are still searching for some formulae to handle the rising numbers of refugees and internally displaced persons (IDPs). The lessons of Kosovo are especially pertinent for a better understanding of the still ambiguous role of the use of force in humanitarian operations.

Despite a decade of provocative actions against the large Albanian majority in Kosovo by the Serbian-dominated government in Belgrade, the triggering event that eventually led to intervention by NATO forces may have come on February 28, 1998.⁴ On that day, Serbian police arrested Adem Jashari, a local Albanian leader in Perkaze, who had reportedly joined the Kosovo Liberation Army (KLA). In the following week, 58 members of his extended family were systematically exterminated by Serbian military and police actions. When this crime became known, villages throughout Kosovo set up local defense groups to defend themselves. Although the KLA evidently played little role at this point in establishing these self-defense groups, the village defenders called themselves KLA, which facilitated the spread of that group. The conditions were set for ethnic cleansing and civil war. The world press soon took an interest in the growing number of Serbian massacres and the Albanian resistance throughout Kosovo. Milosevic had gone too far; he hoped to handle Kosovo as a minor internal problem, but his scheme of restoring a Serbian majority to Kosovo by chasing the Albanians away, or killing them outright, was simply too ugly to escape the world's attention.

Attempts were made to regulate the conflict through diplomatic means. The United States and NATO embarked on a gradually escalating campaign of words and gestures designed to increase pressure on Serbian authorities to relent in their campaign against both the KLA and innocent civilians. In June 1998, the NATO Council directed the military planning staff to develop a full range of options for the deteriorating situation in Kosovo.⁵ Within days, NATO held air exercises over Albania; NATO clearly had the capability to project power anywhere over the troubled Balkans.

In October 1998, U.S. Special Envoy Richard Holbrooke and Serbian leader Milosevic negotiated preliminary Serbian troop withdrawals from Kosovo, but violence returned within a few weeks of that agreement.

Efforts by the United States and Europe to defuse the rising tensions in Kosovo led to direct negotiations between Serbian and Albanian authorities at Rambouillet, France in January-March 1999, but these efforts failed. The Serbian offensive against the KLA and Kosovar Albanian civilians grew in intensity, and the world became aghast at the savage war of the Serbian Government against its own ethnic Albanian citizens. In a dramatic move that surprised many, some 2,000 international observers placed in Kosovo in the autumn of 1998 in the so-called Kosovo Verification Mission (KVM) under the authority of the Organization for Security and Cooperation in Europe (OSCE) were quickly removed in mid-March. Most international agencies similarly evacuated their personnel from Kosovo in the face of potential hostilities. Among the last to leave were nineteen members of the International Federation of Red Cross and Red Crescent Societies, who left Kosovo on March 29, 1998.⁶

On March 24, 1999, NATO launched an air campaign over Kosovo designed to drive Serbian forces from the province. This action, done without the sanction of a U.N. Security Council Resolution, but judged illegal but legitimate by an Independent International Commission,⁷ caused great concern among the international humanitarian community. How could that community, foresworn to apply assistance impartially and without taking sides, coordinate with NATO, an active belligerent in an unsanctioned war?

This dilemma greatly complicated relations between NATO and the international humanitarian community until the U.N. Security Council adopted resolution 1244 on June 10, 1999. In so doing, the Security Council placed an *ex post facto* international stamp of approval on the NATO military campaign. UNSCR 1244 stipulated the return of all refugees and provided ground rules for the establishment of an international interim regime to govern Kosovo during its recovery. Some agencies, especially the UNHCR, remained concerned about working with an active belligerent but quickly resigned itself to working with military forces because no other organization could respond so effectively to the urgent humanitarian demands of the situation. The U.N. Security Council had learned about coordination issues from the operations in Bosnia, and instructed the Secretary General in paragraph six of UNSCR 1244 “to instruct his Special Representative to coordinate closely with the international security presence to ensure that both presences operate towards the same goals and in a mutually supportive manner.”⁸

During the subsequent 9 weeks until the completion of the air campaign on June 11, nearly 860,000 Kosovo Albanians fled or were expelled to Albania (444,000), Macedonia⁹ (344,500) and Montenegro (69,900). An estimated 590,000 more were displaced from their homes. An estimated total of 90 percent of all Kosovar Albanians became homeless in this period.¹⁰ Such vast numbers in such a narrow time period were unusual in the history of refugee operations; only during the Kurdish-Iraqi war of 1991 and the period following the Rwandan genocide of 1994 had the UNHCR seen such refugee and displacement figures.

Despite the buildup to the air campaign, the UNHCR and the international humanitarian community in general were unprepared and initially overwhelmed by the enormous numbers of refugees that were generated by increasingly repressive Serbian acts during the air war.¹¹ Although most observers agree that the basic needs of the refugees were met during and after the air war, this was a particularly stressful period for military-humanitarian relations. The UNHCR remains especially troubled because during this period it saw itself marginalized by uncoordinated bilateral efforts carried out by various NATO coalition members and competition by other international agencies. Internationally accepted standards for refugees were either unknown or scorned by participants, causing great confusion and considerable waste. With a declining number of personnel in the area, the UNHCR was primarily focused on the needs of the estimated 260,000 IDPs in Kosovo. Refugees were a secondary concern with an estimated 35,000 in countries bordering the former Yugoslavia.¹² While there was great concern within the humanitarian community about the need to evacuate monitoring and humanitarian personnel in the event of a conflict, conventional wisdom within the community was that the air war would be a solution rather than a problem. The air campaign would be brief, and in the absence of Serb army and police, humanitarian efforts would be adequate to cover basic human needs.

Various agencies had widely differing estimates about the scale of refugee flight expected when the air war began, with the OSCE initially planning for 50,000. After several discussions with both military and diplomatic authorities in early March 1999, the UNHCR settled on 40,000 to 80,000 refugees as a planning figure. Some alarmists believed that as many as 100,000 new refugees would be generated by the air campaign, but they were confident that the UNHCR could handle that number, and that was the number adopted by the UNHCR in its final report

before NATO started dropping bombs. Following the first salvos of the air campaign, however, the UNHCR found itself seriously undermanned and unable to handle the requirements.

There are reports that indicate that U.S. military and civilian intelligence services were aware of Milosevic's plans to initiate massive reprisals in the event that NATO decided to intervene in Kosovo. If so, it is unfortunate that some means to inform the humanitarian community of the broader threat was not available.

The internal debates within NATO and, notably, within the U.S. European Command (EUCOM) about the virtues of air or ground-based combat to rid Kosovo of its Serbian overlords focused on potential personnel losses. From the humanitarian perspective, the decision to bomb Serbian targets from 15,000 feet was a particularly difficult one to accept because of the increased risks of actually bombing the victims of Serbian repression. After several NATO bombing errors led to a number of non-combatant deaths, military-humanitarian relations were greatly strained. Whether it was the stressed relations with the humanitarian community that they did not understand or trust, guilt over the bombing incidents, or the enormous internal displacement and flight of refugees into surrounding countries, the various militaries within the alliance all looked inwardly in planning for the victims of the Kosovo conflict.

UNHCR Is Unready

In Albania, where some 64,000 refugees arrived around in late March, there was a single national staffer in the UNHCR office at the Kukes crossing point. The small UNHCR office in Tirana quickly initiated emergency procedures in order to provide more staff and refugee resources for the Kukes office. An emergency response team (ERT) was set up at UNHCR Geneva on March 29, and it was ready to travel the next day, well within the normal 72 hours emergency response time standard set by the UNHCR. Its departure was delayed an additional day because NATO/EUROCOM in Tirana could not provide an arrival slot for the UNHCR-chartered aircraft.¹³ Particularly vexing to the UNHCR was the fact that the same day in which the UNHCR was denied a landing slot, the EU Commissioner for Humanitarian Affairs arrived in the region on board a NATO aircraft accompanied by the

Deputy SACEUR.¹⁴ It took the UNHCR ERT a full day to travel by road from Tirana to Kukes, and it did not arrive on the scene until April 2. In the meantime, the UNHCR Special Envoy in Tirana had left for Kukes on March 30.

No international agency can compete, however, with the resources available to an individual sovereign state determined to exercise national policy imperatives. This was certainly the case of the UNHCR. The Interior Minister of the Italian Government had already been to Kukes, and she met the UNHCR Special Envoy heading up the road while she was on her way back to Tirana. The Italians already had a convoy of relief goods on the road to Kukes; in fact, the convoy was blocking the road where the two officials met. The Italian Government acted quickly because it feared an avalanche of Albanians pouring clandestinely by boat into Italy following the several thousand illegal Albanian refugees who were already there. Sharp words were reportedly exchanged; the Italian minister made special note of the fact that approximately 85,000 refugees had already presented themselves at the border, and there was no sign yet of UNHCR assistance.¹⁵

On the Albanian front, there was clear evidence that the competition between bilateral national interests and international solutions was already causing problems because the lack of clarity about who was in charge created opportunities for potential manipulation by end-users. For the Albanian Government, the Kosovo crisis was a means to advance its relationships with NATO and the West, and it became the only front line state to offer full and unrestricted use of its territory and air space to NATO. In contrast, the UNHCR had nothing to offer the Albanians politically, and it saw the Albanian Government place primary responsibility for response to the refugee crisis in the hands of NATO, which sent in its own team of experts to coordinate the situation. National delegations from Germany, France and Italy visited Tirana on March 31 to discuss assistance to the refugees. These talks developed into an EU meeting held in Luxembourg, where specific assistance packages were discussed, including the relocation of many of the refugees from the border zone to third-party countries. The UNHCR was not invited to any of these various meetings. It was only informed later of the results.

In the crisis headquarters set up in the Albanian Prime Minister's office in Tirana, an Emergency Management Group (EMG) was established.

The EMG included a representative of the Prime Minister, two representatives of the OSCE, an American Embassy staffer and the local mid-level Tirana UNHCR representative. In the quest for institutional supremacy, the OSCE, which has long been critical of the UNHCR's primary role in refugee support and, in any case, because it represented another meaningful outlet to the western world for the Albanians, the OSCE won out. Proof of this came in late April, when the Italian Government proposed to turn over its refugee camps to the UNHCR. The Albanian Government initially protested, but with obvious misgivings, eventually agreed.

Each of the former Yugoslavian states included a mosaic of ethnic groups, and in Macedonia, approximately 25 percent of the population is composed of Albanians. Before the air campaign, the Macedonian Government had freely permitted refugees from Kosovo onto its territory. It was unprepared for the refugee onslaught that began to skyrocket on March 30-31. With a line of cars and trucks stretching out over six miles from the crossing point at Blace, and the arrival of six trains on April 1 containing 25,000 refugees, the Macedonians closed the frontier. It feared that unrestricted access to Macedonian territory by the refugees would upset the small country's fragile ethnic balance. Only 3,000 of the train refugee arrivals were processed. There was no turning back, however, for the tens of thousands of prospective refugees at the border. The spectacle of the refugee hoard blocked on the large muddy field outside the Blace crossing was flashed on nearly every television screen in the world. This was a crisis that only the military could resolve. Although the UNHCR was initially reluctant to turn the responsibility of building camps over to the military, NATO forces built several refugee camps in Macedonia, some literally overnight. Between April 4-6, the Blace field was emptied.

Although some refugees found their way to Montenegro, the presence of Serbian military forces in that part of former Yugoslavia made that a very dark alternative for ethnic Albanians. The UNHCR also fretted over the lack of standards for the camp construction, especially in Albania. The military units involved used the only plans they knew for building housing, and it was clear that many of the resulting structures were more suited to serve as barracks than they were for refugee families. The standards for construction varied from the air-conditioned premises built by the Kuwaitis to the rudimentary shelters built by the Turkish contingent. The care and feeding of the camp populations was also

vastly different, as certain NATO units provided three warm meals a day, and the Americans passed out meals ready to eat (MREs) once a day. This competition not only demonstrated significant disparities between various national camp providers at a time that NATO was struggling to maintain the appearance of unity but also created a very difficult situation for the transition to NGO control of the camps. As Karen Koning Abuzayd, regional representative for the UNHCR, noted in a Washington, D.C., press conference during the peak of the crisis, certain refugees “in the Italian camps and German camps [have] been provided three hot meals a day and hot showers. This has been another one of the problems we face when the NGOs take over. None of us can quite keep up the standard of the Italian camp or the German camp.”¹⁶ There were surprises on both sides. After a 600-man Italian military unit set up and began administration of a refugee camp, the force commander was astonished when just a handful of UNHCR personnel showed up to take charge of the installation.

The military construction was vital under the circumstances; it provided shelter for those refugees who had no families in Albania to assist them. According to academic analysts, of the 480,000 refugees who took refuge in Albania at the peak of the crisis, only 87,000 were originally placed in tented camps, thereby qualifying for more secure shelter. About 100,000 were placed in collective shelters and 300,000 stayed with relatives, friends and rented quarters.¹⁷

Part of the agreement between the Macedonian Government and NATO to build the temporary camps was that many of the refugees were admitted on a provisional basis and that they would be quickly relocated to other countries. Although the relocation arrangements were in direct opposition to international refugee conventions that call for free entry of refugees into receiving states, several thousand refugees were transported, with U.S. assistance, to Turkey, Greece, and Albania. A later offer to accept refugees was accepted from Norway, which took 6,000 refugees from the scene. For a summary of the refugees taken from Macedonia in June 1999, see Figure 1.

Germany 14,254	Sweden 3,245	Czech Republic 824
Turkey 8,013	Australia 2,932	Slovenia 745
Norway 6,070	Denmark 2,507	Croatia 284
United States 5,997	Switzerland 1,517	Israel 206
Italy 5,829	Portugal 1,271	Malta 105
France 5,338	Spain 1,240	Slovakia,
Canada 5,174	Belgium 1,223	Iceland,
Austria 5,080	Poland 1,049	and
Netherlands 4,067	Finland 958	Romania <100 each
United Kingdom 3,446	Ireland 893	

Figure 1. Refugees Evacuated from Macedonia (June 1999)

In the swirl of diplomatic activity that surrounded the crisis at the Macedonian and Albanian borders, local UNHCR representatives faded into the background. The international After Action Review team engaged by the UNHCR is unstinting in its criticism of the UNHCR for the inability of its local officials to project a stronger agency presence during the crisis period.¹⁸

As the air war increasingly frayed the FRY economy and Serbian public support of Milosevic waned, there were intensive diplomatic exchanges within the NATO alliance to bring the campaign to an end. On June 1, 1999, Serbian authorities informed the German Government that it accepted the stipulations proposed by the Group of 8 and called for an end to NATO bombing. Two days later, a joint EU-Russian delegation traveled to Belgrade, where it seemingly secured FRY agreement. However, on June 7, Belgrade signaled that it could not agree to the terms for the complete pullout of military and police units from Kosovo. In response, NATO turned up the pace of bombing, and Belgrade finally capitulated.¹⁹

On June 9, 1999, NATO and FRY officers signed a military-technical agreement (MTA) which provided for the rapid withdrawal of all Yugoslavian military and police forces from Kosovo. The NATO-led force to be deployed into Kosovo was designated the Kosovo International Security Force (KFOR). On June 10, NATO Secretary General Solana announced the suspension of air strikes. By June 20, all Serb forces had completely evacuated Kosovo, and Solana announced that the bombing campaign in the Federal Republic of Yugoslavia was finished.

In addition, there was a considerable scramble among the NATO coalition and other members of the world community to relieve the pressure on Macedonia and the plight of the refugees who were not permitted to remain there. More than 82,500 Kosovars were evacuated

from Macedonia in June 1999. Although the political purposes of this massive movement of refugees were clear, for many in the humanitarian community, this hurried movement represented a significant breach of existing international refugee standards. Existing conventions require that refugees be given temporary asylum as soon as they cross an international frontier. Moving them to a third country amounted to a new form of *refoulement*, or rejection of asylum.

The Refugee Rush Home

The United Nations system relies greatly on its abilities to maintain reasonable relations with all sides of a conflict, particularly when a substantial humanitarian crisis threatens to erupt. This was certainly true during the air war over Kosovo, when U.N. Secretary General Kofi Annan dispatched one of his principal deputies, Under Secretary General Sergio Vieira de Mello, to head a Needs Assessment mission to Belgrade and Kosovo. The mission, which included representatives from numerous international humanitarian agencies both inside and outside the U.N. community, spent May 15-26, 1999 crisscrossing Serbia and Kosovo. In his report, Vieira de Mello indicated that he and his delegation had received good cooperation with the Serbian Government, although much less so with the Serbian military. His team met with representatives of the Albanian ethnic IDPs, finding in some areas over 80 percent of houses destroyed, a near total absence of public utilities and services. The Vieira de Mello mission found “indisputable evidence of organized, well-planned violence against civilian, aimed as displacing and permanently deporting them...” With more than two-thirds of Kosovo’s population dispersed through the countryside and in surrounding countries, the mission pronounced the humanitarian needs of the province to be urgent and immense.²⁰ The U.N. system began to prepare for the post-air war Kosovo humanitarian emergency.

On the basis of his vast experience in disasters and peace operations around the world, and his preliminary report on the Kosovo crisis, Vieira de Mello was named Head of Mission in Kosovo, pending the arrival of Bernard Kouchner, whose selection as the Special-Representative of the Secretary-General in Kosovo was announced on June 1. Heading a large team of experts, and a 50-vehicle convoy, including 250 tons of relief goods, Vieira de Mello arrived in Pristina on June 13. Both the United Nations and NATO was already aware that, in

the interim period after the withdrawal of Serbian forces and the establishment of an international presence, the KLA was setting up its own administration in liberated areas. This would continue to be a problem for several weeks, despite the stipulation in the MTA that the KLA would soon disband itself.

As in Bosnia, the initial interests of the participating governments and international agencies were to provide assistance to homeless IDPs and to get the refugees home. With most routes made risky by the presence of landmines, and with tens of thousands of homes rendered uninhabitable through Serbian actions during the ethnic cleansing period, it was believed that repatriation of refugees and the resettlement of IDPs would take 3 or 4 months.²¹ The UNHCR informed refugees arriving at the frontiers that they were proceeding at their own risk if they did not wait for certification of the routes. In a visit to Macedonia on June 23, U.S. President Clinton pleaded with a refugee group not to move too quickly.²² In fact, the return of Kosovar Albanians almost immediately reached flood proportions. Winter comes early in the Balkans, with snow often in September, and everyone wanted to have his or her families under cover before the cold season. On June 23, the UNHCR reported that 34,500 Kosovars crossed the border from Albania that day, bringing the return of refugees “to more than a quarter of a million the overall number of returnees in just 9 days.”²³ By the end of July 1999, the cumulative total of refugee returns to Kosovo was 737,000.²⁴ Those Kosovars who were refugees from both Kosovo and Macedonia were returned from their diverse countries of asylum in July and August 1999 in a series of airlifts organized by the International Organization for Migration (IOM), working in partnership with the UNHCR.

The Competitive Scramble on the Humanitarian Battlefield

The competition among military units and between the military and the international humanitarian community to demonstrate their capabilities to bestow largess on the victims of the Kosovo civil war provided displays of uncoordinated national and organizational chauvinism that has few equals in the history of multilateral humanitarian operations. Among the many examples of bilateral competition and national favoritism were the following:²⁵

German food allocated to the U.N. World Food Program was routed to Kosovo under German military control for use in German military bakeries producing bread for Kosovar civilians being assisted by German NGOs.

The French military contingent did not appear to have substantial assistance funding for civil projects, so it focused on French language instruction.

Greek bilateral assistance went directly to Greek military and civilian engineers who were building shelters for Kosovars.

The Danish battalion insisted that the Danish aid agency (DANIDA) provide funding in their sector, although no housing reconstruction or rehabilitation issues existed.

The UK aid agency gave grants to British KFOR units for small projects that easily could have been handled by international or domestic NGOs.

The Italian contingent was particularly adamant about retaining control over national funding, and its aid funds were allocated to the Italian civil defense ministry for civilian police training in its sector.

The European Community Humanitarian Office (ECHO) reportedly turned down projects to be funded by NATO contingents because it could not guarantee that their traditional vendors would undertake these projects.

Another area of competition, which impeded unity of action in Kosovo involved the way different military units supported their own national nongovernmental organizations (NGOs). Some NATO units were funded by their ministries of defense specifically for this purpose.

The Greek contingent appeared uncertain about its plans for the maintenance of a newly built refugee camp, but hurriedly passed that responsibility over to an NGO when the owner of the land upon which the camp was built showed up with a bill for the use of his property.

There was a proliferation of so-called briefcase NGOs, principally in logistics, whose presence was fostered by national governments of forces in the operation to obtain contracts from the international agencies. These acted as agents for the forces in dealings with local truckers, thereby skimming some of the benefits for outsiders and possibly creating an image of impropriety for the military forces.

As the world rained largess on Kosovar refugees and IDPs, there was little transitional planning on how to turn the newly built installations over to the humanitarian operators. After certain administrative improvisations, the camps were turned quickly over to humanitarian agencies. Ironically, all of the refugee camps built in Albania, Macedonia, and elsewhere outside of Kosovo, were used only during the air war and for a few weeks after the suspension of hostilities. Nearly all of the camps were emptied within weeks of Serbian capitulation at the end of the air war. The humanitarian agencies were left with the expense of disposing of equipment which was either too expensive and inappropriate for them to use in their own relief campaigns, thereby diverting their attentions from other more pressing requirements in Kosovo.

In the midst of this post-air war humanitarian spree, U.S. defense officials decided to make public their dissatisfaction with the United Nations civilian effort in Kosovo. On July 20, 1999, both Defense Secretary Cohen and the Chairman of the Joint Chiefs, General Henry H. Shelton appeared before the House and Senate defense committees and complained that the U.N. was moving too slowly in Kosovo.²⁶ In an uncharitable and undiplomatic phrase, Secretary Cohen lamented to the press and sympathetic Members of Congress that “professional soldiers should not be expected to adopt policing, administrative, and judicial roles whilst grappling with huge population flows, de-mining and aid distribution...” In fact, all of these responsibilities were soon taken over by international agencies and nongovernmental organizations.

Public complaints from the U.S. Government about U.N. performance in Kosovo brought a rejoinder from Secretary-General Kofi Annan, who remarked, “There is too much work to do for finger-pointing.” His senior advisor, Assistant Secretary-General John Ruggie, stated that the U.N. was moving at unprecedented speed to get an international police force on the ground and to set up a civilian administration. Ruggie further noted that “it was never planned that the U.N. operation would be fully operational within 6 weeks of the Security Council’s adopting a resolution. That would have been humanly impossible.”²⁷ No one would necessarily disagree with the frustrations of the U.S. defense chiefs, but the unfortunate spectacle of the U.N. and NATO leadership exchanging brickbats at the beginning of a major civil-military operation would not have happened had there been greater understanding on the part of the U.S. military of the procedures and processes of the international humanitarian system. In its review of the Kosovo

operations, the State Department stated that the “UNHCR’s response was weak, [but] the system which supports the international agencies is also very weak.”²⁸

Rebuilding Kosovo

U.N. Security Council Resolution 1244, adopted on June 10, provided for the “deployment in Kosovo, under United Nations auspices, of international civil and security presences.” The resolution empowered the Secretary General to appoint a Special Representative “to control the implementation of the international civil presence” and further requested the Special Representative “to coordinate closely with the international security presence to ensure that both presences operate towards the same goals and in a supportive manner.” The designation for the operation was Operation Joint Guardian. The text of resolution 1244 suggested the four pillars for what became known as United Nations Mission in Kosovo (UNMIK). Emulating the framework selected for implementation of the Dayton Accords, the civilian side of the operation formed four pillars for the interim administration of Kosovo. The organization of the implementation mechanism for Kosovo rehabilitation was formed as follows:

- Pillar I: Humanitarian affairs, under the direction of the UNHCR;
- Pillar II: Civil administration, led by UNMIK;
- Pillar III: Democratization and reconstruction, under the auspices of the OSCE; and
- Pillar IV: Economic development, led by the European Union (EU).

Former French Minister of Health and founder of the *Medecins sans Frontieres* (MSF) Bernard Kouchner was named Special Representative of the Secretary General (SRSG) and took office in Pristina on July 15, 1999. Although UNSC 1244 accorded virtually unlimited powers to the SRSG, his focus was on the rebuilding of civil society and the structures of government in Kosovo. U.N. personnel insisted that Kosovo is not a protectorate. They emphasized that UNMIK was an interim administration which was designed to turn over its executive functions to the people of Kosovo in as brief a time as possible. With a small but devoted nucleus of international civil servants, whose numbers never

exceeded 240 expatriate personnel, Kouchner governed a province of approximately 1.5 million seriously uprooted inhabitants, establishing everything from a new judicial system to voluntary agencies.

Meeting daily, the SRSG and the KFOR commander built an atmosphere of trust and friendship that smoothed over many of the coordination issues that emerged during the air campaign and the initial intervention on the ground. The civil-military operations (CMO) system established by NATO is certainly a model for future multilateral operations. There remain some rough edges. From discussions with participants on both sides, it is clear that there remain some very serious divides between the two cultures. Although both communities relied upon the structures that were created over the two years of experience working together, there was still very little understanding of each other's working cultures. There remained an us-and-them mentality. Military representatives are somewhat disdainful of their civilian clients and fret that civilians are not sympathetic to their concerns.

UNSCR 1244 provided a clear sanction for UNHCR to coordinate the humanitarian operations in Kosovo. It took a while for that idea to take hold, but the return of Kosovar Albanians to their homes was largely successful. The issue of Serb displacement and Kosovar Serbian refugee populations went beyond the mandate of the UNHCR and remained dependent upon the ability of the OSCE to develop space for the Serbs to co-exist with their Albanian neighbors in a democratic Kosovo. The humanitarian phase of the Kosovo intervention could be deemed successfully completed on June 15, 2000, when the UNHCR humanitarian pillar was dissolved. The UNHCR remains in Kosovo as one of several international humanitarian agencies.

At the beginning of 2001, there was a significant change in the leadership of UNMIK. Bernard Kouchner was believed to be a strong candidate to take over the leadership of the UNHCR from Mrs. Ogata, who was retiring after 10 years as UNHCR High Commissioner. Kouchner, however, was passed over in favor of a Dutchman, Karl Lubbers. Kouchner returned to the French Government to his former position as Minister of Health.

In January 2001, Hans Haekkerup, a former Danish diplomat and defense minister replaced Kouchner. He injected his own team into the UNMIK operation. He put off the provincial elections that were originally planned for the spring of 2001 to late autumn. The SRSG now meets

three times a week (rather than five during the Kouchner years) with the military commander. Haekkerup's initial priorities were focused on (a) broadening Kosovo's legal framework for the early installation of a provisional self-government, (b) development and execution of the law through more intense police training and the establishment of competent judiciary, (c) improving relations with the FRY, including the opening of an UNMIK office in Belgrade, and (d) improved Kosovar administration to resolve property issues, the development of a provincial budget, and the re-establishment of industries which can contribute taxes to the provincial government.²⁹

The change of administration in Belgrade under newly elected President Kostenic eased relations between the international Kosovo operation and the FRY. UNMIK's decision to permit the Yugoslavian army to reoccupy its positions in the Presevo Valley demonstrated that growing confidence.

The NGO presence in Kosovo decreased substantially. The range of NGO activities narrowed to support of UNMIK's efforts to foster societal rehabilitation and related nation-building subjects. The operation still lacked overall coherence in the sense that the political end-state remained defined in terms that were utterly unacceptable to the Kosovar Albanian population. The U.N. operation in Kosovo maintained that it was preparing a self-governing Kosovo to remain in the Yugoslav Federation. The ethnic Albanian population appears to assume that the only goal of the current operation can be independence.

Unity of Effort

It is easy to speak of unity of effort when each side assumes that its objectives are the only valid ones in an operation. Kosovo provides a good example of the observation that the worlds of the military and the humanitarian communities cannot be more different. Militaries are created to defend their national territories, and if deemed to be in the national interest, to project power beyond their national boundaries. Militaries are command-driven, complex, and comparatively rich in resources. When compared to the voluntary, loosely structured, and meagerly endowed international humanitarian community, there can be no wonder that so many of the stricken peoples and states in the Balkans look back so favorably at the NATO intervention. The military can mobilize personnel and resources like no other institution. It can

carry those resources great distances. The humanitarian world is very different. It is primarily built on donations, good intentions, and individuals willing to risk their safety for their beliefs and ideals. These sentiments are not totally foreign to the military; we all know military personnel who have retired to work in international humanitarian organizations and nongovernmental agencies. But the primary role of the military is to provide a meaningful security presence. It must be prepared to accept the fact that this is an inherently different posture than the civilian community it supports, and that unity of effort has only the most general common meaning in a peace operation. Please examine Figure 2 for a summary of those distinctions.



Figure 2. The Conflict of Cultures

Whatever the distinctions, in emergency situations, the military must accept that there can be no substitute for the international humanitarian community. During the past decade, that community has further refined its specialties and become much more effective in responding to human needs and the restoration of civil societies. It is incumbent upon all military planners to know which groups are on the ground prior to the

military deployment and the identities and specialties of those that show up because the military has restored a secure environment so that they may operate. From the perspective of its prospective civilian humanitarian partners, the military faces very unconventional enemies in peace support operations (see Figure 3).

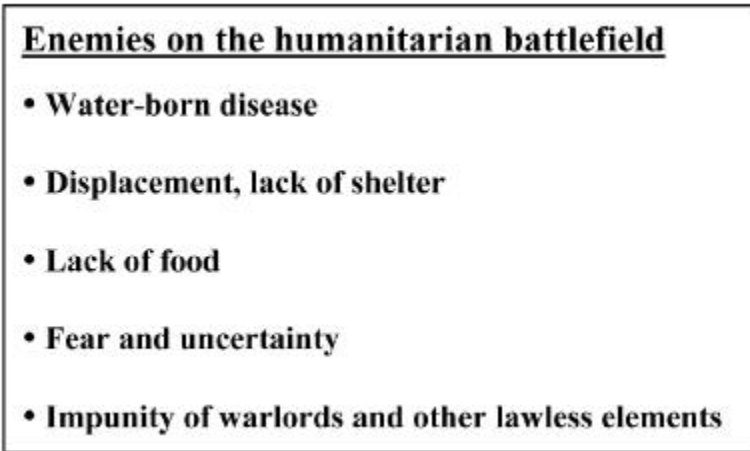

Figure 3. Enemies on the Humanitarian Battlefield

Not many humanitarian field workers would necessarily recognize the military five-paragraph field order format indicated above. And in the elaborate crisis-action planning context of a military operation, these items figure only on the far periphery of concerns. There are no humanitarian voices to be heard at the national or operational levels in force planning for armed humanitarian interventions. Until national policies and military doctrine can accept victims-based planning, true unity of effort on the humanitarian battlefield will be illusory.

Unity of effort, as a military mantra, may be misconstrued by the civilian participants in a humanitarian operation as a semantic device to place the military in command of the overall operation. Given the inherent leadership qualities and discipline of the military, this may appear to be an attractive possibility for tactical commanders. This is a recipe, however, for the misapplication of resources and probably ensures a very long stay for the military participants. The key to effective coordination lies in mission planning. In an era in which civilian and military agencies commonly work together on the humanitarian battlefield, it is within the competence of military planners to either solicit information directly from the

international humanitarian agencies and principal NGOs who are already there or who plan to take part. A properly planned civil-military operation must include firm facts or estimates on the objectives and facilities of the international humanitarian community. Comprehensive resource planning would require all parties to be open and frank with each other. Given the reservations about working with the military on the part of many international organizations and NGOs, this will prove difficult, but it is vital for the efficiency and effectiveness of such operations. This offers a more practical approach to cooperation than simply invoking unity of effort as a general goal. A more useful slogan would be “broad-based comprehensive planning for common purposes,” or some other more artful phrase that might focus our planning energies on developing logical synergies for the civilian and military components engaged in preparing to respond to CHEs.

Some Other Lessons from Kosovo

Better understanding of the civilian humanitarian actors. While military personnel may complain that it is unfair to give them the primary responsibility for understanding the complexities and potential requirements of civilian organizations on the humanitarian battlefield, but as the larger, better-endowed, and more disciplined institution, only the military has the resources to take on that task. The resulting assessments and understandings of the humanitarian community should be made part of the standard deliberative planning processes for NATO militaries long before humanitarian contingencies occur.

The need for military transparency. Although the level of sophistication of the LNO services rendered by KFOR is higher than in any other civil-military operation with which we are familiar, there remain some bitter attitudes that the civilian side makes little or no effort to understand how the military works. It is a fact that many representatives of humanitarian agencies harbor bitter resentment and opposition toward the military profession. This must be overlooked. They do not have the time to understand military organization, and the sure sign of LNO effectiveness is to ensure that prospective clients look to them as their primary contacts.

Learn the specialties of the humanitarian community. Everyone knows that there are significant differences between the doctrines, responsibilities, and goals of the international humanitarian community

and the military forces that support them in peace operations. The results in the field, however, indicate significant gaps in military awareness of these differences with resulting confusion, waste of resources, and the possibility of increased risks to our personnel. There is a critical need for senior military leaders and campaign planners to expand the traditional military doctrine and see the positive side of cooperation with the international humanitarian community.

It takes awhile for the international community to respond. Many agencies will already be represented on the ground before militaries are deployed. However, as learned in Kosovo, while the international community includes expertise for nearly any humanitarian or peacekeeping mission, its funding capacities are limited for quick onset emergencies. There are special military requirements for the outset of such missions. It may be necessary to provide some (or a great deal of) humanitarian support, but the limitations of the agencies will always become apparent. There is little use establishing a high-tech facility if the cultural environment cannot sustain such an installation. Intelligent planning will only come with a broad understanding of the doctrine and requirements of the civilian partners on the humanitarian battlefield. If this dictum is followed, the effectiveness of the military force will be greatly enhanced, and the resultant efficiencies can shorten the deployments and demonstrate to the world how well NATO projects essential Western values.

¹Quoted in Nicolas Morris, "Origins of a crisis: An operation as difficult and complex as any UNHCR has faced," *Refugees Magazine* (issue 116, 1999).

²Cornelio Sommaruga, "Kosovo: All Sides Must Let the Red Cross Work in Kosovo," *International Herald Tribune* (26 May 1999).

³See Richard Caplan, "Kosovo: the implications for humanitarian intervention," *Forced Migration Review* (5 August 1999), for a brief but insightful discussion of the international authorization dilemma.

⁴The Independent International Commission on Kosovo *The Kosovo Report: Conflict, International Response, Lessons Learned* (Oxford: Oxford University Press, 2000), p. 55. This valuable survey and analysis by a group of independent international experts was originally the initiative of the Prime Minister of Sweden, Mr. Goran Persson, who was concerned by the lack of independent analysis of the conflict in Kosovo. The idea was endorsed by the Secretary-General of the U.N., and the commission was established on 6 August 1999 under the leadership of Justice Richard Goldstone of South Africa. This report will hereafter be cited as *KRCIR*.

⁵United Nations High Commission for Refugees, Evaluation and Policy Analysis Unit, *The Kosovo refugee crisis: An independent evaluation of UNHCR's*

emergency preparedness and response (Geneva: UNHCR, February 2000), hereafter cited as *IE-UNHCR*. The international team that supported this initiative was asked to “consider the role and impact of other actors involved in the crisis, to the extent and insofar as they affected UNHCR’s operations”. See endnote 3 for a more complete description of the early NATO actions.

⁶Pierre Krahenbuhl. “Conflict in the Balkans: Human Tragedies and the Challenge to Independent Humanitarian Action,” *International Review of the Red Cross* (Geneva: No. 837, 31 March 2000), p. 15.

⁷*KRCIR*, p. 4. See also James A. Burger, “International Humanitarian Law and the Kosovo Crisis: Lessons Learned or to be Learned,” *International Review of the Red Cross* (31 March 2000), no. 837, p. 129-145. Burger is a retired U.S. Judge Advocate and former IFOR legal advisor. He notes that “the Kosovo conflict was precipitated by a humanitarian crisis of huge proportions...” but raises the question of the extent to which the laws of armed conflict can be applied to an ongoing humanitarian disaster.

⁸As noted in International Crisis Group. *The New Kosovo Protectorate* (ICG Balkans Report no 69, Sarajevo, 20 June 1999), p. 4.

⁹In all references in this paper to Macedonia, or the Republic of Macedonia, we have dispensed with the use of the internationally agreed title and its frightful acronym, the Former Yugoslav Republic of Macedonia (FYROM), in the interests of both space and aesthetics.

¹⁰*KRCIR*, pp. 90-91.

¹¹*IE-UNHCR*, p. 6.

¹²*Ibid.*, p. 18.

¹³*Ibid.*, p. 33.

¹⁴International Council of Voluntary Agencies (ICVA), “The Independent Evaluation of UNHCR’s Emergency Preparedness and Response to the Kosovo Refugee Crisis,” in *Talk Back: The Newsletter of ICVA*, vol 2, no. 1 (18 February 2000).

¹⁵*Ibid.*, p. 34.

¹⁶“UNHCR Representative holds briefing on Kosovo Humanitarian Crisis,” (Washington, DC: National Press Club, 5 May 1999), p. 12 of 13.

¹⁷Larry Minear, Ted van Baarda, and Marc Sommers, *NATO and Humanitarian Action in the Kosovo Crisis* (Providence, RI: Thomas J. Watson Jr. Institute for International Studies, Brown University, Occasional Paper #36, 2000), p. 25.

¹⁸*IE-UNHCR*, pp. 39-40.

¹⁹See U.S. Department of Defense, *Report to Congress: Kosovo/Operation Allied Force After-Action Report* (Washington, DC: 31 January 2000). In a chapter entitled “Why Did Milosevic Capitulate?” (pp. 10-12), DoD analysts note that because Milosevic could not defeat NATO militarily, his only hope was to split the unity of the NATO alliance. This tactic did not work, and in the end, “diplomatic and economic leverage combined with superior military force” brought the crisis to an end.

²⁰U.N. Office for the Coordination of Humanitarian Affairs (OCHA). *Briefing to the Security Council by Under-Secretary-General Sergio Vieira de Mello on the U.N. Inter-Agency Needs Assessment Mission to the Federal Republic of Yugoslavia* (Geneva: OCHA ReliefWeb site, 2 June 1999).

²¹UNHCR. *UNHCR Kosovo Return Plan* (Geneva: OCHA ReliefWeb site, 11 June 1999).

²²Jeffrey Heller, "Kosovo refugees deaf to Clinton pleas," (Reuters, from Stankovic, Macedonia, 23 June 1999).

²³UNHCR. *UNHCR Kosovo Crisis Update: 24 June 1999* (Geneva: OCHA ReliefWeb site, 24 June 1999).

²⁴UNHCR. *UNHCR Kosovo Crisis Update: 30 July 1999* (Geneva: OCHA ReliefWeb site, 30 July 1999).

²⁵Most of the following examples are taken from Larry Minear, et al, *ibid.*, pp. 28-33, and from the author's discussions with NGO officials who have served in Kosovo after the air war.

²⁶See "Prepared Statement of the Honorable William S. Cohen to the Senate Armed Forces Committee Hearing on Operations in Kosovo," (U.S. Senate Testimony, 20 July 1999).

²⁷"U.N. and U.S. military trade charges on Kosovo," (Reuters, 22 July 1999).

²⁸Thomas S. Blanton, ed., "Lessons Learned from U.S. Humanitarian Interventions Abroad," from U.S. Department of State, *Interagency Review of U.S. Government Civilian Humanitarian & Transition Programs, Annex A, Kosovo Case Study* (Washington, DC: George Washington University, National Security Archive Electronic Briefing Book No. 30, April 2000). This unclassified internal State Department document was the result of an interagency study group chaired by USAID's James Michel and the State Department policy planning director, Morton Halperin. The group met between July and December 1999, and the report was drafted in January 2000. The State Department report was obtained by the GW center through the Freedom of Information Act.

²⁹From UNMIK internal documents.

CHAPTER XII

Law and Order in Kosovo: A Look at Criminal Justice During the First Year of Operation Joint Guardian

CPT Alton L. Gwaltney, III¹
Center for Law and Military Operations²

*Only after you have a secure environment, and an effective police force and non-prejudicial justice system in place, can you create the economic instruments necessary for fully functioning societies.*³

When Task Force Falcon entered the province of Kosovo in June 1999 as part of the larger Kosovo Force (KFOR), it was confronted with a law and order mission not faced by U.S. forces since the post-World War II occupation of Germany and Japan.⁴ KFOR and the United Nations Mission in Kosovo (UNMIK), the international civil presence tasked with maintaining civil law and order, executed a law and order mission complicated by the absence of an existing criminal justice system and unforeseeable planning factors. KFOR's public security measures, intended to be short term, continued through the first year of *Operation Joint Guardian*. KFOR's guidance to enforce basic law and order, combined with UNMIK's inability to establish the criminal justice systems necessary to assume the law and order mission, required Task Force Falcon to police criminal misconduct, provide judicial review for those arrested, and establish and run prisons. The success of Task Force Falcon in operating the criminal justice system illustrates the military's ability to adapt traditional combat roles to peacekeeping missions. Task Force Falcon's first year in Kosovo also provides a core set of lessons for future peacekeeping missions containing substantial law and order requirements.

The conceptual framework underlying this overview of Task Force Falcon's law and order mission during the first year of Operation Joint

Guardian is a combination of two models previously used to discuss law and order missions. The first, an analytical framework developed by the Institute for National Strategic Studies (INSS), was used to produce seven case studies of military peacekeeping operations. This model focused on analyzing the background, mandate, mission, coordination, and evaluation of U.S. military actions that included significant law and order missions.⁵

The second model has been described as the three-legged stool of the justice system. The three-legged stool was a graphic used by officials from the United States Agency for International Development (USAID) and the International Criminal Investigation and Training Assistance Program (ICITAP) of the Department of Justice, in conjunction with the Multinational Forces in Haiti, to address law and order challenges during Operation Uphold Democracy.⁶ As reprinted below, the three-legged stool model is used to depict the importance of assessing, concurrently, three elements of a security triad: police, courts, and prisons. It recognizes that the progress in one area, or leg, is ineffective without timely improvements to the other two.



Figure 1. The Three-Legged Stool Model of Police, Courts, and Prisons

This article briefly reviews the public security triad in Kosovo prior to U.S. military entry and then focuses on the various agreements framing KFOR's public security mandate upon entry into Kosovo under U.N. auspices.

Law and Order in Kosovo, pre-June 1999

Since 1989, all branches of the public security triad in Kosovo, as well as many of the Serbian laws, were used as tools for Serbian State control and Albanian oppression. Traditional Western views of law and order as a public service apparatus designed to afford protection to the public were foreign to the citizens of Kosovo. In the months leading up to NATO entry into Kosovo, all public security systems were instruments of concerted violence, intimidation, and brutality that led to the massive refugee crisis in Macedonia and Albania reflected daily in the international media.⁷

Police

The Ministry of Interior Police (MUP) served as the primary law enforcement organization within Kosovo prior to June 1999⁸ and consisted of three subgroups: the regular police (militia), specialized units (PJP), and special anti-terrorist units (SAJ).

MUP numbers in Kosovo increased significantly in February 1998 after the start of the armed conflict with the ethnic Albanian insurgency known as the Kosovo Liberation Army (KLA). The regular police, armed with light machine guns, numbered approximately 5,000 members prior to KFOR's entry. Armed with high caliber weapons, mortars, and armored personnel carriers, the PJP also numbered approximately 5,000 personnel in Kosovo. The SAJ, heavily armed with an arsenal that included T-55 tanks, armored vans, and anti-aircraft guns, numbered around 500 members in Kosovo prior to June 1999.

The MUP was considered an important element to the political survival of Yugoslav President Slobodan Milosevic's and received greater resources than the regular Army.⁹ The MUP was accused of widespread abuses and atrocities, including summary executions, arbitrary and mass arrests, kidnapping, torture, rape, and looting. One report detailing Kosovo police activities remarked that "torture and ill-treatment... was widespread and an apparently integral element of police conduct..."¹⁰

In conjunction with the regular Yugoslav Army, the MUP conducted offensive military operations against the insurgent KLA. Under the guise of counter-insurgent military operations, the MUP frequently expelled entire Albanian communities from Kosovo.¹¹ The final

agreements providing the framework for the international security presence in Kosovo required all MUP to withdraw from the province.¹²

Courts

With the revocation of Kosovo autonomy in 1989, politically motivated and ethnically one-sided appointments, removals, and training resulted in the replacement of Albanian judges and prosecutors across the province. This judicial cleansing led to a judiciary in which, out of 756 judges and prosecutors in Kosovo, only 30 were Albanians.¹³ As a direct consequence, judicial impartiality was questionable, and the Serb-dominated Kosovo judiciary was viewed as another instrument of the Federal Republic of Yugoslavia (FRY) executive's campaign of repression, rather than as an independent branch of government.¹⁴ As a secondary consequence, the pool of trained Albanian legal professionals diminished as Albanian jurists were unable to practice their profession.

Serb judges in Kosovo were called upon to enforce often vague and discriminatory laws used to penalize a wide range of activities including criminal associations and terrorist acts throughout Kosovo.¹⁵ The Serb judges' broad interpretation of accessory statutes¹⁶ led to the criminal prosecution of individuals for delivering humanitarian supplies and providing medical care to inhabitants of KLA controlled territories.¹⁷ Although it is likely that some detained individuals did, in fact, cooperate with the KLA, the charge of "terrorism cast a wide legal net around many ethnic Albanians who [did] not have contact with the Albanian insurgents."¹⁸

Judicial monitors in Kosovo during the year prior to NATO intervention reported that Serb judges ignored evidentiary and procedural rules, conducted trials without the presence of defendants, and handed out substantially harsher penalties for Albanians convicted of crimes. For high-profile cases of Albanians accused of nationalist activities, judges of questionable independence from the police and prosecution were sent directly from the Serbian capital of Belgrade to preside.¹⁹ The abuses of the judiciary during the ten years prior to KFOR entrance into Kosovo undermined the Albanian's belief in the courts as a law and order apparatus guaranteeing justice and fueled the flames of revenge that permeated the entire region.

Prisons

Prisons within Kosovo were another public security system subject to widespread abuses and discrimination. Detainees brought into the pre-KFOR prison system within Kosovo could expect to be beaten frequently and severely. Many Albanians were placed in the prison system without being charged or tried, interrogated for weeks, and then released or killed.²⁰

Conditions in the prisons were exceptionally poor. Cells were overcrowded, detainees were deprived of water and food, and sanitation facilities were non-existent. Because many of the prisons were co-located with MUP stations or army encampments, they suffered damage during the NATO air campaign. Prisons that were not damaged or destroyed during the bombing effort were looted by withdrawing Serbs on the eve of KFOR's entrance into Kosovo.

Large prison facilities in Istok, Lipljan, Pec, and Pristina existed in Kosovo prior to KFOR entry into the province, but were located outside the area that the U.S. forces occupied. Local police stations and courts often contained small prison facilities, and two of these facilities were located in the U.S. Area of Responsibility (AOR) at Urosevac and Gnjilane. Both, however, were in extremely poor condition and unusable as jails upon U.S. KFOR arrival in Kosovo.

The Kosovo Force Law and Order Mandate

NATO's air campaign against the Federal Republic of Yugoslavia ended with the signing of the Military Technical Agreement (MTA) between the International Security Force (KFOR) and the governments of the Federal Republic of Yugoslavia and the Republic of Serbia on June 9, 1999.²¹ The MTA provided Serbia's permission for KFOR to enter Kosovo for peacekeeping operations. In conjunction with the signing of the MTA, the United Nations Security Council adopted Security Council Resolution 1244 (UNSCR 1244), authorizing an international security presence (KFOR) and an international civil presence (UNMIK) within Kosovo.²² Finally, the Undertaking of Demilitarization and Transformation of the Kosovo Liberation Army (hereinafter Undertaking) served as the insurgent forces' recognition of the end of hostilities and the legitimacy of the peacekeeping operation.²³

Specifically enumerated within UNSCR 1244 as a KFOR responsibility was the task of “ensuring public safety and order until the international civil presence [could] take responsibility for this task.”²⁴ The importance of the law and order mission was further emphasized in the Report of the Secretary General on the United Nations Mission in Kosovo submitted on July 12, 1999. In this report, the Secretary General noted that “the security problem in Kosovo is largely a result of the absence of law and order institutions and agencies.... The absence of a legitimate police force, both international and local, is deeply felt, and therefore will have to be addressed as a matter of priority.”²⁵

The authority and requirement for KFOR to undertake the police functions within Kosovo were clearly laid out in the Secretary General’s description of UNMIK’s three-phased policing plan for Kosovo. In the first phase, wrote the Secretary General, “KFOR will be responsible for ensuring public safety and order until the international civil presence can take responsibility for this task.... In the second phase, once UNMIK has taken over responsibility for law and order from KFOR, UNMIK civilian police will carry out normal police duties and will have executive law enforcement authority.”²⁶

UNSCR 1244 called for the deployment of international police (UNMIK-P) and the creation of local police forces (KPS) under the control of the civil presence. In his report to the United Nations, the Secretary General described the build-up of international police and creation of a local constabulary as the “two main goals...defin[ing] UNMIK’s law and order strategy in Kosovo.”²⁷

Echoing the Secretary General’s comments, the Special Representative of the Secretary General (SRSG) in Kosovo issued a statement of the right of KFOR to apprehend and detain persons suspected of having committed offenses against public safety and order. In that statement, Sergio Vieira de Mella, then acting SRSG in Kosovo, stated that “KFOR had the mandate and responsibility to ensure both public safety and order...until UNMIK itself can take full responsibility.”²⁸

While the policing mandate of KFOR seems clear in the documents providing the framework for Operation Joint Guardian, the sole document available to KFOR and Task Force Falcon for planning and preparing for the KFOR mission was the Rambouillet Accords: Interim Agreement for Peace and Self-Government in Kosovo (hereinafter

Rambouillet Accords), which provided a much different set of planning factors than those faced by Operation Joint Guardian under the MTA.

In February 1999, the Albanian leaders of Kosovo, including the KLA and the LDK (the predominate Albanian political party), and representatives of The Federal Republic of Yugoslavia met in Rambouillet, France to negotiate a peace settlement. The Rambouillet Accords were designed to serve as a cease-fire between the KLA and the Yugoslav government that would provide for the entrance of U.N. peacekeepers for monitoring and enforcing the cease-fire and for a civil presence for reconstruction. Although this agreement was not executed, its importance was not diminished, as subsequent KFOR framework documentation specifically contained the phrase “taking full account...of the Rambouillet Accords.”²⁹ The drastic change in circumstances on the ground in Kosovo during the NATO intervention led to a shift in policy between the February Accords and the June MTA. While providing the underlying framework for the ultimate KFOR mission, the Rambouillet Accords contained provisions different from the settled-on terms of the three documents dictating the KFOR mandate. These differing provisions in the Rambouillet Accords and the MTA significantly affected the law and order mission of KFOR.

Framework for International and Communal Police Under Rambouillet and MTA/UNSCR 1244

The powers of arrest and detention by KFOR were not specifically enumerated in the Rambouillet Accords, which limited these powers to communal police (the remaining MUP), assisting international police, and border and customs officials. The Rambouillet Accords contained broad language that could have been interpreted to allow for arrest and detention by KFOR, if necessary.³⁰ The main obligations of KFOR under the Rambouillet Accords, however, extended to enforcing the cessation of hostilities, contributing to a secure environment, and protecting itself, the Implementation Mission, International Organizations and Nongovernmental Organizations.³¹

Both the Rambouillet Accords and the KFOR mandate under the MTA and UNSCR 1244 called for the deployment of international civilian police (UNMIK-P). Moreover, the need for international police became much more significant in Operation Joint Guardian as the result of a shift in policy following the breakdown of the Rambouillet negotiations.

The Rambouillet Accords called for a withdrawal of some members of the Ministry of Interior Police (MUP) and an overall reduction in the numbers of MUP remaining in Kosovo. Within 5 days of Entry into Force (EIF) of the Rambouillet Accords, all MUP units not assigned to Kosovo prior to February 1, 1998, were required to withdraw all personnel and equipment to locations in Serbia. The remaining MUP forces would have been required to withdraw to cantonment areas within Kosovo and to complete a phased drawdown. Within 20 days of EIF, all MUP offensive assets³² would have had to be withdrawn. The drawdown would eventually have required a 50 percent reduction in force within 2 months, a drawdown to 2,500 total troops within 4 months, and a complete disbanding of troops within 1 year.³³

Significantly, the MUP forces remaining during this drawdown would have had the authority to conduct civil police functions. This would have included the power of arrest and detention, under the supervision and control of the Chief of the Implementation Mission (CIM), an appointee of the Organization for the Security and Cooperation in Europe (OSCE).³⁴

Unlike the Rambouillet Accords, the MTA required a phased, complete withdrawal from Kosovo of all MUP forces within 11 days of the signing of the agreement. All military and police forces of the FRY were required to withdraw from the area in which the United States would operate, within 6 days of the signing of the MTA. The complete withdrawal requirements of the MTA thus left Kosovo devoid of trained police forces.

Under the Rambouillet Accords, a civilian police force was to be established concurrently with the drawdown of the MUP forces, a communal police force numbering 3,000 members. The communal police force would have assumed all police functions within Kosovo. Members of the MUP were eligible to become members of the communal police after a vetting process. The partial withdrawal of MUP under the Rambouillet Accords, combined with the large population of eligible Albanians in the province, would have provided OSCE with a broad, ethnically diverse pool of applicants from which to select a communal police force.

The mission of establishing a communal police force set forth in the Rambouillet Accords was similar to the mission undertaken by UNMIK and OSCE to establish the multi-ethnic KPS within Kosovo after the

implementation of the MTA. The KPS was intended to eventually become the police force of Kosovo.

The Police Build Up in the UNMIK Mission

Despite the U.N.'s urgent call for upwards of 3,100 international police to assist with the UNMIK mission, the international community did not meet the U.N.'s request for almost a year. On June 27, 1999, the first international police arrived in Kosovo, from Bosnia, to serve as an advance party for the UNMIK-P mission. The first joint KFOR/UNMIK-P patrol did not occur until August 9, and UNMIK-P did not take police responsibilities for a city within Kosovo until August 27 when they assumed policing duties in the provincial capital of Pristina, located in the British AOR. At that time, UNMIK-P in Kosovo numbered 774 officers, with 663 of these in Pristina.

The number of UNMIK-P in Kosovo did not surpass 1,000 police officers until September 7, almost 3 months into the KFOR mission in Kosovo. Even then, however, the U.S. sector saw only 35 of these officers—all located in Gnjilane. On October 27, 1999, the United Nations Secretary General asked for an additional 1,600 international police to serve as UNMIK-P, bringing the total number of international police requested for the UNMIK mission to 4,700. By October 27, 1999, UNMIK-P assumed police primacy in Prizren, a city within the German AOR, and by December 1, 1999, UNMIK-P assumed responsibilities for the operation of a detention center also located in Prizren.

At the 1-year mark, UNMIK-P numbered just over 3,600 throughout Kosovo. At that time, the international police had assumed complete police responsibilities for only 2 cities, Pristina and Prizren. Within the U.S. area, UNMIK-P had assumed investigative primacy for the city of Gnjilane. Non-investigative law enforcement responsibilities within Gnjilane, and all police responsibilities throughout the remainder of the U.S. AOR, remained with Task Force Falcon.³⁵

The establishment of the Kosovo Police Service also proceeded at an extremely slow pace. Under the direction of UNMIK, members of the KPS were selected from applicants across Kosovo. The few available Serb applicants hampered this selection process, designed to provide a fair representation of all ethnic groups in Kosovo. All members selected for the KPS attended the Kosovo Police Service School (KPSS), run by

OSCE. Training at the KPSS consisted of 9 weeks of instruction in patrolling, firearms, defensive tactics, police skills, crime investigation, and traffic control. At the completion of KPSS, members of the KPS were sent to the field for an additional 19 weeks of training along side UNMIK-P. After completing this field training, KPS members were given police authority. The first class of 173 KPSS students graduated on October 18, 1999. Three additional classes were to graduate before the KFOR mission's 1-year anniversary: a class of 176 on February 18, 2000; a class of 230 on April 22, 2000; and a class of 218 on May 19, 2000. Although the exact percentage of the KPS graduates operating within the U.S. AOR is unknown, those KPS personnel provided little relief to the overall Task Force Falcon policing responsibilities.³⁶

A Comparison of the Police Build Up Accomplished During the UNMIK Mission and the Police Personnel that were to be Available under the Rambouillet Accords

A comparison of numbers alone does not explain all of the significant differences between the potential peacekeeping mission envisioned under the Rambouillet Accords and the actual peacekeeping mission dictated by UNSCR 1244 and the MTA. Had Rambouillet become the framework for a Kosovo mission, one million Albanians would not have been displaced from their homes, only to return to force out hundreds of thousands of Serbs. The Kosovo population and infrastructure would not have been subject to a NATO air campaign. The physical, emotional, and political climate of the region would have, in all likelihood, been entirely different. Nevertheless, a comparison between the numbers of international and local police within Kosovo during the first year of the KFOR mission and the potential numbers that may have been available under the Rambouillet Accords provides a stark illustration of the policing vacuum faced by KFOR.

The police buildup during the first year of the KFOR mission is displayed in Table 1.

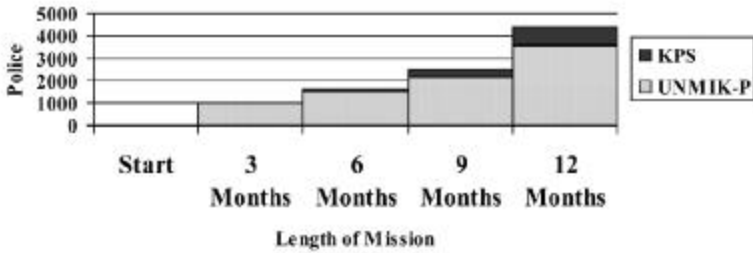

Table 1. Police Build-up During the First Year

An estimated number of police that were to be available during the first year in Kosovo under the Rambouillet Accords is represented graphically in Table 2.³⁷

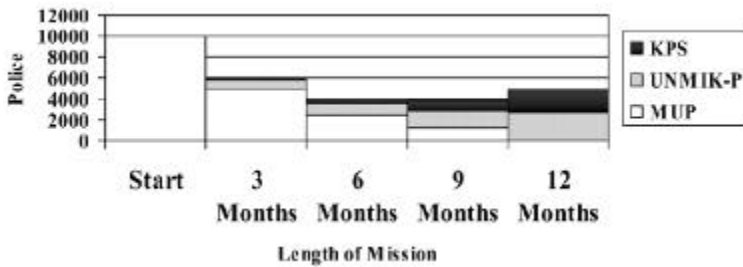

Table 2. Police Available During First Year

Table 3 illustrates the comparison of police that were to be available in Kosovo under the Rambouillet Accords and the actual number available under the MTA.

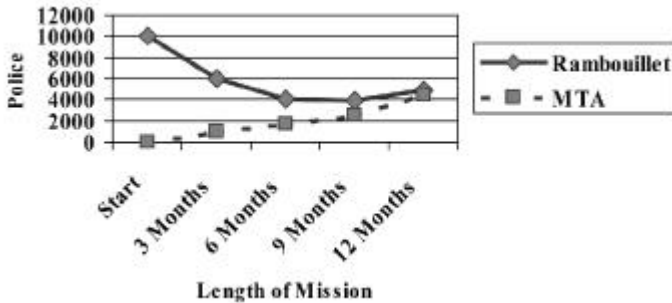

Table 3. Rambouillet Accords Police Estimate vs. MTA Police Availability

The complete withdrawal of the MUP, the slow deployment of UNMIK-P, and the slow establishment of the KPS combined to create a policing deployment gap that left KFOR as the only policing authority in most of Kosovo during the entire first year of operations.

Courts

The law and order vacuum in Kosovo extended beyond the absence of police to a complete absence of any competent judicial authority. UNMIK's efforts to establish a judiciary were hampered significantly by the scarcity of professional and lay jurists. Because of the exodus of Serbs from Kosovo, most of the Serbian-trained judiciary had left the province. The few judges who initially remained ultimately left because of security concerns. The remaining Albanian jurists were without judicial experience and lacked training in basic human rights. UNMIK also had few opportunities to select Serb lay judges (the rough equivalent of a jury member in U.S. criminal law) as a result of the Serb exodus following KFOR's arrival.

While UNMIK believed that only a multi-ethnic judiciary should serve Kosovo, it found this aspiration almost impossible to attain. The lack of Serb participation in the judicial process caused the Serbian population to question the system's fairness, and the actions of the Albanian-dominated Kosovo judiciary sometimes caused the international community to question the system's fairness as well.³⁸

In planning for the KFOR mission under Rambouillet, no one expected to confront a vacuum of judicial experience. While the judiciary had been an instrument of ethnic abuses in the past, the international community believed, through vetting and training, a multi-ethnic and just system could be established. This system would have included practicing Serb legal jurists, combined with the Albanian jurists denied the opportunity to practice during the previous 11 years. Moreover, the existence of a basic legal infrastructure would have enabled the criminal process to continue to operate without significant delay after KFOR's entrance. This would have provided continuity and prevented the substantial backlog in the criminal docket that ultimately hampered the UNMIK effort.

UNMIK's plan to revive the judicial system was slow in developing and often confusing. UNMIK's charter in judicial affairs was to establish a

“fully functioning independent and multi-ethnic judicial system,” as this charter was seen as the only solution to “existing security concerns in Kosovo” and as a tool for building public confidence in the UNMIK mission.³⁹ As a stopgap measure, the SRSG, between June 30, 1999 and September 1, 1999, appointed judges and prosecutors to an Emergency Judicial System (EJS). All SRSG appointees had served previously as judges or prosecutors, but most appointees had not practiced during the past 10 years. The SRSG made attempts to appoint a multi-ethnic EJS, but Serbs refused to participate in the process.⁴⁰

The primary mission of the EJS was to review the pre-trial detentions that mounted after KFOR’s entry into Kosovo. It both conducted the initial detention hearings and reviewed the continued detention for criminal suspects of serious crimes.⁴¹ At the 6-month mark, the SRSG had appointed 30 criminal law judges and 12 prosecutors across Kosovo to participate in the EJS. Prior to the KFOR entry into Kosovo, 756 judges and prosecutors had served as participants in the Kosovo judiciary.

While the EJS was able to conduct actual criminal trials in one area, their efforts in the U.S. AOR were limited to pre-trial case investigation and continued pre-trial detention review. However, significant material constraints and confusion over applicable laws hampered even this limited task of pre-trial criminal process.

The most significant obstacle to the efficient functioning of the EJS was the question of the law applicable in Kosovo.⁴² The first UNMIK Regulation, passed on July 23, 1999, provided that the law applicable in Kosovo would be the law in place prior to March 24, 1999, the start of the NATO intervention.⁴³ The judges appointed to the EJS uniformly rejected this provision, opting to apply the Kosovo Criminal Code, annulled by Serbia in 1989 when Kosovo autonomy was revoked. This left both law enforcement officials and international lawyers uncertain of the applicable body of law. Adding to the confusion was the SRSG’s attempt to remedy the situation by repealing sections of UNMIK Regulation 99/1, and allowing the use of the previously annulled Kosovo Code or laws enacted after 1989, if those laws provided additional protections for detainees.⁴⁴

Within the Task Force Falcon AOR, no EJS teams were appointed. A mobile detention team from Pristina began regular hearings on pre-trial detention cases in the U.S. AOR on July 13, 1999, only 3 weeks after Task Force Falcon arrested its first long-term pre-trial detainee.⁴⁵ This mobile

team consisted of an Investigating Magistrate, a prosecutor, and two or three assistants responsible for clerical work. U.S. forces provided transportation, logistics, and interpreter support for the hearings.

None of the previously existing court buildings were capable of hosting the EJS in the U.S. AOR, and because the United States had established a detention facility on its primary base camp, the EJS conducted detention hearings at Camp Bondsteel three times a week. The hearings were conducted in a general purpose medium-sized tent, furnished with two large folding tables, two field desks, two folding card tables, four benches, and four folding chairs.

Just as U.S. soldiers filled the law enforcement gap resulting for the delay in the deployment of international police, U.S. legal personnel were tasked to fill the judicial gap.⁴⁶ This gap, created by the delay in appointing the EJS, and propagated by the significant backlog of cases, required U.S. legal personnel to continue to assist in the pre-trial judicial process throughout the entire first year of operations.

The EJS in Kosovo continued to serve as the only civilian court system until January 14, 2000 when the SRSG appointed permanent judges and prosecutors for the courts of Kosovo. After the judicial swearing in, courts in Gnjilane and Urosevac, both within the U.S. AOR, reopened. These courts, for the first time since U.S. KFOR's entrance into Kosovo, moved beyond pre-trial detention review and, in the U.S. sector, tried the first criminal case in the middle of February, 8 months after the United States entered Kosovo.⁴⁷ The same types of problems faced by the EJS hampered the permanent judicial system. Of the 280 professional judges, lay judges, and prosecutors sworn into service, only 17 were minorities, and only two of these were Serbs.⁴⁸

The full-time judiciary also faced funding, supply, and support-staff shortages. Combined, these problems further delayed the efficient handling of criminal trials. Between February and June, the judiciary completed work on only six felony-level criminal trials within the U.S. AOR. The judiciary's inability to try any criminal cases within the first 7 months, and its inability to efficiently try criminal cases within the first year, led to significant criticism of this leg of the public security mission. This inability to try criminal cases eroded the local citizen's faith in the ability of KFOR and UNMIK to establish justice in Kosovo.⁴⁹ More importantly, this delay prevented the interim administration from holding criminals accountable for their actions when crime rates were

at their highest and at a time when a strong criminal justice response was needed to establish credibility for the overall mission.

Prisons

An agreement at Rambouillet would have prevented NATO action in Kosovo that led to the extensive damage to prisons caused by the Allied bombing campaign. More importantly, corrections police, under international supervision, could have continued to run the existing facilities. These circumstances would have provided the international community with both the physical structure and the inner-workings of a correctional system that could have prevented the necessity for KFOR's to establish and run long-term detention facilities.

Within the U.S. AOR, the detention situation was exacerbated by the lack of an existing large prison facility. Only small detention centers attached to local police stations were available in the Task Force Falcon area. As discussed below, KFOR opted not to establish a centrally located and jointly-run detention facility. It was left to the subordinate Task Force headquarters to establish detention centers within their respective AORs. Faced with no other option, Task Force Falcon constructed a facility for pre-trial detention on Camp Bondsteel.

Delays in the deployment of adequate police to the region led to delays in establishing permanent prison facilities. At the first anniversary of the KFOR operation, UNMIK-P oversaw detention facility operations in Prizren (100-inmate capacity), located in the German AOR, and in Lipjlan (46-inmate capacity), in the British AOR. Soon thereafter, UNMIK-P opened a 520-inmate detention facility in Istock, a city located in the Italian AOR.⁵⁰ Within the U.S. AOR, UNMIK-P reopened the small detention area attached to the Gnjilane police station (approximately 30-inmate capacity) in May 2000. All detainees accused of serious crimes and all Serb detainees continued to be transferred to the Camp Bondsteel Detention Facility.

The Kosovo Force Law and Order Mission

Police

The KFOR mandate under UNSCR 1244 and the broad provisions of the MTA combined to provide the basis for the KFOR law and order mission

in Kosovo. Contained within COMKFOR's order to all of the subordinate Multinational Brigades was the mission to "[i]nitially enforce basic law and order, transitioning this function to the to-be-formed designated agency as soon as possible." Within the U.S. KFOR AOR, the "to-be-formed designated agency" would not be prepared to accept the policing mission during the entire first year of the KFOR mission.

The order to enforce basic law and order resulted in KFOR soldiers becoming the police force of Kosovo in order to fill the existing law enforcement gap. This was a vastly different and more difficult mission than envisioned under the Rambouillet framework. Policing under the Rambouillet Accords would have fallen upon three policing entities: an International Police force, a new Kosovo civilian police force, and the MUP personnel who remained in place during the drawdown. Policing activities under the MTA fell solely upon KFOR, until a point in time at which UNMIK could establish an international police presence or local force.

While KFOR recognized that the powers of arrest and detention were generally to conform to the FRY standards,⁵¹ the leadership also understood that KFOR was incapable of replicating the FRY legal infrastructure and criminal procedures for law and order. As a result, KFOR determined that internationally respected standards of law enforcement and detention, in keeping with the troop-contributing nations' own relevant procedures would provide adequate due process protections to the citizens of Kosovo. Initially allowing troop-contributing nations to apply familiar law and procedures served to reduce start-up delays that would have inevitably resulted from any attempt to promulgate a centrally run policing process. Even though detainees in the Italian AOR received Italian Process while detainees arrested in the U.S. sector received American Process, it was KFOR's belief that dealing with the issue of arrest and detention under the general legal framework of each troop-contributing nation was the only possible way to addressing the initial law enforcement gap.⁵²

U.S. soldiers were instructed to detain persons who committed criminal misconduct under a familiar standard.⁵³ During each of the 1,300 patrols that U.S. soldiers conducted per week in Kosovo, arrest decisions were based upon the U.S. Uniform Code of Military Justice (UCMJ). If soldiers witnessed an act that would be a crime under the UCMJ, they arrested the wrongdoer. Crimes under the military code were augmented by mission specific crimes, such as weapons, uniform, and curfew violations.⁵⁴

Soldiers were also authorized to arrest or detain local citizens who they considered a threat to the military or to the overall mission.⁵⁵

Task Force Falcon Military Police (MP) and Criminal Investigation Command (CID) investigators were able to respond to only the most serious crimes; therefore, soldiers assigned to combat units were called upon to conduct basic criminal investigations in conjunction with detentions and arrests.⁵⁶ These soldiers had little or no law-enforcement or investigative training as the basic doctrine and mission essential tasks of combat units do not address law enforcement and criminal investigation. To assist soldiers with these unfamiliar investigation missions, the Task Force Falcon Legal Section created situational vignettes for basic law enforcement training. The training vignettes covered the topics of arrest, search, use of force, probable cause, and basic investigative procedures. Soldiers were thus instructed to take statements and document evidence seized at crime scenes for further prosecution efforts.

Task Force Falcon altered typical military missions so as to include special law enforcement instructions on confronting criminal misconduct. Intelligence gathering assets were focused on both the potential military threat and the criminal threat within the Task Force AOR. Field Artillery units sometimes fired night illumination missions to assist the law enforcement effort. Civil Affairs and Psychological Operations soldiers furthered this effort by explaining KFOR's policing policies to the local population. Specialized policing units from coalition countries were also attached to the Task Force to assist with the mission. In short, every staff section of Task Force Falcon was engaged in assisting the law and order mission.

When patrols arrested local citizens for committing criminal offenses, they delivered initial criminal packets and evidence, with the detainees, to the U.S. detention facility at Camp Bondsteel. At Camp Bondsteel, Task Force Falcon lawyers reviewed each detainee's case to recommend whether continued pre-trial detention was warranted and to ensure that the case file contained information sufficient enough to pass the cases to the civil prosecution system, once this system was established.

Courts

1. Upon Entry

KFOR's decision to decentralize the criminal justice standards required that the members of Task Force Falcon craft an orderly, principled, pre-trial detention review system that would pass the scrutiny of independent observers, the press, and a local population unfamiliar with the theory of due process. In the early stages of the deployment, the Judge Advocates of Task Force Falcon functioned as the only judicial review mechanism available for local pre-trial detainees. International standards, the Law of the Federal Republic of Yugoslavia, and U.S. law prescribed procedural safeguards for civilians taken into pre-trial detention. The Judge Advocates of Task Force Falcon drew on these source documents, lessons learned from previous U.S. deployments, and their own previous criminal law experiences to establish a thorough system of review for every detainee of Task Force Falcon.⁵⁷

Guidance from COMKFOR concerning "continued pre-trial detention" enabled USKFOR to apply standards similar to those found in the Uniform Code of Military Justice. Specifically, within 48 hours of detention, Task Force Falcon would hold a hearing to determine whether continued detention was warranted.⁵⁸ This hearing was presided over by a Judge Advocate serving as a Magistrate.

In considering whether further pre-trial detention was warranted, the Magistrate would review the case file to determine whether:

1. An offense had been committed that would be triable by court-martial if it had been committed by a person subject to the UCMJ or if a mission-specific crime had been committed;
2. The person detained committed the offense; and
3. Continued detention was required by the circumstances.

To determine whether detention was required by the circumstances, the Magistrate would first have to determine whether:

1. The individual was armed and if his release would threaten civic order;

2. The individual posed a threat to KFOR, other protected persons, key facilities, or property designated mission-essential by COMKFOR;
3. The individual had committed serious criminal acts (defined as homicide, aggravated assault, rape, arson, robbery, burglary, or larceny); or
4. The individual had valuable information pertaining to individuals not yet detained to whom one or more of the above three stated grounds applied.⁵⁹

The Magistrate would also consider whether the detainee posed a risk to flee Kosovo in order to escape prosecution, and whether the detainee would attempt to intimidate witnesses or obstruct justice.

Before and during the hearing another Judge Advocate was detailed to collect independent information and articulate the detainee's argument against further detention. This Judge Advocate, the Command Representative for the Detainee, would assist the detainee in rebutting the Command's grounds for continued detention. The detainee was also given the opportunity to address the Magistrate through an interpreter and to explain why continued detention was not warranted.

If the Magistrate believed that continued detention was warranted, he would recommend that the Task Force Falcon Commander order continued detention. If the Magistrate believed the standards for continued detention had not been met, he recommended that the Task Force Commander order release. The Task Force Falcon Commander personally reviewed all continued detention hearing recommendations during the first month of the mission. On July 13, 1999, the EJS began conducting hearings for detainees held by USKFOR. By this date, Task Force Falcon had detained a total of 27 Kosovo citizens. The Task Force Commander approved continued pre-trial detention for fourteen of those detainees.

2. Establishment of Emergency Judicial System

As the EJS became established, the Task Force pre-trial confinement procedures experienced subtle changes that, while continuing to protect the rights of detainees, also recognized that local systems that were coming into place to protect detainees' rights. The magistrate tasked

with reviewing continued detention began conducting the initial hearings entirely on paper, as detainees would receive a hearing in front of a Kosovar Investigating Magistrate should the Military Magistrate consider further detention warranted. The Commander's Representative for the Detainee was no longer needed, as detainees had access to defense attorneys. Additionally, the Task Force Commander delegated his continued detention authority to the Chief of Staff and the Provost Marshal, depending upon the severity of the charges. The Commander, however, maintained review authority over detainees suspected of war crimes and acts aimed at KFOR soldiers.⁶⁰ When it became apparent that criminal trials were not going to be conducted until some time in the significant future, detainees suspected of minor crimes could be ordered released prior to the Magistrate conducting a review of the detainee's case.⁶¹

When the EJS became operational in the middle of July, cases of continued detention were turned over to the EJS prosecutor for his introduction of those cases into the Kosovo criminal system. Continued detention decisions by the EJS were based entirely upon the criminal laws and procedures of Kosovo.⁶² Criminal procedures of Kosovo allowed for the Kosovar Investigating Magistrate to order continued pre-trial detention for up to 30 days. Detention for greater than 1 month had to be approved by a three-judge panel, and cases that the EJS prosecutor and Investigating Magistrate believed to require pre-trial detention beyond 3 months had to be reviewed by the Kosovo Appeals Court. Existing Kosovo criminal procedure did not allow for continued pre-trial detention beyond 6 months.⁶³ To accommodate continuing pre-trial detention beyond the 6-month period, the SRSG created the Ad Hoc Court of Final Appeal⁶⁴ and empowered the court to order continued pre-trial detention for up to 1 year.⁶⁵

Because an order to release a detainee from continued pre-trial confinement was tantamount to a release from prosecution,⁶⁶ all release orders of the EJS had to be delivered to the U.S. Magistrate for action. The Magistrate reviewed all cases in which the EJS had ordered release and made recommendations to the appropriate Task Force Falcon release authority. The U.S. military release authorities for EJS-ordered releases were the same authorities designated to review U.S. Military Magistrate recommendations for release after initial detention hearings. In practice, this method required Task Force approval for all releases, once detainees entered the Camp Bondsteel detention facility.

On occasion, the military release authority determined that detainees ordered released by the EJS should remain in continued pre-trial detention. When this occurred, the Military Magistrate discussed the continued detention with the Kosovar Investigating Magistrate and prosecutor in an attempt to have them revoke the release order and order continued detention. When continued detention could not be secured through negotiation with the EJS, the Task Force Falcon Commander would appeal to the Commander, KFOR (COMKFOR), to order continued pre-trial detention.

The COMKFOR Hold, as this appeal came to be known, was developed in response to a U.S. request to approve the continued detention (despite an EJS ordered release) of two Serbian males who had engaged in a gun battle with U.S. forces in late June 1999. COMKFOR's legal advisor, after detailing provisions of the MTA and UNSCR 1244 that he believed imbued COMKFOR with the authority to order continued detention, despite the issuance of a release order from the interim civilian judicial system, recommended that COMKFOR exercise this authority and order continued pre-trial detention.⁶⁷ COMKFOR's approval of continued detention in this early case completed the criminal procedure framework applicable to detainees held in the U.S. KFOR AOR for the first year of Operation Joint Guardian, illustrated in Figure 2.

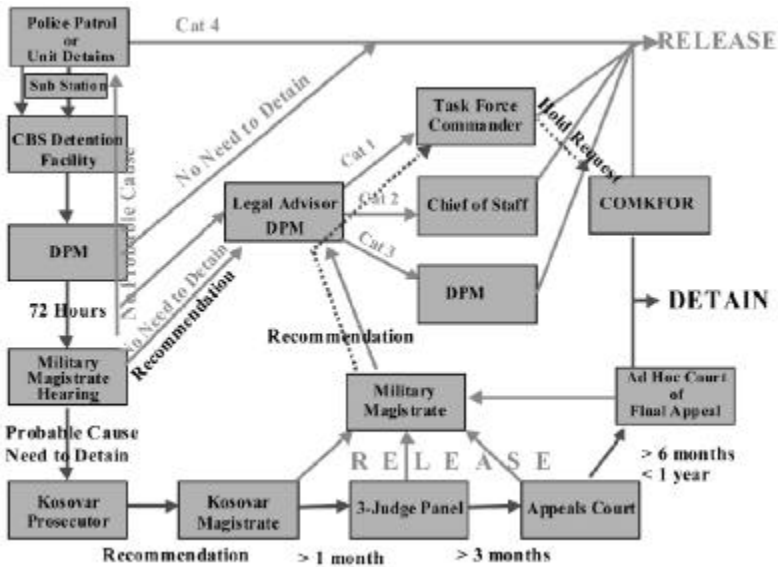

Figure 2. Criminal Procedure Framework in the U.S. AOR

Other changes in the Task Force detention procedures occurred as a result of the establishment of the EJS. The Task Force Magistrate continued to conduct an initial continued detention hearing prior to turning a case over to the EJS prosecutor. However, the 48-hour time limit was relaxed to 72 hours in order to bring it in line with what the Task Force believed to be existing local law.⁶⁸ The standards for pre-trial detention review remained the same, but the Magistrate exercised additional discretion in determining whether the severity of the charges warranted continued detention. Because of limited detention space, the recognition that criminal trials were months away, and the already full pre-trial dockets of the EJS, detainees accused of minor crimes were often ordered released prior to being sent to the EJS for action. Also, as a result of some questionable decisions made by the EJS, the ethnic background of a detainee played a role in any Task Force decision to transfer the case into the EJS, as well.

Shortly after the EJS became operational, questions arose over ability of the EJS to provide equal protection for Serb minorities under the Code, and a disparity in the treatment of detainees of different ethnic backgrounds became apparent. Years of physical and legal oppression by the Serbian Government of Kosovar Albanians may have led to resentment on the part of the newly appointed EJS, which was predominately Albanian.⁶⁹ Alternatively, the Albanian EJS may have rightly believed that all Serb detainees were a flight risk, as thousands of Serbs left Kosovo in the first months following the entry of KFOR. Irrespective of the rationale, however, a pattern developed that resulted in the common continued pre-trial confinement of Serb detainees and the release of Albanians accused of similar misconduct.⁷⁰

Because the result of release from pre-trial detention was, in essence, release from prosecution, the actions of the EJS freed Albanians accused of the same criminal misconduct for which Serbs were detained and prosecuted. Recognizing this, the JA Magistrate reviewing initial pre-trial confinement was left with the options of sending a Serb detainee into the EJS, knowing that lengthy pre-trial confinement and prosecution was imminent, or recommending release, if only to ensure the equal treatment of Serb and Albanian detainees.

The establishment of the EJS also raised the need for logistical support to the court system. If the Kosovar Investigating Magistrate needed to speak with witnesses, he would coordinate with the U.S. Magistrate in order to

have the witnesses brought to Camp Bondsteel for interviews. The U.S. Magistrate would then work with the staff officer responsible for current operations in order to ensure the proper unit was tasked to locate the witnesses and transport them to Camp Bondsteel for the EJS hearing.

EJS hearings were held in a medium-sized military tent inside the Camp Bondsteel Detention Facility. Task Force Falcon provided an additional tent so as to allow detainees to meet with their attorneys before and after the EJS hearings. The Task Force also provided interpreters for the hearings when U.S. soldiers were required to provide testimony. The transition from the EJS to a permanent judicial system also led to additional changes in the pre-trial detention procedures of the Task Force.

3. Permanent Judiciary

The establishment of a permanent judiciary in January 2000 was a significant step in the civilian administration's efforts to create a Kosovar-run system of justice. However, rather than easing the burden on USKFOR, the appointment of judges and prosecutors within the U.S. AOR increased the tasks involved in supporting the judicial mission.

The Task Force Magistrate continued to review new cases of pre-trial detention. Though the crime rates had subsided over the course of 7 months, there remained a significant number of new detainees per week. In addition to effecting coordination for new detentions, the Magistrate was responsible for coordinating with the newly appointed judiciary for criminal trials of long-term pre-trial detainees. Criminal trial courts were established by the SRSG in Urosevac, Gnjilane, Vitina, and Kamenica.⁷¹ As a result, the U.S. Magistrate had to coordinate with multiple prosecutors and judges for pre-trial and trial matters. Because court matters were now being handled in multiple locations, more than one Task Force Judge Advocate was called upon to assist the judicial mission.

Significant Command and international interest in the criminal trials required that a Task Force representative attend the trials. This mission typically fell to the Military Magistrate and Provost Marshal, who observed and monitored the criminal proceedings that were often multiple-day events slowed by archaic court equipment and the necessity to translate the proceedings into no fewer than two languages.

Other staff sections and line units also gained additional responsibilities as a result of the appointment of a permanent judiciary. Courthouses

and judges required protection. During the time that the EJS held hearings within Camp Bondsteel, protection requirements posed a minimal burden. However, the establishment of a permanent judiciary, working in various courthouses within the AOR, in locations lacking an established UNMIK-P presence, required that soldiers provide courthouse and judicial protection.

The advent of a permanent judiciary and criminal trials required Task Force Falcon to transport detainees from the detention facility on Camp Bondsteel to courthouses for trial. Because the EJS had conducted all pre-trial hearings at the Bondsteel detention facility, detainee transportation was not necessary as detainees were walked from the detention tents to the hearing tents that were within the detention facility. Witness transportation issues were also complicated by the appointment of a permanent judiciary. Multiple hearing locations required additional support from line units to secure witnesses for hearings. With no established mail system in Kosovo, soldiers were used to deliver subpoenas to witnesses and often to deliver witnesses to trial.

Detention operations were also altered by the start of criminal trials. Kosovars convicted of crimes became prisoners rather than pre-trial detainees. Although distinctions in the treatment of the two categories of individuals were subtle, changes in the handling of a prisoner did occur.⁷² Criminal conviction also required creating additional post-trial tracking mechanisms.

Prisons

The Task Force Falcon AOR did not contain a large detention facility like those found in Prizren, Istok, Lipljan, and Duprava. The lessons of Somalia and Haiti, however, foretold that U.S. KFOR would have to plan for short-term detention until detainees could be transferred to the host-nation system.⁷³ Under the proposed Rambouillet Accords, Task Force Falcon recognized that KFOR must be prepared to detain individuals who posed a threat to KFOR, but who should not be turned over to remaining MUP authorities. Task Force Falcon also recognized that the gap in establishing the communal police (when only the MUP remained) jeopardized the detention mission. Task Force Falcon pressed KFOR to take advantage of a centrally located and established Kosovo prison for use as a multinational KFOR detention facility. In a detailed

memorandum, the Commander, Task Force Falcon, recommended that COMKFOR “consider planning for and resourcing a multinational detention facility in the vicinity of Pristina for the first 60 to 90 days that KFOR is on the ground in Kosovo.”⁷⁴ Despite the Task Force Falcon recommendation, KFOR did not address detention issues until after the signing of the MTA.

After the signing of the MTA, planners in Task Force Falcon continued to believe that a centrally-run detention operation was in the best interest of the KFOR mission.⁷⁵ Task Force Falcon thus proposed and drafted a complete detention facility plan for a centralized detention facility for KFOR.⁷⁶ As with policing and pre-trial detention review, however, KFOR made detention facilities a decentralized issue, to be handled by the troop contributing nations.

The first detainee, arrested 4 days into the Task Force Falcon mission, was initially housed in a small military tent, surrounded by concertina wire. A Humvee’s headlights provided security lighting. The Task Force, required to care for the detainee at a level no less than that accorded a Prisoner of War, pieced together personal use articles, such as a razor, shaving cream, and a toothbrush, for the detainee.⁷⁷ The detainee was fed MREs and was dressed in a PT uniform, spray-painted with a mark on the back of his shirt to distinguish him from soldiers in PT uniforms.

From this spartan beginning, Task Force engineers constructed a detention facility based on existing military doctrine.⁷⁸ Operating on the belief that UNMIK would quickly take over detention operations, the initial detention facility was small, holding approximately 50 detainees. Upon the realization of the Task Force that UNMIK would not be able to assume the detention mission, a larger detention facility was constructed. When completed, this facility consisted of six, tier-three, GP medium tents, three GP small tents, a shower facility, visitation area, and court tent. A fence, concertina wire, and lights surrounded the entire compound. A diagram of the detention facility is in Figure 3.

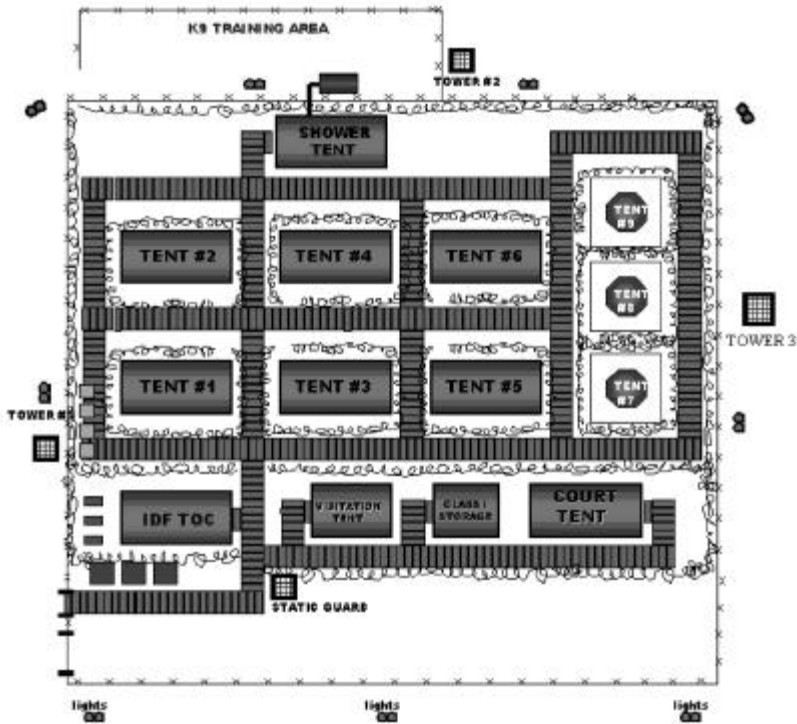

Figure 3. Diagram of the Camp Bondsteel Detention Facility

The ethnic background and sex of the detainees dictated tent assignments. Detainees slept on cots with sleeping bags. They were dressed in orange uniforms and athletic shoes. In the winter, the detainees were provided winter coats and boots. All support was provided through the Army's logistics system.

Detainees were allowed to smoke, write letters, and exercise, as well as receive visits from family members and attorneys. They were provided medical check-ups upon entry, and the detention facility was capable of dispensing medications. The condition of the detainees was reviewed by the International Committee of the Red Cross, the Organization of Security and Cooperation in Europe, the United Nation's Children's Fund, Amnesty International, and other human rights organizations. These organizations routinely gave the Task Force high marks for the care provided detainees.

A Military Police platoon operated the detention facility and detention facility operations were based on modified existing doctrine.⁷⁹ As detainees were brought into the facility, the MP prepared an entry in a detainee database that included the circumstances surrounding detention, basic background information, a photograph, and a listing of personal items confiscated from the detainee. MP and CID investigators, as well as counter-intelligence personnel, were able to interview the detainees upon their arrival at the detention facility. The detention facility at Camp Bondsteel processed a total of 1,800 detainees in the first year of operation. The largest population in the detention facility, at any one time during the first year, was approximately 110 detainees.

In March 2000, MP based in Gnjilane began work to improve the existing holding cells located adjacent to the Gnjilane courthouse in order to bring the condition of the cells to an acceptable standard. After completing improvements on the holding facility, it was turned over to UNMIK for operation. This facility allowed UNMIK to assume detention operations for less serious offenders as they awaited initial hearings before Investigating Magistrates. The Gnjilane holding facility provided some small relief to the detention operations at Camp Bondsteel. After 1 year, however, the Camp Bondsteel detention facility remained a major mission of the Task Force, and there was no clear plan by UNMIK to assume detention operations within the Task Force Falcon AOR.

Lessons

At the 1-year mark, it is impossible to evaluate the overall success of the law and order mission in Kosovo. The United States military's adaptability in confronting the law and order challenges provided a strong foundation for the overall UNMIK mission; however, the establishment of a fair and just public security system is not a short-term mission. Drawing on the observations of the first year, some remarkable accomplishments and apparent shortcomings are evident.

Generally, progress in one area of the security triad is ineffective without timely improvements in all areas. Additionally, improvements by the civil administration in one area do not necessarily result in diminished responsibilities for the military. To the contrary, the secondary and tertiary effects of civil progress can lead to increased military responsibilities in other areas of public security.

Police

The international community is incapable of rapidly recruiting and deploying international police. Moreover, the constabulary forces of the troop contributing nations may be insufficient to bridge the deployment gap. Line units must be prepared to discharge the policing function in the event that a law enforcement vacuum exists. U.S. peacekeeping doctrine dealing with law enforcement has not been sufficiently developed. A comprehensive review of doctrinal and training issues, such as basic law enforcement by line units, must be conducted in order to capture the successes of the policing aspect of the Kosovo mission.

Decentralizing the standards for law enforcement and detention may lead to differing levels of process provided to detainees by each troop-contributing nation, but this provides a framework for law enforcement that is easily understood and rapidly implemented by multinational participants.

Decentralized policing activities may lead to ineffective policing across Multinational Brigade boundaries as no centralized/unified criminal intelligence authority exists to provide review of criminal activity and poor lateral lines of communication between the independent Brigades prevents criminal intelligence sharing.

Courts

When operating under Chapter VII of the U.N. Charter, and faced with a law and order vacuum that includes a void in the judicial system, the United States must consider whether there exists legal authority for the conduct of emergency criminal trials. In the absence of such authority, the United States must encourage the United Nations to adopt *ad hoc* emergency procedures for criminal trials. When used upon initial entry, for a limited time, emergency procedures for criminal trials can enhance the legitimacy of the security force, prevent criminal wrongdoers from escaping justice, and afford the civil presence sufficient time to establish an appropriate, indigenous judicial system.

Prisons

Joint detention centers provide economies of scale that free up personnel assets that can be used for other security missions. If required to build

and operate a detention facility, the military using slightly modified, existing doctrine can accomplish this portion of the justice triad.

¹Judge Advocate General's Corps, United States Army. Presently assigned as Director, Training and Support, Center for Law and Military Operations, The Judge Advocate General's School, United States Army. B.A., 1990, Hampden-Sydney College; J.D., 1993, T.C. Williams School of Law at The University of Richmond. Formerly assigned as the Deputy Legal Advisor, Task Force Falcon, Kosovo, 1999-2000; Chief, International and Operational Law and Senior Trial Counsel, 1st Infantry Division, Wuerzburg, Germany 1998-99; Trial Counsel and Administrative Law Attorney, V Corps, Hanau Branch Office, Germany 1997-98; Trial Counsel, 19th Theater Army Area Command, Taegu, Korea 1994-96. Member of the Bar of the Commonwealth of Virginia. The author would like to thank the many individuals who commented on this article in its various stages of development—in particular, COL David Graham, LTC Mark Martins, LTC Sharon Riley, MAJ Mike Henry, MAJ Eric Jensen, MAJ Mike Lacey, CPT Brian Heslin, CPT Charlie Kovats, CPT Chris Jacobs, and CPT Tim Goloversic.

²The Center for Law and Military Operations is a resource organization for operational lawyers. It was created in 1988, at the direction of the Secretary of the Army, and is located at The Judge Advocate General's School of the Army in Charlottesville, Virginia. The Center's mission is to examine legal issues that arise during all phases of military operations and to devise training and resource strategies for addressing those issues. CLAMO can be reached at CLAMO@hqda.army.mil or (804) 973-6339.

³Ivo Daalder, senior fellow, Brookings Institute, quoted in James Kitfield, "Balkans Outlook," *National Journal*, December 23, 2000.

⁴U.S. forces have faced numerous peacekeeping deployments with difficult law and order missions. See e.g., Colonel F. M. Lorenz, "Land and Anarchy in Somalia," *Parameters*, Winter 1993-94, at 27; *Law and Military Operations in Haiti 1994-1995: Lessons Learned for the Judge Advocate* at 63 (The Center for Law and Military Operations 1995)[hereinafter *Haiti*]; *Law and Military Operations in The Balkans 1995-1998: Lessons Learned for the Judge Advocate at 109* (The Center for Law and Military Operations 1998)[hereinafter *Balkans*]. Task Force Falcon drew on all of these experiences when addressing the broad Kosovo law and order mission.

⁵*Policing the New World Disorder: Peace Operations and Public Security*, (Robert B. Oakley, Michael J. Dziedzic, and Eliot M. Goldberg eds.), available at <http://www.ndu.edu/inss/books/policing/cont.html>. Appendix C describes the case study framework adopted by the editors to study peacekeeping operations. Where possible, this article attempts to answer many of the same questions posed to the contributing authors of the seven case studies.

⁶See generally *Haiti*, supra note 2, at 102 (discussing the three-legged stool).

⁷*Kosovo/Kosova As Seen, As Told: An analysis of the human rights findings of the OSCE Kosovo Verification Mission October 1998 to June 1999* at Ch. 6 "Torture and Ill-Treatment" (Organization for Security and Cooperation in Europe 1999)[hereinafter *Kosovo/Kosova*], available at <http://www.osce.org/kosovo/reports/hr/part1/ch6.htm>.

⁸The Armed Forces of Yugoslavia (VJ) were present in considerable numbers in Kosovo. Although a conventional military force, the VJ and the MUP were mutually supportive forces that often conducted joint operations. The authority to arrest and detain citizens of Kosovo did not extend to VJ forces; it is clear, however, that the VJ were heavily involved in both arrest and detention in the late 1990's. *Reality Demands: Documenting Violations of International Humanitarian Law in Kosovo 1999* at 50 (International Crisis Group 2000)[hereinafter *Reality*] available at <http://www.crisisweb.org/projects/showreport.cfm?reportid=57>; see also *Kosovo/Kosova*, supra note 5, at Ch. 3 "The Military/Security Context." Also within Kosovo, prior to KFOR's arrival, were various armed men described as "paramilitaries." These groups included "Arkan's Tigers" and "Frenkis." *Reality* at 54. The widespread abuses described above were not limited to those of the MUP but also included abuses effected by both regular military and paramilitary personnel.

⁹*Kosovo/Kosova*, supra note 5, at Ch. 3.

¹⁰Id. at Ch. 9 "Arbitrary Arrest and Detention;" see also *Reality*, supra note 6, at 61 (identifying standard MUP and VJ *modus operandi*).

¹¹*Kosovo/Kosova*, supra note 5, at Ch. 3.

¹²See infra Section IIIB.

¹³"United Nations Interim Administration Mission in Kosovo: Report of the Secretary General," para. 66 (1999)[hereinafter *UNMIK Report*], available at <http://www.un.org/Docs/sc/reports/1999/s1999779.htm>; see also *Observations and Recommendation of the OSCE Legal System Monitoring Section: Report 2—The Development of the Kosovo Judicial System (10 June through 13 December 1999)* note 14 and accompanying text (OSCE 1999)[hereinafter *Report 2*], available at <http://www.osce.org/kosovo/publications/law/legal2.htm>.

¹⁴*Kosovo/Kosova*, supra note 5, at Ch. 10 "Violation of the Right to Fair Trial."

¹⁵XV Criminal Code of the Federal Republic of Yugoslavia (KZSRJ) art. 125 ("Whoever causes an explosion, fire or takes some other generally dangerous action out of hostile motives against the [FRY], or commits an act of violence which may create a feeling of personal insecurity in citizens or in a group of citizens, shall be punished by imprisonment for not less than five years."); XV KZSRJ 136 ("(1) Whoever sets up a cabal, band, group or any other association of persons for the purpose of committing criminal acts under [Article] 125..., or whoever forms a group for the purpose of transferring or dispatching citizens of the [FRY] abroad for the sake of carrying out hostile activities against the [FRY], shall be punished by imprisonment for not less than five years. (2) Whoever becomes a member of an association referred to in paragraph 1 of this article, shall be punished by imprisonment for not less than one year. (3) The member of an association referred to in paragraph 1 of this article who exposes the association before he has committed a criminal act defined in the provisions of this chapter in the association's ranks or on its account, shall be punished by imprisonment for a term not exceeding three years, but the court may also refrain from imposing a punishment on him."), translated and reprinted in *Kosovo/Kosova*, supra note 2, at Ch. 10.

¹⁶XV KZSRJ 137 ("(1) Whoever conceals, shelters or gives food, material, money and other means to the perpetrator of a criminal act referred to in [article] 136 ... of this law, whoever serves him in maintaining liaison, undertakes actions aimed at obstructing the discovery or apprehension of the offender, or renders him assistance in any other way, shall be punished by imprisonment for not less than 1 year. (2) The sentence for the acts referred to

in paragraph 1 of this article may not be more severe by neither its type nor its gravity [sic] than the sentence prescribed for the criminal act which was the subject of the assistance.”), translated and reprinted in *Kosovo/Kosova*, supra note 5, at Ch. 10.

¹⁷*Kosovo/Kosova*, supra note 5, at Ch. 10.

¹⁸*Detentions and Abuse in Kosovo* at 3 (Human Rights Watch 1998), available at <http://www.hrw.org/reports98/kosovo2/Kos9812.htm>.

¹⁹*Kosovo/Kosova*, supra note 5, at Ch. 10.

²⁰*Id.* at Ch. 6 (detailing reports of activities in prisons across Kosovo).

²¹Military Technical Agreement between the International Security Force (“KFOR”) and The Governments of the Federal Republic of Yugoslavia and the Republic of Serbia, 9 June 1999 [hereinafter MTA], available at www.nato.int/usa/policy/d990609a.htm.

²²S.C. Res. 1244, U.N. SCOR, U.N. Doc. S/RES/1244 (1999)[hereinafter UNSCR 1244], available at www.un.org/Docs/scres/1999/99sc1244.htm.

²³Undertaking of Demilitarization and Transformation by the UCK, 20 June 1999 [hereinafter Undertaking], available at <http://www.legacyrus.com/NewsReel/Kosovo/KLADisarmAgreement.htm>.

²⁴UNSCR 1244, supra note 20, at para. 9(d).

²⁵*UNMIK Report*, supra note 11, at para. 6.

²⁶*Id.* at para. 61.

²⁷*Id.* at para. 60.

²⁸Summary *Statement of the Right of KFOR to Apprehend and Detain*, Special Rep. U.N. Sec’y Gen. (6 July 1999), available at http://www.un.org/peace/kosovo/news/99/jul99_1a.htm.

²⁹UNSCR 1244, supra note 11, at para. 11(a).

³⁰*E.g.*, Rambouillet Accords: Interim Agreement for Peace and Self-Government in Kosovo, unsigned, Fed. Rep. Yugo.-Serb.-Kosovo, U.N. Doc. S/1999/648 (1999)[hereinafter Rambouillet] Ch. 7, Art. VIII, Sec. 1 (“KFOR will deploy and operate without hindrance and with the authority to take all necessary action to help ensure compliance with this Chapter); Ch. 7, Art. VII, Sec. 3c (“KFOR shall have the right to fulfill its supporting tasks...which include the following...to help create secure conditions for the conduct by others of other tasks...[and] to assist international agencies in fulfilling their responsibilities in Kosovo.”); Ch. 7, Art. VII, Sec. 6 (“COMKFOR shall have the authority, without interference or permission of any Party, to do all that he judges necessary and proper, including the use of military force, to protect KFOR and the IM, and to carry out the responsibilities listed in this Chapter.”), available at http://www.kosovo.mod.uk/rambouillet_text.htm.

³¹The phrase “contribute to a secure environment” may also have provided a basis for arrest and detention by KFOR.

³²Rambouillet, supra note 28, at Ch. 7, Art. 6, Sec. 1b(2) (Defining offensive assets as armored vehicles mounting weapons 12.7mm or larger and all heavy weapons of over 82mm).

³³The 1-year deadline could be extended an additional year at the approval of the CIM to meet operational needs. *Id.* at Sec. 1c(4).

³⁴*Id.* at Ch. 2, Art. VII, Sec. 1.

³⁵See generally *UNMIK at 12 Months: UNMIK Civilian Police Services* (UNMIK 2000)(Providing an overview of the UNMIK mission at the 1-year anniversary), available at <http://www.un.org/peace/kosovo/pages/>

twelvemonths/civpol.html. The build-up of International Police (UNMIK-P) can be traced by reviewing the archives of “UNMIK Latest Development ‘News Archive,’” available at <http://www.un.org/peace/kosovo/news/99/kosarc.htm>.

³⁶See generally *OSCE Mission in Kosovo: One Year On* (OSCE June 2000)(providing an overview of police education and development). The build-up of police in the Kosovo Police Service can be traced by reviewing the archives of “OSCE—Latest news releases,” available at http://www.osce.org/news_scripts/index.php3.

³⁷The numbers of MUP available under Rambouillet are taken directly from the Rambouillet Accords. The estimated number of KPS available is based on the rate of recruitment of KPS during the UNMIK mission; however, the estimate assumes that the recruitment could have occurred more rapidly (3 months) and that the numbers would have been slightly higher (25 percent), based on the above described circumstances. The estimated numbers of UNMIK-P available is based on the rate of deployment of UNMIK-P during the UNMIK mission; however, the number is lowered by 25 percent because it is assumed that the need for an international police presence would not have been as high under the circumstances of the Rambouillet Accords.

³⁸See *Background Report: The treatment of minorities by the judicial system* (OSCE 2000), available at <http://www.osce.org/kosovo/publications/law/rep5.pdf>.

³⁹*UNMIK Report*, supra note 11, at para. 68.

⁴⁰Seven Serbs were initially appointed to the EJS. One left Kosovo. The other six resigned, citing security concerns. The EJS did include four Bosniacks, one Roma, and one Turk. *Observations and Recommendations of the OSCE Legal System Monitoring Section: REPORT 1—Material Needs of the Emergency Judicial System* (OSCE 1999)[hereinafter *Report 1*], available at <http://www.osce.org/kosovo/publications/law/legal1.htm>.

⁴¹Within one Kosovo district (Prizren), actual criminal trials occurred under the EJS. *Report 2*, supra note 11.

⁴²For a more complete description of this problem see *Kosovo: Review of the Criminal Justice System* at 12, 15 (Legal Systems Monitoring Section, OSCE 2000)[hereinafter *LSMS Report*], available at <http://www.osce.org/kosovo/publications/law/crjustice.pdf>; *A Fragile Peace: Laying the Foundations for Justice in Kosovo* at Sec. IIA (Lawyers Committee for Human Rights 1999)[hereinafter *Fragile Peace*], available at <http://www.lchr.org/pubs/kosovofull1099.htm>.

⁴³*U.N. Mission in Kosovo, Reg. 1999/1, On the Authority of the Interim Administration in Kosovo*, (12 Aug 1999)[hereinafter *UNMIK Reg. 99/1*], available at <http://www.un.org/peace/kosovo/pages/regulations/reg1.html>.

⁴⁴*U.N. Mission in Kosovo, Reg. 1999/24, On the Law Applicable in Kosovo*, sec. 1(4) (12 Dec. 1999)[hereinafter *UNMIK Reg. 99/24*], available at <http://www.un.org/peace/kosovo/pages/regulations/reg24.html>; *U.N. Mission in Kosovo, Reg. 1999/25, Amending UNMIK Regulation No. 1999/1 on the Authority of the Interim Administration in Kosovo*, sec. 1 (12 Dec. 1999)[hereinafter *UNMIK Reg. 99/25*], available at <http://www.un.org/peace/kosovo/pages/regulations/reg25.html>.

⁴⁵*Task Force Falcon Detention Hearing Report*, 22 July 1999 (On file with the Center for Law and Military Operations). U.S. KFOR Detainee number 1 was accused of murder and attempted murder. He was detained by Marines of the

26th MEU on 18 June 1999. His criminal trial was concluded at the end of May 2000.

⁴⁶See *infra* Section IV.

⁴⁷The first case to be tried by the newly appointed courts was not U.S. detainee number 1, a Serb who had been in pre-trial detention since 18 June 1999. Rather, the first trial was of an Albanian detainee who was apprehended just four months prior to his trial.

⁴⁸*LSMS Report*, *supra* note 40, at 13.

⁴⁹See *Starting Over from Scratch in Kosovo: The Honeymoon is Over*, ICG Balkans Report No. 83 at 2 (International Crisis Group 1999)[hereinafter *Honeymoon*] (criticizing the delay in starting a judicial system), available at <http://www.intl-crisis-group.org/projects/showreport.cfm?reportid=22>; see also *Fragile Peace*, *supra* note 40, at Sec. III.

⁵⁰*UNMIK 1st Anniversary Background—Reviving Kosovo's Judicial Systems* (UNMIK 2000)(Providing an overview of the UNMIK's efforts to establish a judicial and penal system), available at <http://www.un.org/peace/kosovo/pages/twelvemonths/law.html>.

⁵¹Because the deployment of forces into Kosovo, a province of the sovereign Federal Republic of Yugoslavia, was technically permissive, the body of international law applicable in wartime did not apply. Under prevailing peacetime international law, a sovereign nation applies its own domestic law within its sovereign territory. See *Restatement (Third) of the Foreign Relations of the United States*, sec. 206, cmt. b (1986). Although the KFOR mandate was not that of an occupier, had it been, the law of occupation also required the penal laws and tribunals of Kosovo to remain in force. Geneva Convention Relative to the Protection of Civilians in Time of War, Aug. 12, 1949, art. 64, 6 U.S.T. 3518, 75 U.N.T.S. 290 reprinted in *Dep't of Army, Field Manual 27-10, The Law of Land Warfare*, at para. 369 (18 July 1956). UNMIK further enforced this standard with the promulgation of its first regulation. *UNMIK REG. 99/1*, *supra* note 41, at Sec. 3 (establishing the applicable law as that in force in the territory of Kosovo prior to 24 March 1999). But see, *supra* note 40 and accompanying text describing the difficulties in determining the applicable law in Kosovo; Memorandum from MAJ Michael J. Henry, Legal Advisor, Task Force Falcon, to Commander, Task Force Falcon, subject: Information on the Applicable Law in Kosovo (27 October 1999)(on file with The Center for Law and Military Operations).

⁵²See Summary of Phone Interview by Frederick M. Lorenz with LTC Richard Batty, UK Army, Senior Legal Advisor, Allied Rapid Reaction Corps (ARRC), available at http://www.ilacinternational.org/Corporate_Structure/Structure.htm (“In Kosovo we let each Brigade develop its own arrest rules....This was because we had no time to train people and develop a new standard, and each of the national Brigades was compliant with basic human rights standards and/or the European Convention on Human Rights.”). Beginning in July 1999, LTC Batty was the legal advisor to COMKFOR. While the law of the FRY was applicable, there was the practical problem that no one in KFOR had an English-language version of the FRY Code.

⁵³See e.g., 1st Infantry Division, Leaders Legal Briefing, Slide 40 (1999)(explaining, *inter alia*, the right of soldiers to detain civilians who “commit criminal misconduct”)(on file with The Center for Law and Military Operations). The Leaders Legal Briefing was designed to give officers and senior NCOs deploying to Kosovo an overview of the legal framework allowing

U.S. entry and operation as the security presence in Kosovo. It included a discussion of some mission specific ROE provisions.

⁵⁴Command Policy Memorandum, Headquarters, Task Force Falcon, subject: Policy Letter #TFF-04 Detention Processing, para. 2c(3)(weapons violations), 2c(4)(UCK uniform violation), 2c(7)(establishing an unauthorized checkpoint), 2d(1)(curfew violations)(3 August 1999)[hereinafter *Detention Policy*]; see also Undertaking, supra note 21, at paras. 22-23 (detailing the demilitarization of the UCK); MTA, supra note 19, at art. II (explaining the cessation of the hostilities and phased withdrawal of FRY forces), App. B, para. 5 (authorizing KFOR to compel removal, withdrawal, or relocation of weapons).

⁵⁵*Detention Policy*, supra note 52, at para. 2a(1); see also *U.N. Mission in Kosovo, Reg. 1999/2, On the Prevention of Access by Individuals and Their Removal to Secure Public Peace and Order*, sec. 2 (12 Aug 1999)[hereinafter *UNMIK Reg. 99/2*](explaining right to detain civilians posing a threat to public peace and order), available at <http://www.un.org/peace/kosovo/pages/regulations/reg2.html>; MTA, supra note 19, at App. B, para. 5 (allowing use of force to prevent acts that are considered a threat to KFOR or the KFOR mission).

⁵⁶*Detention Policy*, supra note 52, at para. 5b instructed soldiers responding to a host of crimes to establish control of the scene, notify the MP, take statements from the victims and witnesses (sworn statements when possible), prepare a sketch of the scene, render personal statements, account for all physical evidence on a DA Form 4137, and bring the suspect(s) and all documents to the nearest MP substation.

⁵⁷See Email from LTC Mark Martins, the first Legal Advisor, Task Force Falcon, to CPT Alton L. Gwaltney, Director, Training and Support, Center for Law and Military Operations (10 January 2001, 6:09 PM EST)(on file with The Center for Law and Military Operations). The team of lawyers initially assigned to Task Force Falcon brought a host of experiences and training to the deployment. One had previously taught Comparative Legal Systems for The Judge Advocate General's School, Army, where he came into contact with numerous civil law systems, including FRYs; he also authored *Haiti*, supra note 2. All of the attorneys had criminal law training, and many had served as criminal prosecutors or defense attorneys prior to deploying.

⁵⁸See *Manual for Courts-Martial, United States*, R.C.M. 305(h)(2)(A)(1998); cf. *Riverside County v. McGlaughlin*, 500 U.S. 44 (1991)(imposing a review within 48 hours of pretrial confinement); compare XV KZSRJ 192, 197 (requiring a review within 24 hours of pretrial confinement).

⁵⁹*MNB-E Detention Process SOP, Office of the Staff Judge Advocate, Task Force Falcon*, at 3 (undated)(on file with The Center for Law and Military Operations). These standards were similar to those used in detention hearings in Haiti. See *Haiti*, supra note 2, at 68-69. The standards also had a basis in the Criminal Code of the Federal Republic of Yugoslavia. See XV KZSRJ 191(2) (allows for continued pre-trial detention if the following circumstances surround the grounds for custody: 1. If [the detainee] conceals himself or if his identity cannot be established or if other circumstances obtain which suggest the strong possibility of flight; 2. If there is a warranted fear that [the detainee] will destroy the clues to the crime or if particular circumstances indicate that he will hinder the inquiry by influencing witnesses, fellow defendants or accessories after the fact; 3. If particular circumstances justify a fear that the crime will be repeated or an attempted crime will be completed or a threatened crime will be committed; 4. If the crime is one for which a prison sentence of

10 years or more severe penalty may be pronounced under the law and if, because of the manner of execution, consequences or other circumstances of the crime, there has been or might be such disturbance of the citizenry that the ordering of custody is [urgently] necessary on behalf of the unhindered conduct of criminal proceedings or human safety.

⁶⁰The basic criminal charges were broken into 4 categories. Category I crimes were hostile acts or threats toward KFOR and War Crimes. Category II crimes were murder, rape, kidnapping, arson, aggravated assault, any crime involving a suspect that had been previously detained by KFOR, and any crime in which a weapon was used in the commission of the crime. Category III crimes were burglary/housebreaking, larceny/looting, weapons violations, UCK uniform violations, driving under the influence of alcohol or drugs, prostitution, establishing an unauthorized checkpoint, destruction of property, black-marketing, simple assault, harassment, use or possession of illegal drugs, possession of stolen property, auto theft/carjacking. Category IV crimes were curfew violations and drunk and disorderly conduct. *Detention Policy*, supra note 52, at para. 2.

⁶¹On-scene Commanders had the authority to order the release of Category IV detainees in order that they not be transported to Camp Bondsteel. The Provost Marshal had the authority to release Category III or IV detainees, prior to the case being sent to the Military Magistrate. *Detention Policy*, supra note 52, at para. 3.

⁶²See supra note 57 for the standards for continued pre-trial detention under the Criminal Code of the Federal Republic of Yugoslavia.

⁶³XV KZSRJ 197.

⁶⁴*U.N. Mission in Kosovo, Reg. 1999/5, On the Establishment of an ad hoc Court of Final Appeal and an ad hoc Office of the Public Prosecutor* (4 Sep 1999)[hereinafter *UNMIK Reg. 99/5*], available at <http://www.un.org/peace/kosovo/pages/regulations/reg5.html>.

⁶⁵*U.N. Mission in Kosovo, Reg. 1999/26, On the Extension of Periods of Pre-trial Detention* (22 Dec 1999)[hereinafter *UNMIK Reg. 99/26*], available at <http://www.un.org/peace/kosovo/pages/regulations/reg26.html>.

⁶⁶Assuming that the criminal charges were not actually dismissed, detainees released from pre-trial detention continued to face criminal charges and trial in much the same way as someone arrested in the U.S. system and released on bail continues to face criminal charges. Because of the extreme backlog of criminal cases faced by the judiciary, an overall lack of court officials and rudimentary systems (phone/mail), everyone understood that the only detainees who would be brought to trial were those who remained in detention until trial.

⁶⁷Memorandum, LTC Richard Batty, UK Army, KFOR Legal Advisor to LTG Michael Jackson, Commander, Kosovo Forces, Subject: COMKFOR Authority to Overrule Judicial Release Order (30 July 1999)(on file with the Center for Law and Military Operations).

⁶⁸But see *LSMS Report*, supra note 40, at 27 (explaining that the “72 hour rule” is not grounded in FRY Criminal Procedure and calling for a change in this procedure).

⁶⁹See infra note 46 and accompanying text.

⁷⁰See *LSMS Report*, supra note 40, at 61 (detailing specific cases that raised concern with the OSCE regarding the ethnic bias of the courts).

⁷¹Gnjilane was a district court. District courts had the authority to hear criminal cases and adjudge more than 5 years confinement upon conviction. The other

courts were Municipal Courts. Municipal Courts could adjudge up to 5 years confinement upon a criminal conviction. Initially, only the Gnjilane courthouse was available for trials. The court building in Vitina was being used as a Company Command Post, and the courthouse in Urosevac was a Battalion Headquarters. Initially, the Urosevac courts continued the pre-trial detention hearings at Camp Bondsteel. Trials for the Urosevac municipal court were conducted in Pristina, the higher district court for Urosevac. Both the Company CP and the Battalion HQ eventually moved to new locations so that the courts could be improved and used for trials. Trials for Vitina and Kaminica were conducted in Gnjilane until the physical court facilities could be brought to an acceptable physical and safety standard.

⁷²See e.g., *Manual for Courts-Martial, United States, R.C.M. 304(f)*(1998)(pre-trial prisoners not punished; cannot wear uniform of post-trial prisoner).

⁷³See supra note 2.

⁷⁴Memorandum from Brigadier General Bantz Craddock, Commander, Task Force Falcon, to LTG Michael Jackson, UK, Commander, Allied Rapid Reaction Corps, (25 March 1999), summarized in e-mail, LTC Mark Martins, first Legal Advisor, Task Force Falcon, to CPT Alton L. Gwaltney, Director, Training and Support, Center for Law and Military Operations (11 Jan 2001 12:30 PM EST)(on file with The Center for Law and Military Operations).

⁷⁵See e-mail, Legal Advisor, Task Force Falcon to Staff Judge Advocate, U.S. European Command, subject: Update, para. 3 (12 July 1999 3:22 PM CET)(“Compared notes today with Lt Col Redden, 5th UK (Abn) Bde Legal Advisor and his PM on detention and related issues. He is keen, as are we, to turn the jailing and detention process over to UNMIK. We have to try to use one of the hardened jails in the Pristina area and set up the provisional judges nearby in an office.”)(on file with The Center for Law and Military Operations).

⁷⁶Detention Facility Plan drafted by Task Force Falcon for KFOR (13 June 1999)(on file with The Center for Law and Military Operations).

⁷⁷See generally Geneva Convention Relative to the Treatment of Prisoners of War, Aug. 12, 1949, 6 U.S.T. 3316, 75 U.N.T.S. 135; North Atlantic Treaty Organization Standardization Agreement 2044, Standard Procedures for Dealing with Prisoners of War (6 Mar. 1957), reprinted in *U.S. Department of Army Field Manual 19-40, Enemy Prisoners of War, Civilian Internees, and Detained Persons*, App. B (27 Feb. 1976)[hereinafter *FM 19-40*].

⁷⁸*FM 19-40*, supra note 74; *U.S. Department of Army Field Manual 19-4, Military Police Battlefield Circulation Control, Area Security and Enemy Prisoners of War Operations* (7 May 1993).

⁷⁹Lieutenant Colonel Richard W. Swengros, “Military Police Functions in Kosovo,” *Military Police Bulletin*, May 2000 at 8.

CHAPTER XIII

The Operational Art of Civil-Military Operations: Promoting Unity of Effort

Christopher Holshek

If “in war, even the simplest things become difficult,” as Clausewitz observed, then in peace they are just about impossible. Nowhere has this been more true than in the complex international emergency humanitarian relief, peacekeeping, and peace building missions of the past few years, particularly in Kosovo. The efforts there to end violence and suffering and establish law and order, public administration, public services, and economic self-sustainability have been the most elaborate international endeavor of its kind since the late 1940s. Especially in the early phases, the crossroads of these activities in-country lie horizontally between the civilian organizations, which now lead the full spectrum of humanitarian relief to reconstruction activities in post-conflict environments, and the military forces deployed to secure and stabilize the area and help enable these efforts. Vertically, the critical level is where resources can be most effectively mobilized, so that the whole international community, paradoxically, can leave soonest. If civilians, not soldiers, are now the nation-builders, then a salient lesson is coming into focus as a result of missions like Kosovo. The major challenge to present and future peace operations will be to improve the ability of the many players in the field to work together more effectively. Consider this single fact: According to a NATO Kosovo Force (KFOR) database, in September 2000, there were over 650 separate international, nongovernmental, and private voluntary organizations (NGOs/PVOs)¹ in Kosovo—an area the size of the U.S. state of Connecticut or Yorkshire county in England. It is not that the international presence in Kosovo has been too small. It has been largely uncoordinated. By promoting unity of effort, operational civil-military operations (CMO) can be the fulcrum to leveraging the success of these missions.

This treatise, therefore, focuses on the operational level of CMO in the NATO Kosovo Force (KFOR), not because there has not been valuable work done at the multinational brigades (MNBs) conducting tactical-level CMO², but simply to limit discussion to this emerging aspect of military peace support operations (PSO).

Strategically driven CMO has rapidly changed emphasis from the military's conduct of nation building (or what the U.N. calls peace building). Over the past 10 years of peace operations, the military has by and large gotten out of the business of conducting nation building as international organization and NGO/PVO capabilities improve. Tactical-level CMO has likewise shifted to the support of civilian-led peace building at local levels, as well as expanding its more traditional activities to promote the legitimacy of mainly the military's presence and operations among locals while minimizing friction between the military and the multiplying civilian players in the field. As civilian-led peace operations have become more complex, the critical juncture has likewise become the level at which the coordination of the overall effort takes place at the theater, joint task force (military), or U.N. mission headquarters level.

Operational-level CMO is critical to present and future peace operations, not just because it lies between the strategic and tactical centers of gravity of a PSO (and impacts both). More so, it is the level where the challenges to the success of an international peace operation are the greatest. These are not only in the coordination and synchronization of the myriad activities of the expanding number of donor-funded international organizations and NGOs/PVOs. More importantly, it is in the flow and management of information. This information is not just valuable to inter-entity coordination, to efficiently and effectively mobilize and distribute resources (to include funding), but also to win in a battlefield no longer measured by traditional indicators of operational success. It is measured by hearts and minds—not just local attitudes and the perceived legitimacy of the international presence and aims at the tactical level and the support for the international effort of the public constituents of the contributing nations at the strategic level, but the ability and confidence of the in-country international civilian and military presence to convince the resident political leadership to come to terms at the operational level.

There are key differences in the *modus operandi* of military versus civilian organizations. While the military normally focuses on reaching

clearly defined objectives through linear operational (planning and execution) progressions with given timelines under a unified command and control structure, civilian organization are concerned with a process of fulfilling changeable political interests through a fluctuating sequence of dialogue, bargaining, risk-taking, and consensus-building. As the U.N.'s first Principal Deputy Special Representative of the Secretary General (P/DSRSG) in Kosovo, Jock Covey, pointed out, the aim of this kind of process is to get the previously warring factions to "re-evaluate their interests," bit by bit, until they meet the conditions for peaceful coexistence and self-sustaining market democratic structures. Exactly how and when they get there should be left mainly up to the locals, in order to give the process legitimacy by sharing responsibility and avoiding the backlash inevitable to colonial-type rule.

Before September 11, 2001, the Bush Administration's near about-face on nation building, and the massive international intervention in Afghanistan, it was already clear that:

Whether they like it or not, the U.S. and European militaries have an important role to play and will be requested to participate in future peace support operations. The military is much better than civilian agencies at coordination and logistics, as well as their traditional tasks of enforcement and security. Significantly, there is a clear chain of command in the military, which is conspicuously lacking in many international organizations, and these are fundamental components for the smooth running of an operation. Additionally, in early stages, when the situation on the ground is too dangerous for most civilian agencies, the military can prepare the groundwork for political reconstruction, such as enforcing a curfew, demobilizing militias, demining, or providing security for elections, and in some cases, even running them.³

Inasmuch as civilian organizations need to better understand and accommodate the ways of military forces supporting them, the military must likewise be prepared to work with international civilians who operate from the converse of the Clausewitzian continuum, this time between politics and peace. It means a well-informed senior command

and staff must now work routinely in a multinational as well as a joint command-and-control environment, more complex and with many non-military players influencing the situation. It also means insuring the types of forces deployed are best suited for these operations (i.e., relatively more combat support and service support versus combat troops), especially as operational focus evolves. Central to this is making sure there are enough of the types of soldiers deployed at the right places and levels, and who can work both sides of the civil-military cultural divide and broker unity of effort.

This chapter first describes the operational CMO environment in Kosovo and provides observations on KFOR CMO, then offers some recommendations on how to improve future operational CMO capability to support unity of effort in peace operations. Summaries of both main points and major recommendations are at the end of the chapter.

The United Nations Interim Administration Mission in Kosovo—UNMIK

UNMIK's political, operational, and resource challenges owe a great deal to the complex political circumstances generated by the international community, which have in turn affected the nature of the overall operation, notwithstanding the peculiarities of civilian organizations explained above. Among key factors:

There is no clear end-state for Kosovo civil administration—i.e., nation building with no clear consensus at many levels on the national entity. Beyond encumbering serious planning, this forced the mission to work around (and often beyond) the legal and administrative boundaries of U.N. Security Council Resolution 1244 in all aspects of civil administration, under the rubric of substantial autonomy.

Although relief funding may have been adequate, transitional administration start-up funding was not—beyond the planning, deployment, and establishment phases of the mission. In addition to exacerbating more typical planning shortfalls, this has contributed to staffing shortages as high as 50 percent, hampered start-up logistics and service support operations, and delayed key relief-related infrastructure repair and public service restoration projects. This encumbers the credibility of the international community in the eyes of the Kosovars—the tactical-operational center of gravity. In addition,

however, this cycle hampers the perception of progress among the constituent publics of the major contributing nations—a strategic center of gravity.

No clear, comprehensive, and tested operational reference for planning, coordination, and execution of civilian-lead interagency civil administration was developed. Due in part to the unprecedented effort in Kosovo, there are really no commonly agreed indicators of success. There has been a great deal of criticism leveled at the U.N. mission for not getting things done fast enough, but in relation to what historical example? (The key lesson here is that it might be worthwhile for the major civil-military players to find at least some consensus on what constitutes success, not in terms of timelines but in terms of accomplishments that trigger political and operational advancement.)

UNMIK staff problems, to include: high staff vacancy rates; a high rate of turnover both to/from and within the mission (as much as 30-40 percent every 6 months); and a dearth of field-experienced junior, middle, and upper management and coordinating staff with sound project management and coordination, problem-solving, logistical, and team leadership skills.

Most significant is the diffuse, uncoordinated international presence caused by the original four-pillar structure under a nominally single executive authority (see below illustration). This is further complicated by the aforementioned plethora of independent and semi-independent governmental organizations and NGOs/PVOs, each with an agenda driven by donor politics. This has led at times to the allocation of resources and efforts to certain relief projects with high visibility while other, less attractive, and longer-term reconstruction needs were left wanting.

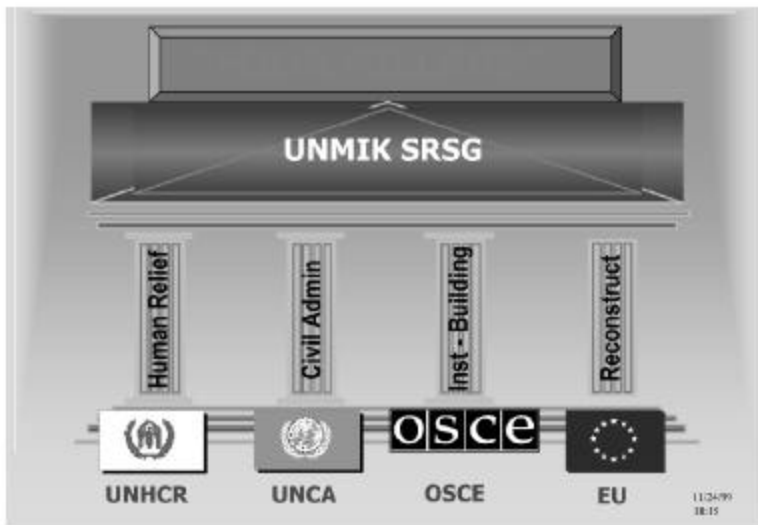

Figure 1. The Four Pillars of UNMIK

For example, in the early phases, the Department of Labor and Employment was frustrated not just in standardizing vocational training and technical accreditation, but in convincing donor organizations to support blue-collar vocational training (e.g., construction, auto repair and maintenance, etc.). Instead, there was an abundance of high-tech automation training in an essentially pre-industrial economy. Among the chief complaints of the then-UNMIK project manager was the lack of a central steering or coordinating structure to better manage these resources, as well as market-oriented labor laws.

According to a 2000 U.S. Institute for Peace report:

Given NGOs' independent agendas, varied resources, and different operating systems and capacities, depending on conditions and financing, NGOs could adopt common platforms and networks that preserve organizational integrity. Besides expediting relief implementation, such a system would help NGOs and donors move money away from duplication or efforts to reinvent the wheel and toward disbursal of more goods and services. What is needed is interoperable technology, headquarters to field

*and among field organizations and agencies; an interoperational network; archiving methodology; and capacities. This set of tools would address the different capacities, resources, and limitations of the organizations represented in the field.*⁴

Cooperation, coordination and interoperability within UNMIK, particularly in the first year, were not priorities. Even 2 years into the mission, it remained extraordinarily cumbersome to place a telephone call between the main offices of U.N. Civil Administration, or Pillar II, and the Organization on Security and Cooperation in Europe (OSCE), or Pillar III, about 300 yards away. Internal turf wars, documented as early as December 1999, abounded.⁵ As explained by a July 10, 2000 KFOR CIMIC liaison officer assessment of municipal registration and elections preparation, “the marriage between the two agencies made an already difficult task even more so.” While Pillar III managed the process then, Pillar II controlled much of the budgeting. Thus, although registration and elections were a success in 2000, they were “qualified by poor cooperation between Pillars II and III, and by a highly effective Serb boycott.” Tensions likewise existed between Pillars II and IV over such issues as public concessions to local enterprises for commercialization, municipal vs. central Joint Interim Administrative Structure (JIAS) allocation of assets and taxing authority, cost-recovery and assessment, and billing of public utility fees, especially for minority communities. Inter-pillar coordination and cooperation for the Kosovo-wide election in November 2001 was better, but largely because the election was mostly under the aegis of the OSCE.

All this friction in the early going caused overly long and/or uncoordinated decisionmaking cycles and a lack of operationally enabling information sharing and transparency among and within civilian departments. This, in turn, manifested in visibly ineffective public services and infrastructure restoration, undermining the credibility of civil administration in the eyes of the locals and thus encumbering KFOR’s intended end state.

Add to this the maximizing approach UNMIK or some of its officials applied to implementing the international mandate under U.N. Security Council Resolution 1244. In fairness, much of this owed to the political imperatives and lack of end-state forced on the mission by the Security Council and the international community. In many circumstances, such

as the physical and economic infrastructure, there was little choice other than to deal with basic problems that originated well before the war and its causes. The overhaul of the dilapidated power generation and distribution system and the revamping of telecommunications are good examples. In addition, it should not be forgotten that a legitimate attempt was made to transition from essentially Communist-era political and economic structures. As in most of the Balkans, there is practically no history or tradition of democratic or market economy experiences to draw upon.

In a number of cases, however, UNMIK staff liberally interpreted their mandate, the rationale being that certain fundamental socio-political-economic issues were best addressed upfront. An example of this kind of social engineering was a controversial rule that 30 percent of the candidates in the municipal and general elections must be female. The thinking was that women represent the largest constituency likely to be most supportive of peaceful interethnic coexistence, though in a steeply traditional, Muslim-oriented, patriarchic Kosovar Albanian society. Another was consideration of inducing EU-standard recycling programs before an effective trash collection and disposal system was in place. In many of their encounters with UNMIK civil administrators early on, KFOR CIMIC officers obtained the strong impression that many UNMIK staff, consciously or not, imposed post-industrial democratic, egalitarian, and free-market norms upon a pre-industrial, tribal culture with a tradition of cheating systems imposed by outsiders through parallel structures. They did not marshal resources first on basic economic necessities and effective public services. Prematurely induced democratic and free market structures without a sound system to provide reliable electricity, safe drinking water, policeman, judges, and lawyers you can trust risks not just a loss of legitimacy of both the international presence and these structures, but disillusionment with democracy and free enterprise in general. UNMIK eventually succeeded to a large extent, albeit more slowly and less smoothly than it could have.

When the new SRSG, Hans Haekkerup, took over from Bernard Kouchner in January 2001, he introduced a ministerial line-management system more suited to the reconstruction-intensive phase the mission was entering, as well as outlined priorities for the fulfillment of the mission's mandate. Streamlining of the bloated JIAS began, along with a process of gradual transfer of public administration decisionmaking authority to local control through joint interim structures as capacity grew. Under the Constitutional Framework hammered out in the spring

of 2001, preparations were made for the Kosovo general election and the final phase of transitional administration at the ministerial level. Recognizing the basic necessity of insuring security and law and order, a new Police and Justice Pillar was synthesized among mainly justice and police components of Pillars II and III. This was also due in part to recognition of the need for improved coordination and cooperation, both within the pillars of the mission and particularly between the U.N. and OSCE components of the mission. However, there was little consensus on how or how much it should be improved.⁶

UNMIK's mechanisms to provide oversight and coordinate activities both within and among the pillars of UNMIK were weak at first, but gradually improved. In addition to more empowered political and economic strategic planning under the Office of the SRSG, interdepartmental working groups and task forces began to proliferate in the summer of 2000, such as the P/DSRSG's Joint Planning Group and the Utilities Task Force. This was due to a maturing process among the staff and their recognition of the need for coordinating mechanisms to deal with increasingly interdisciplinary issues. Intra-UNMIK coordination improved, albeit largely *ad hoc*. It is worth noting that the *Report of the Panel on United Nations Peace Operations*, better known as the Brahimi Report, calls for improved interagency coordination and integrated mission planning at the strategic level (i.e., at UNHQ), the use of information technology as a key enabler to meet mission objectives, and the establishment of a responsibility centers and a electronic data clearing house with pervasive use of geographic information system (GIS) databases.⁷ Unfortunately, however, it offers no more concrete proposals for improving operational-level unity of effort.

Some noteworthy coordinating schemes were tried in the early phases. U.N. and donor agencies established an informal Geographic Information Support Team to test the feasibility of utilizing geographic information systems in a collaborative manner in Kosovo. The International Rescue Committee established a shared telecommunications infrastructure, Internet Project Kosovo (IPKO), for use by NGOs, international organizations, and the military with the intention of eventual turnover to local civilians. Also, NGOs created their own council to share information and organize projects. The ReliefWeb and others became valuable Web site sources of summary information and overall analysis, and a Rapid Village Assessment Form was developed to retrieve and share statistical information on vulnerable populations.

All were important steps to improve coordination in the field. However, they either never maintained momentum or were not comprehensive or powerful enough to pull all the information pieces together and synergize activity across-the-board. The most promising coordinating mechanism was the Humanitarian Community Information Center (HCIC), which the U.N. Office of Coordination of Humanitarian Affairs established in Pristina in coordination with UNHCR. The HCIC contributed enormously to information-sharing and database standardization. It pooled GIS data obtained from multiple sources, both civilian and military, and organized them along the lines of the JIAS departments in a conscious (and partially successful) attempt to institutionalize information transparency among the emerging public administrations structures.

UNMIK Strategic Planning, with the HCIC and KFOR CIMIC, led an initiative in 2000 to formalize information sharing. The premise was that if compatible data sets could be readily shared among major civilian and military players in Kosovo, unity of effort would improve as information have-nots (especially NGOs and local institutions) gravitated into the fold. Along with HCIC's Web site-like CD-ROM *Kosovo Encyclopedia*, there was consensus in late 2000 on formats for database inputs, among scores of often redundant and incompatible databases of village demographic, economic, and housing data. The initiative, unfortunately, lost momentum when UNMIK Strategic Planning disbanded in February 2001, although KFOR CIMIC consolidated a village database in early 2001.

Another success story was the close cooperation with KFOR CIMIC, to some extent in information sharing via the daily CIMIC reports and the KFOR CIMIC liaison office at UNMIK, but mostly due to the engagement of CIMIC liaison officers with UNMIK counterparts. This was the real strength of KFOR CMO. Despite occasional setbacks, civil-military interoperability was the most encouraging (and least understood) story on unity of effort in Kosovo. It has been best with the U.N. and its agencies, which can draw on nearly 50 years of institutional experience of joint (i.e., civil-military) peacekeeping not enjoyed by the OSCE and EU, which are relative newcomers. From the daily meetings between the SRSB and COMKFOR and the inclusion of the COMKFOR in the Kosovo Transitional Council (KTC) and Interim Administrative Council (IAC) at the executive level, there were many joint (although uncoordinated) meetings and working groups. In addition to the KFOR CIMIC liaison

office and the biweekly CIMIC meetings, there were: the Joint Security Executive Committee; the Joint Elections Operation Center (JEOC) at OSCE; the KFOR Press and Information Center, collocated with the UNMIK Media Center; the Joint Information Operations Working Group; and the Mine Action Coordination Center (MACC). There was also a loose association between the KFOR Joint Operations Center (JOC) and the UNMIK Situation Center, which maintained a standing operating procedure (SOP) for joint coordination in crisis situations (which was hardly ever exercised).

Despite its handicaps and challenges, UNMIK did better than advertised. In addition to two successful elections won largely by moderates, law and order and nascent economic life are germinating in Kosovo. Col. Michael Dziedzic (USAF), the NDU's Senior Military Fellow for Peace Operations at the Institute for National Strategic Studies, who was the UNMIK Director of Strategic Planning, observed that "piece by piece, the institutional underpinnings have been put in place to guide the political evolution toward a stable future, both internally and intra-regionally."⁸

Even after 18 months, 800,000 (mostly Kosovar Albanian) refugees and displaced persons had returned. Over 100,000 houses were repaired or rebuilt. There were 20 functioning co-headed administrative JIAS departments employing over 50,000 civil servants and 27 democratically elected and 3 appointed municipal assemblies—all beginning the process of transitioning managerial power to local authority. UNMIK Police finally reached its authorized strength of 4,500 international officers by the end of 2000. Meanwhile, the Kosovo Police Service, numbering more than 3,000 of which 16 percent came from minority communities, developed its professionalism. The Kosovo judiciary, with 400 Kosovo judges and prosecutors, and hundreds more lay judges supported by international judges and prosecutors, became increasingly effective.

This list goes on.⁹ However, by its own admission, UNMIK's greatest failings were in ensuring the security and freedom of movement of Kosovo's dwindling minority communities and putting an end to politically motivated violence. Still, hardly anyone in Kosovo died of cold or starvation over the first critical winter of 1999-2000. Demilitarization went relatively smoothly as neither the Kosovar Serbians nor the Kosovar Albanians chose to create a hostile environment for KFOR and UNMIK. This enabled KFOR to free up

resources to do other things than separate warring factions in those critical early months, which was ultimately of benefit to both UNMIK and KFOR. Likewise, UNMIK escaped what might have been political and operational disaster. In the first few months, had the refugee situation not been resolved, had the level of violence escalated out of control, and had the Kosovo leadership been much more demanding and critical of the international presence and less cooperative with UNMIK (to some extent, because of the presence of KFOR), the eventual success of the mission would have been nearly impossible. This relatively good fortune obscured the many inherent weaknesses of UNMIK, and even KFOR gave an impression of success that, to some extent, was by design. However, as said in the world of sports, “sometimes it’s better to be lucky than to be good.”

As mentioned before, military organizations enjoy certain comparative advantages over civilian agencies, namely in: executive decisionmaking; staff coordination; planning and organization; crisis management and other forms of problem solving; logistics; and training. KFOR often became the first option of response because of KFOR’s inherent comparative advantage in accomplishing tasks, KFOR’s position as the most trusted international entity among Kosovars (according to a series of Gallup polls), and the tendency of international bureaucrats to seek the path of political expediency in complex problem-solving. This threatened to grow into a culture of dependency, as in Bosnia, especially considering the paradox that in order to enable civilian self-reliance, KFOR has had to place itself in a position to jump-start UNMIK. This is a highly delicate situation for the military, even with the most trained and experienced CIMIC officers, and is even more difficult for non-CIMIC or inexperienced military leaders to grasp. In order to compensate for the shortfalls of civilian organizations, strike the fine balance between helping out and being the help, and work towards the end-state, the CMO role in operational level civil-military unity of effort was even more critical to international success in Kosovo.

The NATO Kosovo Force

Complicating civilian challenges to unity of effort in Kosovo has been the presence of a military force not under the executive authority of the SRSG, and burdened by a confederate command and control structure. When understanding KFOR CMO, it is important to understand the

realities of KFOR's mission and organization. KFOR has had essentially two missions. Foremost, as specified in UNSCR 1244, was "to establish a safe environment for all people in Kosovo and to facilitate the safe return to their homes of all displaced persons and refugees" (as well as to protect Kosovo from Milosevic and conduct demilitarization and stability operations in the province). Annex W of NATO OPLAN 31402 identifies KFOR's main effort to "establish and maintain a safe and secure environment for the people of Kosovo, UNMIK, NGOs, and international organizations, thus allowing them maximum opportunity to establish civil control and support within Kosovo." The second mission is in the KFOR CIMIC mission statement: "*within means and capabilities* [italics added], support the SRSB and international organizations and NGOs in Kosovo in their humanitarian, public security, civil administration and infrastructure repair tasks... *with a view to achieving the earliest possible transfer of non-military tasks to appropriate civil organisations* [italics added]".

In other words, KFOR was to coordinate with and support UNMIK. The May 10, 2000 COMKFOR General Directive 1 recognized that "the success of KFOR is inextricably linked to the success of UNMIK," and saw the need "to eliminate KFOR's requirement to support critical civil functions and/or tasks." The CMO mission has in many ways been at center stage at KFOR because: the refugee crisis resolved itself quickly; demilitarization went relatively smoothly; the less than violent change of leadership in Belgrade; civil administration has met enough success to contribute to a slowly emerging virtual cycle of stabilization; and security issues entail complex civil-military responses.

CMO, in turn, has been too encompassing and complex for the KFOR J9 to orchestrate, partly because CMO has pervaded the activities and elicited the subject matter expertise of other staff directorates such as the Legal Advisor, Engineers, et al., vis-à-vis critical civil-military aspects of peace support operations. It was also partly because it has been an opportunity for non-CIMIC directorates to find gainful employment during an operation other than war—though it would have been counterproductive not to include them. Particularly in the relief-intensive phases of Operation Joint Guardian, it would thus have been unrealistic for J9 to supervise all KFOR CMO, despite the current draft of NATO CIMIC doctrine calling for CIMIC to "oversee the conduct of civil-related activities by military forces, including the provision of requisite functional specialists."¹⁰ Besides, with only 20 to 25 personnel,

many of whom had little or no CMO training or experience, J9 has been stretched too thinly to cover such a huge breadth and depth of operational responsibility. Nonetheless, although J9 has lacked the rank structure and means to exercise the necessary span of operational CMO command and control, it has fortunately remained an operations rather than a support function in the HQ KFOR staff (see the below HQ KFOR staff chart).

In any case, in addition to a strategic vision for the employment of military forces for CMO, translated into operational terms by a campaign plan, a formal structure, or a SOP for operational CMO staff coordination is even more important. Unfortunately, neither NATO nor U.S. doctrine nor KFOR SOPs provide specific guidelines for coordinating operational-level CMO for combined staff that is largely inexperienced or untrained for CMO. Nor is there a CMO coordinating structure such as a Combined Joint Civil-Military Task Force (CJCMTF) or Joint Civil Commission (JCC) as employed in Bosnia, although KFOR's Annex W calls for deployment of a CJCMTF, "if a founded requirement for a CJCMTF emerges."

The chart below helps illustrate how CMO missions at HQ KFOR had been split up among a number of directorates beyond J9, not just because of national interests played out at that level. While J9 conducted most civil-military liaison and provided practically all of HQ KFOR's CMO expertise and assessments, separate to this was a Civil Affairs directorate in charge of an independent group of two score or so French CIMIC officers largely dedicated to support of economic development. J5 provided operational planning and project management assistance to UNMIK on special issues, while J3 Provost Marshal conducted liaison with police forces, the Legal Advisor with UNMIK Legal Affairs, etc., all along lines of staff expertise. The Joint Implementation Commission (JIC), with the important job of transitioning the Kosovo Liberation Army into the Kosovo Protection Corps, has had only sporadic coordination with the J9 staff at the action officer level, as has the other staff.

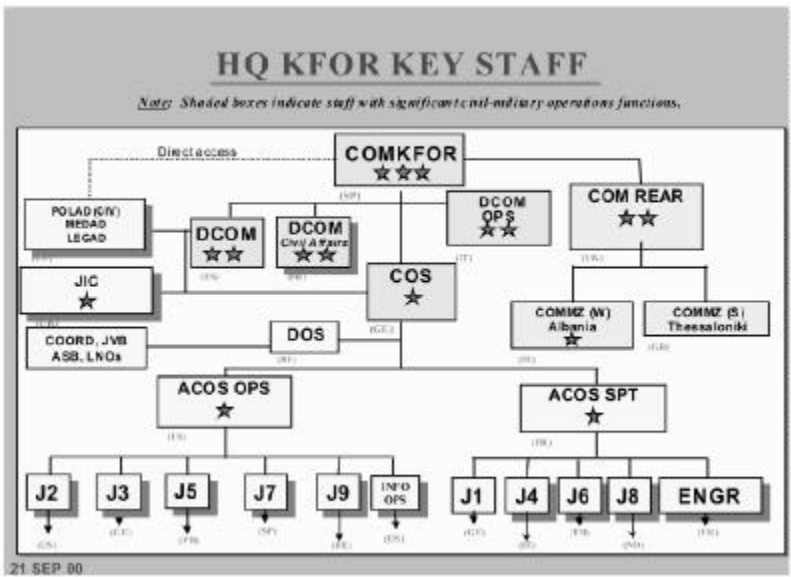

Figure 2. HQ KFOR Key Staff

With no clearing mechanism or steering authority, action officers at times worked redundantly (or even at cross-purposes) with the UNMIK staff. And not shown on the chart is the Kosovo Development Group—nearly 20 (non-CIMIC) officers sent by SHAPE who reported to EU offices within the regions. Its major economic development assistance tasks included reconstruction planning of technical and funding needs, development of local capacity for reconstruction implementation, and reconstruction project coordination.

Another striking observation of operational CMO in Kosovo: Although a CIMIC campaign plan was drafted during the first rotation of KFOR (KFOR1), it was not really implemented. (Many KFOR CIMIC officers had no knowledge that there was a KFOR CIMIC campaign plan.) Further rotations attempted to resurrect the CIMIC campaign plan at J9, but as before it did not receive the appropriate command emphasis, to the point where implementation at so late a phase became academic. Though not as systemically flawed as UNMIK, KFOR's record on passing on institutional knowledge during transfer of authority between KFOR rotations has not been infallible. Further, as reported by the MNB East G5 in May 2000:

KFOR has not provided a plan to coordinate and synchronize CMO activities between the MNBs...KFOR provides broad CIMIC guidance and intent along several lines of operations: freedom of movement, humanitarian support, public safety, civil administration, infrastructure repair, economics and commerce, and democratization. Measures of effectiveness and end-states for the lines of operation are not specified. KFOR produces a daily SITREP based on reports provided from each MNB and meetings are held at HQ KFOR biweekly between CIMIC chiefs. Assessments of the information and recommended/directed actions have not been provided...

CMO activities within MNB(E) are hampered by the absence of an overarching campaign plan and means for measuring the status and effectiveness of the CIMIC lines of operation at the municipal/maneuver unit level. The maneuver unit's focus is providing a safe and secure environment, and in executing that mission they perform limited CMO activities such as sponsoring town meetings, coordinating with international organizations/NGOs, etc. The focus of the Civil Affairs teams is performing extensive CMO activities along the CIMIC lines of operation to support the Task Force Falcon Commander's intent and the maneuver units in their AORs. The potential for disunity of effort where the CMO activities intersect and overlap exists because CMO actions are not synchronized by an integrated campaign plan. Furthermore, neither Civil Affairs nor maneuver units have been provided phased objectives with means to measure the effectiveness of CMO activities... An overall CMO campaign plan for MNB (E) does not exist. This is due in part to the lack of guidance and direction from higher headquarters in Pristina. Even though our teams are engaged in CMO activities on a daily basis, there is no clear statement of what the priority/

main effort actually is. This being said, many of the CMO activities are reactionary (based on the current situation) rather than deliberately planned and synchronized to attain an overall objective.

There is a second important reality to CMO in KFOR. Although UNSCR 1244 says an “international security presence with substantial North Atlantic Treaty Organization participation must be deployed under unified command and control,” the balkanized approach to CMO both at HQ KFOR and among the MNBs reflected overall problems in military unity of effort in Kosovo. HQ KFOR has been a de facto coordinating, rather than a command and control, headquarters. The MNBs are relatively independent and thus have approaches to CMO more in line with national political priorities and military operational styles. In addition, national contingents have often sought to involve NGOs or government-sponsored relief agencies from their own countries or regions rather than either adhering to the lead agency concept (in this case, UNHCR) for relief coordination, or based on actual needs in sector. Beyond inappropriate use of resources, this risked the impartiality of the military. On the other hand, there were occasions where CIMIC helped steer clear of excessive village chief or clan involvement in the selection of relief based on local politics rather than need, despite the absence of overall operational guidance.

As regards national approaches to operations, from a CMO standpoint, MNB(C) may have had the most appropriate approach in Kosovo to integrating CMO with PSO, based to a great extent on the British experience in Northern Ireland. The concept is that CMO is integrated into operations (especially security operations) and that every soldier in a peace operation has a CMO mission. Hence the small number of dedicated CMO personnel at MNB(C); a dozen or so CMO officers mainly at G3 (CMO) at Brigade and battalion HQs. Presence patrolling is conducted almost entirely dismounted, especially in built-up areas, and through the same villages and neighborhoods by the same soldiers, much like beat cops, with an emphasis on direct contact with local civilians. “This is what we do well,” said Brigadier Robert Fry, MNB(E) Commanding General, in January 2001. “What the Americans do well is provide a guarantee of overwhelming force. This [situation] plays to our strengths in ways that it does not necessarily play to American strengths.”¹¹ The Norwegians and Swedes, who have also had extensive peacekeeping experience under the U.N. flag, applied similar methods.

Unlike most KFOR soldiers, however, Scandinavian troops tended to have full-year tours rather than for 6 months. This contributed to a great deal of operational stability and solid civil-military relations. Although longer tours of duty for CIMIC personnel are operationally ideal, political or administrative realities (e.g., for U.S. Army CA forces under Title X of the U.S. Code) make this difficult. (Still, a counter-argument is that longer tours ultimately economize demand on U.S. CA forces and ease, for example, tensions with these Reservists' civilian employers, as tour frequency would lessen.)

MNB(N) has been French-led and employed as many as 80 CIMIC personnel. As in all the MNBs, the French operate CIMIC centers (not necessarily to be confused with civil-military operations centers, or CMOCs) throughout their area and place emphasis on assisting locals through these venues to obtain assistance from either the UNMIK municipal administrators or NGOs/PVOs in the area. With a much more difficult and explosive situation, particularly in the Mitrovica region, MNB(N) soldiers, reinforced at times by other MNBs, maintain a more standoffish posture with the locals. They have been criticized for apparent unwillingness to place themselves in danger on the behalf of Kosovar Albanians, but were even-handed in responding to the highly risky and politically charged environmental disaster in the Zvecan lead smelter in August 2000—a capstone KFOR-UNMIK joint security operation.

MNB(W) has been headed by the Italians, who have had the least CMO experience among the MNB lead nations. With about 40 CIMIC personnel, the Italians have applied CMO much the same way the French do, with some concentration on anticrime operations with the assistance of the *Carabinieri*. In addition to dealing with the inter-Kosovar Albanian political violence and criminal activity which peaked in the months before and just after the municipal elections, and in addition to intense illegal weapons search and seizure operations with UNMIK Police, MNB(W) performed a number of military civic action activities, mostly in support of humanitarian relief and reconstruction efforts. MNB(W) also deployed company formations with anti-riot training which were very useful in containing civil disturbances in Mitrovica January-February 2001.

MNB(S), which has employed as many as over 100 CIMIC personnel, concentrated on its unique interpretation of reconstruction (i.e., housing, public service, and utilities infrastructure) driven by the German strategic interest of repatriating as many Kosovo refugees currently in

the Federal Republic of Germany as soon as possible. Their accomplishments have been impressive—the communications, transportation, and agricultural infrastructures in the Prizren region are among those in the best condition in Kosovo. In addition, the Germans have tended to employ their forces, such as engineers, more in direct support or supervision of reconstruction and infrastructure in military civic action projects. This seems to be due to the longtime German experience in civil emergency operations planning under the Wartime Host Nation Support concept of the Cold War.

MNB(E) used its nearly 60 U.S. Army CA personnel (reduced to about 40 in 2001), plus other CIMIC soldiers, to facilitate civilian agency success through programs such as the Village Employment Rehabilitation Program with the U.N. Development Program. In addition to conducting over 500 village and school assessments and maintaining a database, CA teams performed hearts-and-minds projects designed to promote overall military mission legitimacy with target audiences (linked with PSYOP and other information operations in sector through, for example, the School Adoption Program). They have also assisted UNMIK- and NGO-led capacity-building projects such as business seminars for small and medium enterprise owners (again, considering CA personnel are Reservists, many of whom have business experience of their own). And, as in all other MNB sectors, the U.S., Polish, Russian, and Greek forces provided direct and indirect support of the myriad humanitarian relief activities, many of which were funded by government agencies from their own countries or by like-language NGOs/PVOs.

Next to MNB(N), MNB(E) has had the most difficult situation regarding Kosovar Serbians and other minority communities pocketed throughout the region, compounded by the activities of KLA-related paramilitary forces stirring up tensions with the FRY in the Presevo Valley and the Former Yugoslav Republic of Macedonia. CA teams became directly involved in conflict negotiation and crisis response when riots broke out in Strpce, Vitina, and Kamenica over the perceived failure of KFOR troops to protect Kosovar Serbians and other minorities. Unfortunately, however, their involvement and consideration in the operational level planning and coordination of UNMIK-led strategies to combat this key problem in Kosovo were somewhat limited.

The embarrassing situations involving the behavior of certain combat units toward civilians in early 2000 reflected the inadequate training and preparation for PSO. It reinforced an important point brought up

earlier about appropriate task organization for CMO-intensive peace operations. Following the successful deployment of the 49th Armored Division of the Texas National Guard in Bosnia, the U.S. Army decided that about 50 percent of its combat formations to be deployed to the Balkans would be from the National Guard. By virtue of their civil-military tradition and civil disturbance training, they are in many ways better suited to post-conflict peace operations. It may have also been useful during the early phases of the operation, to deploy more military police, combat and civil engineers and, of course, CA/CIMIC forces on the ground.

It also reflects that a number of U.S. tactical commanders still maintain a separatist attitude towards CMO, partly due to a visceral resistance to PSO which may, however, be changing as more and more officers point out the added-value effects of PSO deployments to training and readiness, as well as developments accelerated by the aftermath of September 11, 2001.¹² As recommended by the 411th Civil Affairs Battalion Commander in the summer of 2000, “CMO must be an integral part of the maneuver commander’s plan and the Civil Affairs team must be part of the that planning process. With a coordinated effort, CA can directly and/or indirectly assist the maneuver commander achieve the tactical objective.” Again, fortunately, CMO is gaining greater importance as an operational component, and operational doctrine and senior officer and command and staff training in the U.S. Army has begun to reflect that.

Still, perhaps another indicator that CMO is not yet seen as a key operational determinant, rather than just another battlefield operating or support system, has been the continued U.S. obsession with force protection. When U.S. troops left Camp Bondsteel and other locations in relatively large, heavily armed, mounted formations for force protection reasons, their appearance as such often intimidated as much as reassured the local populace. It communicated the ostensible American fear of casualties. It has been remarkable, considering force protection constraints (such as the requirement for four-person CA teams to operate in two tactical vehicles with two persons each), that these teams accomplished as much as they did. Unable to multitask, team members had to work sequentially with all other team members, always donning the familiar body armor, which in addition to intimidating local civilians, made it difficult for them to distinguish CA soldiers from the combat troops. Although other U.S. Army Special Operations Forces

under the operational control of the Task Force Commander had not been under these constraints, CA forces were.

CMO at the tactical level could nonetheless be described as a success story. KFOR CIMIC teams were instrumental to the coordination of humanitarian relief, capacity-building and reconstruction efforts, as well as to the registration and elections process in Kosovo. In every region, the level of cooperation and enmity between KFOR and UNMIK at the municipal and regional levels, as reported by both KFOR CIMIC officers and UNMIK officials, was quite strong. No doubt KFOR has been instrumental to leveraging the success of the international mission in Kosovo, albeit often doing so by risking the culture of dependency between KFOR and UNMIK and between KFOR and local communities.

This could have been tempered by better coordination and more explicit CMO guidance from HQ KFOR. Again, as the 411th CA Battalion Commander observed:

CMO capabilities and activities in each MNB vary based upon the regional situation and CIMIC personnel strength, skills, training, and national doctrine. Those differences present significant difficulties when CMO coordination between MNBs is considered. However, they also present potential opportunities to level unique resources to meet specific regional needs. The process for collecting and transferring information required to identify needs exists—more emphasis on assessments and coordination is needed to achieve a common end-state that is defined by measures of effectiveness at the regional level.

Emerging NATO CIMIC doctrine under the current draft of SHAPE AJP-9 is undoubtedly a step in the right direction and begins to provide an overall concept for the application of CMO for multifarious NATO forces deployed in a joint-combined PSO environment. With further development, especially in operational and tactical CMO concepts and in CMO techniques and procedures, AJP-9 should go far to fulfill this need—for NATO forces.

This is even more relevant at the operational level, considering especially the varying levels of training and background qualifications of CIMIC

officers from the contributing nations. KFOR CIMIC liaison officers had often very good supervision and guidance from the Chief Liaison Officer and played a crucial role in, for example, coordinating the repair and maintenance of the dilapidated Kosovo power network. However, the many less experienced and qualified liaison officers working in more political areas would have benefited from a reference outlining their mission and providing overall operational guidance in the form of specified and implied tasks, with CMO success indicators to measure progress and provide guidelines for reorganization and retasking. Such a reference would have also provided a vehicle to incorporate the observations and lessons of their predecessors. It is critical for these officers, whose mission scope often goes well beyond typical liaison functions, to have a firm grasp of their mission, how they fit into the overall CMO scheme of maneuver, and under what CMO rules of engagement they should operate, regardless of leadership types. In addition to articulating these roles and responsibilities in NATO CIMIC doctrine, SHAPE and the contributing nations need to more consciously assign CIMIC officers with greater PSO and combined/joint staff experience, CMO-related training and skills, experience in working with international organizations/NGOs, and English-language oral and written communications skills. In addition, deep battle troop-to-task analysis of specific CMO skill sets for specific phases should have been conducted in order to allow SHAPE to coordinate contributing nation identification of personnel at least 3 months before the start of the next deployment rotation.

The end of the second winterization operation and the departure of many NGOs in the spring of 2001 signified the end of the relief-intensive phases of UNMIK. UNMIK then moved towards a provincial election with defined central institutions to begin the final phases of transferring public administration authority and responsibility to the local leadership (approaching fulfillment of UNSCR 1244's envisioned substantial self-autonomy). With this change, the role of KFOR as an enabler of UNMIK success also changed and therefore the kind of CMO personnel required was different. For example, those who could facilitate political, public administration, and economic capacity-building instead of those who can coordinate humanitarian relief logistics became more useful and more difficult to find.

At any phase, the crux of facilitating unity of effort in a peace operation is establishing and maintaining transparent information flow both between

and within the civilian and military communities, early and often. As mentioned above, there were a number of very good mechanisms for civil-military coordination and information sharing in Kosovo. Although each could have improved, the real challenge was coordinating these mechanisms. A comprehensive operational architecture for civil-military unity of effort in Kosovo was also lacking. As mentioned, this is not adequately addressed in the Brahimi Report, nor covers civilian and military communities in either NATO or U.S. doctrine, past or present. And although CIMIC centers existed at the tactical level, they were not CMOCs in the fullest sense, and there was no CMOC, CJCMTF, or similar process at the operational level to actively coordinate and help civilian executive leadership translate political intentions into operational action, to manage and phase the plethora of interdisciplinary relief to reconstruction activities in Kosovo, to synchronize them with military efforts, and to measure and evaluate progress.

Indeed, the HCIC was a very good information sharing and database management platform, but it was no CMOC. A year into the mission, the J9 established a KFOR CIMIC liaison office in the UNMIK building to enhance the effectiveness of the CIMIC liaison mission. First, the office provided a one-stop shop for UNMIK clients and thus intensified information and coordination flow as well as problem-solving turnaround. Second, by doing so, it bolstered the presence of KFOR, albeit discreetly, and thus CIMIC and KFOR's legitimacy there. Third, it improved real-time coordination among KFOR CIMIC liaison officers. Fourth, it provided a soft information coordination complement to the HCIC. Last, because the contact information remained the same (phones, e-mails) and local coordination databases are independent of personalities, it led to greater continuity of liaison and ease of transition despite continual rotations of liaison officers. Even after more than 2 years, however, the full potential of this coordinating mechanism was not yet realized.

The CIMIC report: For many reasons, this daily report was the most effective yet least understood item in KFOR's CMO toolbox. Beyond the report's main purpose to inform SHAPE and the KFOR staff on IC activities in Kosovo, the report turned out to facilitate civil-military unity of effort. First, it promoted CIMIC mission legitimacy by providing a single source of information and assessment within an overall context on the activities of UNMIK and the MNBs among all pillars and departments and around the region. (It also provided transparency to

UNMIK on what KFOR was reporting about UNMIK.) Second, it enabled cross-pillar, interdepartmental, and inter-staff coordination, not just because the CIMIC report had been distributed among executives and staff chiefs, but most importantly among IC project managers often starved of the necessary information to solve problems, manage and coordinate projects effectively, and keep things moving. (This is of similar value to other KFOR and MNB staff officers). Helping to mitigate this serious operational shortfall, the CIMIC reports have thus been an important multiplier for CIMIC support of the KFOR end state.

Third, the CIMIC report would have been a vital influence operations tool, beyond enhancing knowledge, in helping to shape operational perceptions among UNMIK staff and key players. This process was interrupted in the critical months before the October 2000 municipal elections by SHAPE's instruction to suspend distribution to UNMIK, due to the (technically correct) enforcement of a policy that no NATO document, regardless of classification, is releasable to non-NATO entities without the expressed permission of the North Atlantic Council. After nearly 2 months of interruption, SHAPE authorized resumption of distribution within certain guidelines—i.e., the document could not be provided to civilian agencies outside Kosovo. Unfortunately, much momentum was already lost, as the KFOR3-4 rotation occurred just as redistribution was being approved. Even though J9 reworked and improved the document considerably during KFOR5, and posted it in the UNMIK Intranet Web site, it was not well advertised, difficult to find in the site, and not regularly updated.

There were some valuable lessons. First, because transparency between the civilian and military communities synthesizes civil-military unity of effort, a general policy and guidelines for distribution of CIMIC reports and other NATO information products in such operations should be built into coordinating CIMIC doctrine. Second, to improve CIMIC unity of effort, HQ KFOR would have been wise to have J9 collect report inputs from other HQ KFOR staff with CMO responsibilities. This would maximize the advantages of the CIMIC report for SHAPE, HQ KFOR, and UNMIK. In addition, it would be an excellent means to communicate KFOR's CMO operational focus to civilian and military players. Finally, it would provide an important executive management tool to help coordinate operational CMO among the HQ KFOR staff.

The CIMIC report case is a good example of the difficulty of information sharing through publication of reports (and there have been scores of

them in Kosovo, many of them redundant and very few of them synchronized). Report synchronization would be an excellent means of improving soft information transparency, especially through networks, Web sites, and other information technologies to create, for example, a Kosovo reports Web site. The trick, when objectively feasible, is to wean reporting organizations away from exclusivity and a sometimes excessive concern with information security, especially when it is the result of the information-is-power syndrome prevalent in civilian and military bureaucracies.

Besides, information transparency, if appropriately managed, would also enhance CMO's ability to support two central military missions in a PSO: security and information operations, both of which have underdeveloped CMO roles.

CMO and Security Operations

AJP-9 describes two mission areas—support to the force and support to the civil environment. As mentioned, the primary military role in Kosovo or any other PSO is to provide overall security. In terms of supporting the force, CMO has a crucial role in supporting the security mission, mainly by providing information gained through CMO to the intelligence effort and through CMO support of the rule of law and joint civil-military anticrime operations.

There are some U.S/NATO doctrinal discussions of the role of CA/CIMIC in support of intelligence operations (less so with NATO doctrine). However, there is little on how CA/CIMIC can support security operations, nor specific operational or tactical lines of coordination in regard to support of intelligence operations. Yet, especially in PSO, most relevant information is derived not from signals/electronic or other high-tech means of intelligence-gathering. Rather, it is derived through the labor-intensive process of personal observation and contact. About half of information on the ground political situation or persons of interest (especially international staff) can come through CMO. A few CIMIC liaison officers in the early rotations provided formal and informal reports and assessments on security-related matters to the intelligence/operations staff at HQ KFOR, to include a CIMIC assessment of the minority community security situation. Likewise, they involved themselves in KFOR-UNMIK discussion of joint security issues such as minority community security or political violence. They

also played a key role in facilitating information sharing between KFOR and UNMIK security staff. This was, however done at their initiative and by virtue of their experience, training, and sensitivity to the criticality of this CMO implied task. It was not necessarily repeated in further rotations.

The operational relationship between CMO and intelligence is highly sensitive, yet unavoidable in a PSO for the reasons suggested above. While the U.S. Army Civil Affairs community insists that, in order to protect the credibility of their operations, CA personnel should not be involved in intelligence gathering in any way, the intelligence community may be moving towards cultural intelligence.¹³ Regardless, these two communities need to establish doctrinal divisions of responsibility and operational lines of coordination to help each other while staying out of each other's way. If not, intelligence operators in the field could also place CA/CIMIC forces and their mission at great risk. Specifically, both the J2/G2 and J9/G5 should have guidance to pre-coordinate Commander's Critical Information Requirements (CCIRs) with Primary Intelligence Requirements (PIRs) and discreetly share information.

Because of CA/CIMIC's unique network and access to information, it could be an important provider of insights on the political-military situation as well as a conduit of operational translation of political-military imperatives and guidance. Establishment of an Operations Analysis Branch (or Task Force) at HQ KFOR, similar to what the Allied Rapid Reaction Corps used during KFOR1, should have been institutionalized. Led by the political advisor, but including J2, J9, and information operations plans and operations staff, it could have jointly analyzed the political-military situation for the commander and articulated his guidance to the MNBs and other operators in the field. The reality at HQ KFOR has been different. The Political Advisor, J2, and J9 coordinated or exchanged information occasionally, as situations have dictated. Very few threat or risk assessments, for example, prepared by KFOR J-2X consciously included or solicited political-military or CIMIC inputs. Yet, intriguingly enough, a great many of these analyses either had a high political-military or civil-military content or, even more ironically, were assessments of political-military or civil-military issues or events.

CA/CIMIC can also provide invaluable support to the force through support to the civil environment missions, particularly in helping UNMIK

establish the rule of law through an effective justice and criminal prosecution system and in anticrime operations. Until mid-2000, CIMIC officers, working with Legal Advisor officers, helped UNMIK establish a courts and criminal prosecution system. The legal expertise of the Legal Advisor complimented the eclectic operational and civil-military sensitivity of CIMIC, as well as fostered the necessary linkages with political and other relevant civil administration staff. When the only CIMIC officer with a legal background left the mission in the summer of 2000 without a replacement, the Legal Advisor completely took over this civil-military task. Likewise, J9 maintained liaison with UNMIK Police until the CA soldier with a police background departed at the start of KFOR3 and the J3 Provost Marshal took up the mission. When UNMIK established its Police and Justice Pillar in mid-2001, J9 was unprepared to provide CIMIC liaison officers with the appropriate background.

The role of CMO in support of anti-crime and anti-terrorism operations, as with intelligence operations, has not been well understood or defined at KFOR, nor all that much better among U.S. forces. This is especially true when dealing with organized crime. Organized crime and low-level terrorist networks are not only imbedded in the cultures of many ethnic groups in the Balkans, e.g., the clan culture and informal laws and norms of the Kosovar Albanians. It is well networked with regional and international organizations. In the various UNMIK-led initiatives to protect minority communities and build their confidence to remain in Kosovo, the CA/CIMIC role has been minimal, especially in terms of crime mapping, information gathering, or information operations, or for promoting civil-military unity of effort. UNMIK Strategic Planning identified urgent need in 2000 for multidisciplinary civil-military criminal analysis teams at both the operational and tactical levels, but they never materialized.

J9 had no consensus on the conduct and database formatting of village assessments by tactical CIMIC elements or surveys of petrol service stations. UNMIK felt CA/CIMIC elements could have been very helpful to assess the construction of housing and commercial facilities for property registration and tax purposes in cooperation with municipal administrative offices, but more so to minimize illegal, unsafe, or environmentally hazardous construction. Assistance to this effort, however, was also incidental. (As in Bosnia, petrol stations in Kosovo are often front operations or coordination centers for organized criminal activities such as the drug trade, money laundering, and stolen vehicles

and fuel. In a stretch of Kosovo road less than 30 km between Pristina and Urosevac/Ferizaj, by the autumn of 2001, the number of operating fuel service stations expanded to 17.)

Just as with intelligence operations, a clear division of responsibilities and techniques and procedures need to be determined *a priori* in CMO support to both judicial intervention and anticrime operations, for many of the same reasons. Keep in mind that a great many U.S. CA personnel have legal and law enforcement backgrounds as civilians. Especially considering future military PSO in the wake of September 11, 2001, this resource should be exploited, in addition to institutionalizing the complementary relationship between CIMIC and military legal and police staff to help establish an effective criminal prosecution system.

One further note: There was no institutional involvement of J9 in the KFOR JIC and in the conversion of the KLA into a civil emergency preparedness and disaster relief type organization. Reservist U.S. CA forces, with their keen sense of civil-military relations in a democratic society, as well as NATO officers with Partnership for Peace military-to-military mission experience, would have been ideal consultants to the KPC under the JIC. Yet, none of the former and very few of the latter were assigned to the JIC.

CMO and Information/Influence Operations

More than with security operations, CA/CIMIC assets in Kosovo were underutilized in information operations, particularly at the operational level. The overwhelming concentration for KFOR information operations was on use of PSYOP and Public Information assets to determine operational priorities and messages and to plan, organize, and execute information operations campaigns. As in U.S. doctrine, information operations tends to restrict itself largely to offensive and defensive operations involving information systems, rather than a more holistic approach incorporating the full spectrum of influence operations, of which CMO as well as PSYOP should be a part.

Again, at their initiative, some J9 officers worked closely with KFOR information operations and PI staff. They helped maintain a liaison and facilitated information sharing with both UNMIK Department of Public Information and with other key international interlocutors at KFOR-sponsored information operations working group meetings. In addition,

they became associated with the UNMIK Strategic Planner's initiative to synchronize information and data formats, in this case to facilitate information transparency among the international community. In one instance, a KFOR CIMIC liaison officer was at the heart of planning the highly risky but highly successful October 2000 Public Outreach Initiative, conducted personally by the SRSG at various town hall meeting settings to legitimize the upcoming municipal elections and lay the groundwork for the democratization process. His ghostwriting of the action plan is a typical case of a KFOR CIMIC liaison officer performing atypical, non-liaison tasks.

The international civilian community, as well as the local staff working with them, are critical opinion leaders, sensitive to the pulse of everyday life and the public mood, and are thus themselves a key target audience for information operations—astride the operational center of gravity of the mission. This is not to suggest that UNMIK should have been manipulated. The point here is that the full value and potential role of the international civilian community in perception management and influence operations was unrealized. A good example of this is the near-hysteria during the winter of 2000-2001 over the possible environmental and public health effects of contamination by the NATO use of depleted uranium munitions. With all the attention paid to the international and (eventually) local media, the substantial international community in Kosovo, both as a legitimately concerned community and an important opinion group, was almost overlooked.

There is significant operational value added in close information operations; CMO synchronization, chiefly because, as pointed out in regard to security operations, CMO at the operational level enjoys a distinct advantage to see the information landscape and help craft strategies, assess risks and analyze courses of action, and develop messages. This is mainly by virtue of its liaison with the UNMIK staff or informal contacts via the well-networked rumor mill of both international and local staff. In this regard, CMO estimates and assessments can contribute greatly to the information operations campaign process in terms of messages, target groups, media selection, and monitoring key group/leadership reactions to information operations campaigns. Moreover, CMO can contribute enormously to joint civil-military information operations synchronization and information transparency among designated and non-designated information operations players. At the tactical level, in coordination

with PSYOP and public affairs operators, CA/CIMIC operators can be a multiplier as well as a direct contributor through civil information activities as part of influence operations. At the operational level, CMO's central role is in the collection and management of soft or soft-power information, or what could be simply called knowledge. The KFOR CIMIC meeting is another good example of how CMO can help shape the information operations battlefield through its contacts with information and knowledge brokers, although the meetings only sometimes went beyond show-and-tell discussions of topical issues. The most efficient vehicle, however, was the CIMIC report. In addition, one should not overlook the value of coordination with security staff as regards, for example, information on the ground situation. Thus, the CMO link between security and information/influence operations. Again, in PSOs, the battlefield is essentially the hearts and minds of various groups contingent to key tactical, operational, and strategic centers of gravity, and information is the terrain of such power. CMO is in the hearts-and-minds business.

Live-Lesson Learning

The Brahimi Report makes an excellent point on live-lesson learning, namely:

*Lessons learned should be thought of as a facet of information management that contributes to improving operations on a daily basis. Post-action reports would then be just one part of a larger learning process, the capstone summary rather than the principal objective of the entire process.*¹⁴

UNMIK has not been different from any other U.N. mission in that there has been no lessons learned or best practices staff dedicated to capturing acquired operational knowledge and instituting procedural improvements in the field. Nor is there any formal method for staff in general to capture and collate this knowledge. KFOR's system is more organized, but not by much. Nonetheless, military staff are inherently more disciplined in this matter.

It is also important to keep in mind that a lesson learned is just a lesson until the identified improvement is implemented. CA/CIMIC staff in particular, due to the sensitivity, complexity, and knowledge-intensity of their work, require greater transition times and more thoroughly

organized hand-overs between successive rotations than most staff. In this regard, CMO could be instrumental in facilitating joint live-lesson learning with the IC. This could be another major role of an operational-level CMOC in conjunction with the HCIC, the UNMIK Strategic Planner, and the U.N. Military Liaison staff at the Situation Center. Just as with a Kosovo reports Web site, a Kosovo lessons Web site with input format templates could have been established to cast a wide net for lessons among all kinds of players at all levels.

Perhaps the most valuable lesson of CMO in Kosovo is that, from an operational standpoint, it is at least as important to have adequately trained and qualified personnel as it is to have up-to-date doctrine. Soldiers often forget doctrine. However, they less often forget the training that shapes their instincts in the field. There is a tendency, particularly at the agency level, to focus after-operations reviews on doctrinal changes. The first question, however, is whether anyone on the ground is actually reading or applying the doctrine, or even if they are aware of it. Six months after publication of the latest version of FM 41-10, for example, U.S. Army CA officers at HQ KFOR were not even aware that it had even published, let alone obtained a copy (which took another four months due to Web site accessibility gateways). Second, the most elegant and precise doctrine is of limited use to the uninitiated—and the field is not always the best place to learn the complex concepts of CMO while trying to implement them.

At the operational level, this takes on even greater significance. Yet, CA/CIMIC officers have little advanced training opportunities beyond basic orientation courses and training, such as that provided by the U.S. Army Civil Affairs and Psychological Operations Command (USACAPOC) at Ft. Bragg, NC or the NATO CIMIC School at Oberammergau, Germany. There is a definitive need for advanced, interdisciplinary training in environments including both military and civilian practitioners of peace operations in environments that not only provide opportunities for cross-familiarization and cross-pollination, but also the creation and exercise of joint procedures and plans for peace operations deployments. Such training would translate into improved interdisciplinary coordination and cooperation in the field, a shorter and less steep learning curve in the critical early phases of peace operations, and the growth of more operationally well-grounded future peace operations executive leadership, both civilian and military.

On a more practical level, to use a baseball metaphor, even the best and most experienced CA/CIMIC officers have two strikes against them when they first report to many of the commands they support. First, they are not one of them (meaning they are either not in a combat specialty, not from the commander's unit, and/or are a Reservist). Second, they are involved in something many commanders do not inherently understand and feel uneasy about. The third strike is when a CA/CIMIC officer asks what he ought to be doing, rather than explaining what he can do to support the force and the extended mission (which implies an ability to conduct mission analysis and understand the CMO mission). Therefore, the first CMO mission is to establish legitimacy with the supported command. The untrained, unqualified, and inexperienced CA/CIMIC officer is not as likely to connect with the unit to become a multiplier and an enabler.

The Disappearing U.S. Operational Civil Affairs Presence

U.S. Army Civil Affairs presence at HQ KFOR at the outset of the Kosovo operation was robust—nearly two dozen CA troops were deployed under mobilization orders with the ARRC in Rotation 1. That presence decreased to about a dozen in Rotation 2. In Rotations 3 and 4, it plummeted to three. In Rotation 5, it dwindled to one, rising slightly in Rotation 6.

The reasons for this drop had more to do with the institutional peculiarities of USACAPOC and particularly the Special Operations Command, Europe (SOCEUR) in Stuttgart, Germany. Bureaucratic politics and budget-driven deployment limitations drove the determination of the CA footprint, rather than operational needs (not well documented by KFOR J9 to SHAPE). Yet, U.S. CA operational presence was even more scrutinized than the tactical CA forces at MNB(E). With every rotation, the U.S. CA footprint at HQ KFOR had to be validated for the next rotation as if from scratch. It was one thing to have to rejustify in detail even a mere 3 U.S. CA soldiers out of 25 to 30 NATO personnel at J9 (about 10 percent). It was another to explain the obvious, such as the fact that these personnel were in support of a core CA mission, namely (per Joint Publication 3-57 and FM 41-10), to provide CA support to civil administration. When interviewed by a visitor from SOCEUR in

September 2000, the (non-U.S.) J9 Chief Liaison Officer openly expressed J9's appreciation of the U.S. CA value-added.

For one, he argued, they are among the only trained CMO personnel at HQ KFOR. Second, they bring all the other advantages that U.S. Reserve CA forces bring at the tactical level (and more, because of their relative experience compared to most tactical CA personnel) by virtue of their civilian education and background. Third, their European counterparts, most of whom in addition to having neither CMO training nor CMO field experience nor civilian experience, often have little or no previous deployment or PSO experience, or theater-level staff training or experience. Last, with the exception of an occasional British officer, they are the only native English language speakers working in a NATO field headquarters whose operational language is English.

Part of the solution to this is, as with the CA forces attached to Task Force Falcon, to require the U.S. CA team at HQ KFOR at each mid-rotation to provide a written assessment, endorsed by the J9, to re-validate the U.S. CA contribution to SOCEUR (and to SHAPE) based on the mission already identified. More than presenting an argument for their *raison d'être* and a troop-to-task analysis, it should identify specific skill sets that the next rotation of CA personnel should have to support the upcoming rotation's operational CMO mission.

Regardless of the operation, the U.S. contribution to operational CMO in a multinational setting, in terms of both operational and political value-added relative to the low profile of CA forces, should not be overlooked.

One More Lesson: The Role of the NCO in CMO

Due largely to the nature of operational CMO and the sensitivity and complexity of the HQ KFOR CMO mission, CMO tends to be officer-intensive, especially at the operational level. Still, there are many opportunities for non-commissioned officers to contribute. CA/CIMIC operations NCOs would, for example, be very helpful facilitating operational CMO and running the CIMIC Liaison Office, particularly in managing information traffic flow, performing triage for incoming requests for information and assistance, and facilitating coordination among liaison officers. Unfortunately, KFOR J9 NCOs have been used largely for administrative duties. This is part due to the lack of doctrinal guidance

and experience in NATO and most contributing nations. It is also due to different national perceptions on NCO roles and responsibilities.

Not providing these NCOs the opportunity to become contributors to operational CMO, however, is not just a disservice to the NCOs, it is squandering a valuable resource to enhance CMO effectiveness. Many of these NCOs have highly useful information technology skills. J9 could have, for example, rotated J9 NCOs to perform as CIMIC Operations NCOs by design. Under the supervision of the senior NCO and the Chief Liaison Officer, they can receive on-the-job training at the CIMIC liaison office downtown. One method is to have these NCOs prepare and update a CMOC or CIMIC coordination center SOP as well as other operational and administrative references for the liaison officers, and to document lesson-learning. SHAPE J9 should examine the role of the NCO in CIMIC operations and consider doctrinal inclusions as well as a program of instruction for nations to train CIMIC operations NCOs, either at the NATO CIMIC Course or national schools. SHAPE J9 could also develop a program of certification by correspondence for those NCOs who cannot attend the NATO school.

Managing Expectations

More than any other aspect of military operations, CMO is more art than science, comprised almost entirely of variables with little or no controls—particularly at the level where all the ways, ends, and means, both civilian and military, of international PSO come together. The most important variables are the civilian entities with which the military must work to fulfill its paradoxical exit strategy of becoming more involved in a PSO in order to extract itself from it.

Consider the hierarchy of the level of unity of effort shown below. As the level of unity effort rises, the complexity of the concept of operations and sophistication of command and control structures decreases. What increases, however, is the level of information transparency among the players. This is a useful exercise, not just in understanding the polemical differences among terms. More importantly, it suggests that, from a civil-military standpoint, reaching higher levels of unity of effort are unrealistic in many cases. In fact, however, they may not even be necessary. In the case of complex emergency operations such as during the first phases of Kosovo, interoperability may be the most plausible

level of unity of effort. Interoperability, however, requires certain compromises that, in addition to carefully defined operational concepts of civil-military interaction, must be constantly brokered at both the decisionmaking and coordinating levels.

Peace support operations, by their nature, are even more of an extension of politics by other means than war. For that reason, the military's typical fixation on utopian-like end-states and exit strategies rarely squares with the reality of the constantly fluctuating politics of complex emergency operations that lapse into an international transitional administration in a post-conflict environment. Thus, a critical role of CMO is not just to help manage the mutually dependent civil-military relationship, but to help both sides manage their level of expectations towards the other. This is particularly true as the political imperatives and organizational and resource requirements change as the international presence evolves from relief to capacity building to reconstruction and from stability operations to peace building.

And although there is great importance in sound doctrine, operational guidance, and civil-military enabling structures and processes, it ultimately comes down to the quality of the players in the field. In addition to adjusting doctrine and organizational structure to be in greater tune with the new realities of civilian-lead humanitarian relief operations and nation-building, what CA/CIMIC force providers like SHAPE J9 and USACAPOC must concentrate on is making sure that the people they select to perform CMO have the right background and the right training for the right phases of the mission.

A Civil-Military Unity of Effort Hierarchy

- **Integration**—bringing together all civilian and military components for a unified purpose into a unified activity under unified authority.
- **Coordination/Synchronization**—harmonious adjustment of respective actions for a generally common purpose.
- **Interoperability**—the ability to interact according to agreed-upon methods in the pursuit of common goals with varying objectives; such ability depends on information-sharing and communications technology compatibility as well as knowledge

of each other's goals and objectives, corporate culture, operating principles and terminology—i.e., *transparency*.

- **Collaboration/Cooperation**—joint effort in accomplishing a common activity as dictated by situation.

Because much of PSO is led or conducted by civilians, especially in transitional administration situations, this radically alters skill set requirements for CA/CIMIC forces. The good news is that the requirement for CA/CIMIC specialists to perform nation building may be diminishing. The not-so-good news is that the demands on CA/CIMIC generalists, particularly at the operational level, are increasing rapidly. The kind of people required to perform or coordinate operational-level CA/CIMIC must not only possess greater PSO and combined/joint staff experience, but also CMO-related training and skills, political and cultural sensitivity, and (English-language) oral and written communications skills. They must be good staff officers and know something about risk assessment, mission analysis, and course-of-action analysis. Beyond this, they must be knowledge and information managers, public administrators, logisticians, engineers, legal and law enforcement specialists, and educators. (It also helps to be a superb networker and coordinator.) More than just being structured for success with the appropriate doctrinal and operational guidelines and training, they must possess interpersonal skills and an openness and sensitivity to their mission that cannot be taught. They must be enablers as much, if not more, than technical experts must. Between the military civilian worlds they simultaneously inhabit, they must be engines of synergy, fueled by knowledge and information.

Because CMO is more art than science, it is something its practitioners simply either grasp or fail to understand. And nowhere is this truth more important than at the operational level, where the success, actual or perceived, of a PSO hangs in the balance of unity of effort. Among all the points and recommendations of this chapter (summarized below), one stands out: If the KFOR experience should be teaching us anything, it should be teaching us that complex civilian-led post-conflict efforts are challenging CMO to go to new levels. If the professional CMO community is not prepared to take up this challenge and prepare itself, in atypical military fashion, for the next peace rather than the last war, it risks the failure of not just the mission of one, but the mission of all.

Main Points

- Civilians—not the military—lead complex international post-conflict relief and peacebuilding efforts. The role of the military, beyond security, is to enable the success of these efforts using its comparative advantages.
- While the military focuses on reaching clearly defined objectives through linear operational progressions under a more unified command and control structure, civilian organizations are concerned with political resolution through nonlinear processes, consensus-building and bargaining. CMO plays the main role in harmonizing these divergent approaches.
- Civil-military unity of effort at the operational level is at the center of gravity of complex international PSO—CMO plays a crucial role to facilitate both IC success/legitimacy and the military end state, from relief to reconstruction.
- Challenges to this unity of effort, both between and within KFOR and UNMIK, have been substantial and multifarious. In the case of KFOR:
 - HQ KFOR is a coordinating, vs. command HQ: MNBs follow national over NATO priorities;
 - CMO is too big for CIMIC and is split up among largely uncoordinated staff directorates with CMO-related tasks;
 - An operational CMO campaign plan which provides guidelines for CMO coordination or for tactical CMO must be implemented.
- Civil-military coordinating mechanisms were mixed: The HCIC and information-sharing initiatives were promising, but the CIMIC counterpart to coordinate knowledge is weak—there is no theater CJCMTF or CMOC.
- Nonetheless, KFOR CMO has compensated well for the inherent weaknesses of the civilian transitional administration, to the benefit of all.

- Training and quality of CA/CIMIC personnel is more important than sound doctrine. Information transparency is key to their success as enablers.
- The CMO role in security and information operations is underdeveloped.
- The IC is at once a critical medium and audience for influence operations.
- Live-lesson learning is a form of knowledge and information management to promote success *during* operations and to improve staff transition.
- U.S. CA forces play a critical operational CMO role.
- CA/CIMIC NCOs are a valuable but largely untapped resource.

Major Recommendations

- Joint/combined operational level CMO doctrine which focuses on civil-military unity of effort needs to be fully developed among DPKO, SHAPE, and USACAPOC. This includes interagency operational lines of coordination and protocols, as well as training programs of instruction.
- Doctrinal guidelines and operational lines of coordination for integration of CMO are needed in the following areas:
 - Security and intelligence operations;
 - Information and influence operations; and
 - Political-military coordination and operational analysis.
- Most importantly, CA/CIMIC officers and NCOs need to be better qualified, trained, and selected for operational CMO. KFOR CIMIC liaison officers, for example, needed to be active enablers. Likewise, staff with CMO-related missions need to continue to improve CMO knowledge.
- Civil-military and interdisciplinary coordinating mechanisms at the theater level should be strengthened. Information-sharing

technologies should be incorporated into a comprehensive and phased civil-military coordination architecture, which includes a CMO, CJCMTF, and HCIC.

- A CMO campaign plan should be used and revised through all phases. Troop-to-task analyses help identify CA/CIMIC needs to give force providers time to find the right personnel.
- The CIMIC report needs to evolve as a key tool to enabling civil-military and interstaff unity of effort. To improve reporting synchronization and soft information transparency, a reports Web site should be considered.
- NATO and the U.N. should consider a joint lessons-learning regime using current resources (CIMIC Center, JOC, SITCEN). An operational lessons Web site could cast the net wide for live-lesson learning as well as improve staff transition in both communities.
- Advanced interdisciplinary CMO/PSO training should be instituted.
- SHAPE needs to develop doctrine outlining the roles, responsibilities, and background requirements for operational-level CIMIC NCOs, as well as develop an appropriate NATO CIMIC Course POI for CIMIC NCOs.
- In order to manage levels of expectation, deploying CA/CIMIC personnel should be briefed in advance on the CMO situation, etc., when possible by experienced CA/CIMIC personnel. A CMO/PSO Web site may also help.

¹A February 2001 update of the database counted 900 NGOs in Kosovo. However, about 40 percent are local or regional, a ration much higher than previously estimated. As the international presence following the November 2001 elections began to diminish, the ratio of local NGOs climbed over 50 percent.

²CIMIC (civil-military cooperation) is the U.N. and NATO term for much of what U.S. Civil Affairs (CA) doctrine calls civil-military operations (CMO). The U.N. uses *civil affairs* for its civil administration. The more comprehensive term, CMO, is used here to describe the general activities that a military force conducts in coordination with and in support of civilian entities in a peace

support operations environment. CIMIC and CA are used as they apply specifically to NATO or U.S. entities, personnel, or activities.

³*Democracy by Force—U.S. Military Intervention in the Post-Cold War World*, Karin von Hippel, Cambridge University Press, Cambridge: 2000.

⁴United States Institute for Peace, *Taking it to the Next Level: Civil-Military Cooperation in Complex Emergencies*, 31 August 2000, p. 20.

⁵See *Starting from Scratch in Kosovo: The Honeymoon Is Over* published by the International Crisis Group, 10 December 1999.

⁶For a detailed discussion of developments in UNMIK during this time, see the *United Nations Security Council Report of the Secretary General on the United Nations Interim Administration Mission in Kosovo*, Reports S/2001/218 of 13 March 2001, S/2001/565 of 7 June 2001, and S/2001/926 of 2 October 2001, which the author drafted as Political Affairs Reporting Officer at UNMIK.

⁷U.N. Security Council Report S/2000/809, *Report of the Panel on United Nations Peace Operations*, 21 August 2000. See especially pp. 34-37 and 42-44.

⁸Based on written notes received from Col. Dzeidzic in November 2000.

⁹The many successes of both KFOR and UNMIK are well documented and updated in their respective Web sites, www.kforonline.com and www.un.org/kosovo. See especially the Reports of the Secretary General to the Security Council via the U.N.'s home page, www.un.org/documents.

¹⁰NATO CIMIC Doctrine [Provisional Final Draft], SHAPE AJP-9, Chapter 1, p. 1-2.

¹¹"NATO Patrols Edgy border, This Time Protecting Serbs", Michael R. Gordon, *New York Times*, 25 January 2001, nytimes.com.

¹²See "Troops Say Kosovo Duty Sharpens Their Skills," Michael R. Gordon and Steven Erlanger, *New York Times*, 18 January 2001, www.nytimes.com, as well as "U.S. Troops in the Balkans Defend Role," Tom Hundley, *Chicago Tribune*, 4 February 2001, www.chicago.tribune.com

¹³"Infantry Chief: Cultural Intel Must Improve," Sean Naylor, *Army Times*, 20 November 2000, p. 15.

¹⁴U.N. Security Council Report S/2000/809, *Report of the Panel on United Nations Peace Operations*, 21 August 2000, p. 39.

Christopher Holshek, Lt. Col., U.S. Army Civil Affairs, was deployed from the 304th Civil Affairs Brigade, Philadelphia, PA, to HQ KFOR (J9) February-October 2000 and served as a KFOR CIMIC Liaison Officer to UNMIK Civil Administration (Pillar II) and the Office of the Special Representative of the Secretary General (O/SRSG). Prior to that, he has had extensive experience in the planning and deployment of U.S. Army Civil Affairs forces to the Balkans. He has also served with the United Nations in a civilian capacity as a Logistics Officer during all phases of the U.N. Transitional Administration in Eastern Slavonia (UNTAES) mission in Croatia. The Brigade Civil Information Officer, he returned to Kosovo in December 2000 as a civilian to serve with UNMIK as a Political Affairs Reporting Officer at the O/SRSG. He has since returned to the U.S. and has taken command of the 402nd Civil Affairs Battalion near Buffalo, NY. The opinions expressed in this chapter are entirely his own and do not, except when specifically indicated, reflect official U.N., NATO, or U.S. Army opinion. Comments and questions can be sent to: holshek@cswebmail.com

CHAPTER XIV

Shaping the Environment for Future Operations: Experiences with Information Operations in Kosovo

Steven M. Seybert

Introduction

This chapter presents how information operations were conducted by the Multinational Brigade-East, or MNB(E), of NATO's Kosovo Force (KFOR) from April through July 2000.¹ Abiding by the U.S. joint service concept of information operations as an integrating strategy,² information operations in MNB(E)'s sector of responsibility was an effort to integrate the activities of various commanders, staff elements, and soldiers from the MNB(E) headquarters and subordinate multinational battalion task forces to achieve synergistic effects through targeting and protecting: information, the infrastructure used to transfer information, the decisionmakers that used information, and the information gathering and processing functions supporting those decisionmakers.

Standard U.S. Army planning and targeting processes were used to integrate information operations into MNB(E) operations. Targeting, which is often considered only for its lethal aspects, was applied solely through the frequently overlooked nonlethal means. Likewise, information operations is often thought of in technical terms of protecting and attacking computers and networks, but in Kosovo the focus of its application was less technical. Although the integrity and protection of automated information systems was certainly emphasized in Kosovo, the primary focus for information operations was providing and protecting factual information to influence key decisionmakers and the populace. Even though information operations were conducted in a less technical manner, its application was still complex. This chapter attempts to explain

the complexities of that less technical, nonlethal application of information operations in support of peace operations in Kosovo.

Other nations and forces lag in the integration of information technology into military operations compared to the U.S. and its armed forces. Given that lag and the continuing global role of the U.S. armed forces in peace operations, the application of information operations in Kosovo may be indicative of its use in future U.S. Army operations.

The Nature of Information Operations in Kosovo

The MNB(E) conducted maneuver, civil-military, and information operations to accomplish their mission of maintaining a safe and secure environment in the brigade's sector of responsibility. The MNB(E) information operations section planned and executed information operations to influence key decisionmakers and members of the local population to behave in manners that supported MNB(E) operations to maintain that safety and security. By U.S. military doctrine, information operations are actions taken to affect adversary information and information systems while defending one's own information and information systems.³ In simple terms, information operations are military operations conducted in the information environment. The ultimate objective of information operations conducted in support of tactical Army operations is to attain and sustain information superiority for the commander. In the context of MNB(E)'s mission this meant gaining information superiority by affecting the flow and content of information to key leaders and population groups within the area of operations. In support of MNB(E)'s peacekeeping mission, information operations was primarily focused on shaping the attitudes and behaviors of the local Kosovar leaders and population by disseminating factual information with related messages.

Rather than attempting to conduct an effort at perception management, the MNB(E) information operations effort focused on providing operationally relevant information to leaders and the population.⁴ Facts on topics, issues or incidents relevant to MNB(E)'s mission were provided along with the brigade's interpretation of those facts. At times, MNB(E) demands based upon the facts were also provided. The intent was to cause the leaders or population members receiving the information to modify their attitudes and behaviors based on their acceptance of the facts and an understanding and acceptance of

MNB(E)'s interpretation or demands. MNB(E)'s interpretation of the facts and any associated demands constituted messages that were presented to the local Kosovar leaders and the populace along with the pertinent facts.



Figure 1. An MNB(E) Leader Delivers a Message to a Kosovar Serbian Village Leader

The messages provided to local leaders and population groups were intended to cause a motivational dilemma in an attempt to achieve desired attitudes and behaviors to support accomplishment of the MNB(E) mission. To develop these messages, the information operations section worked with the G2 in analyzing the target audiences' existing attitudes and motivations to identify critical vulnerabilities that could be used to influence these audiences. For audiences that wanted to legitimately participate in the civil structures being established by the United Nations Interim Mission in Kosovo (UNMIK) and supported by KFOR, this was relatively simple. A political party leader that wanted to gain stature by participating on the UNMIK Municipal Council or Administrative Board needed to cooperate with UNMIK and KFOR to some extent in order to achieve their political goal. However, finding accessible vulnerabilities to influence was much more difficult for the target audiences that either operated in between the

legitimate structure and illicit activities or who only desired to operate in the underground, illicit aspects of Kosovo society. For these target audiences, often only negative reactions could be offered. That is, the targeted individual could be threatened with lawful actions, such as detention, or a population group could be threatened with the loss of the international community's or MNB(E)'s support in the form of humanitarian assistance or civil projects.

The dissemination of factual information was critical to maintaining the credibility of KFOR and consequently the effectiveness of information operations. MNB(E)'s credibility, based on impartiality, was vital in order for the local leaders and populace to accept the information and messages that the brigade's leaders and soldiers presented. Thus, MNB(E) had to put effort into maintaining its credibility. Emphasis was also placed on the MNB(E) keeping "the moral high ground" to ensure credibility was maintained. The continued strong support of the ethnic Albanian populace demonstrates this credibility maintenance. Ethnic Albanian support for NATO, KFOR, and the U.S. forces in Kosovo continued throughout KFOR's deployment despite alleged and proven mistreatment of Kosovar Albanians by U.S. forces, such as the case of SSG Frank Ronghi who murdered an ethnic Albanian girl during the first USKFOR rotation in Kosovo. Although developments in the Ronghi case continued throughout the deployment and local media continued to periodically inquire about its status, the majority of the population showed no concern for the case. Maintaining the moral high ground and consequential credibility meant that the MNB(E) had a responsibility to inform the local populace and leaders of current developments in the Ronghi case. Nevertheless, presenting the information as it became available also allowed the MNB(E) valuable opportunities to demonstrate their credibility and their acceptance of moral responsibility. Also, serious accidents for which MNB(E) was responsible that resulted in injuries and fatalities to Kosovar Albanians did not noticeably abate the support of the local populace. One such accident was the shooting death of a 6-year-old ethnic Albanian boy, Gentrit Rexhepi, by an U.S. soldier in July 2000. The continued ethnic Albanian support was all the more astounding given that these incidents came on the heels of reported fatalities and injuries to Kosovar Albanians caused by NATO air strikes during Operation Allied Force.⁵ MNB(E)'s efforts to maintain credibility and impartiality were intended to ensure that the local populace would accept the brigade's facts and explanations surrounding

events such as the Ronghi case and the Rexhepi shooting to keep the people's continued support.

The brigade conducted information operations to shape, modify, and reinforce local attitudes and behaviors. In using information operations for shaping purposes, the intent was to provide information, messages, and demands surrounding topics or issues relevant to maintaining a safe and secure environment to achieve attitudes and behavior that would preempt inappropriate future actions. For example, both Albanian and Serbian Kosovars observed various religious and historical holidays. Many of these holidays were specific to a town or municipality, such as the observance of a Serbian Orthodox patron saint's feast day or a memorial day for a fallen local Kosovo Liberation Army (KLA) hero. Information on appropriate conduct during local holiday celebrations was disseminated to specific local leaders and local populations to remind them of the need for safe, peaceful behavior and respect for other cultures and ethnicities in the local area during their celebrations.

Information operations to modify attitudes or behaviors were essentially reactive operations conducted as a result of an incident or observed trends in incidents that MNB(E) responded to during current operations. For example, a civil disturbance in the town of Sevice during April 2000 during which MNB(E) personnel and Serbs were injured had not been anticipated. In response to the incident, MNB(E) leaders, civil affairs (CA), and psychological operations (PSYOP) personnel delivered messages to local Serb leaders and the populace to quell the existing tension. Subsequent to the conflict resolution, information and associated messages and demands were disseminated with the intent of preventing future confrontations or diminishing the related violence.



Figure 2. An Injured MNB(E) Soldier Is Assisted by a Fellow American and a Polish Ally During a Civil Disturbance in the Town of Sevice, Kosovo

The brigade worked to reinforce the attitudes and behaviors of the many residents of Kosovo who acted peaceably and willingly complied with UNMIK and KFOR directives. Information operations were conducted to ensure their continued support and project the effects of cooperation with KFOR and UNMIK and ethnic tolerance within communities. MNB(E) attempted to focus civil-military projects and humanitarian assistance to these cooperative communities. More importantly, information operations focused on projecting to other population groups in sector the effects of residents and communities that benefited from practicing cooperation and tolerance. Information on the benefits that these communities were receiving was disseminated throughout the sector along with messages urging other Kosovo residents to behave accordingly so that they and their communities could similarly benefit. MNB(E) cancelled or postponed civil-military projects and withdrew humanitarian assistance from communities where ethnic intolerance or violence continued or experienced an outbreak. These same actions were taken against communities that demonstrated trends or specific instances of noncooperation with KFOR and UNMIK.

Defensively, information operations were applied in MNB(E) in two aspects: operations security (OPSEC), and preempting and countering misinformation and propaganda. OPSEC policies and procedures were established and their implementation overseen at MNB(E) headquarters. Misinformation and propaganda were continuously monitored through

media analysis, intelligence reports, and unit and staff operations reports. Propaganda was also anticipated in the brigade's operations planning. Based on the reporting, analysis, and planning then, facts and messages were disseminated to appropriate audiences to either preempt or indirectly counter the false information. Direct refutation of false information, especially of propaganda, was avoided. Direct refutation only lent the propaganda credibility and risked potential loss of the moral high ground if the brigade became embroiled in a tit-for-tat information exchange with less credible sources.

Propaganda and misinformation was sporadic but challenging. The general trend was that once one subject died down, another would be perpetuated. Some topics were recurring, dying down at one point only to be rejuvenated at a later time. Misinformation and propaganda flowed in sector from various sources, including from media sources within Kosovo, Serbia, and Albania. Word of mouth from travelers throughout the region and sector also constituted a large source of misinformation and disinformation. Propaganda in Kosovo tended to be very simplistic and obviously contrived. Serbian propaganda lacked credibility with the local population, especially ethnic Albanians. Nevertheless, Kosovar Serbs apparently felt compelled to believe their government's stories out of pure nationalism or refused to accept MNB(E)'s version of information out of spite rather than actually be convinced of their government's propaganda. Albanians also seemed to feel a nationalistic duty to subscribe to the opinions presented in ethnic media. Therefore, MNB(E) had to honor the challenge that propaganda and misinformation posed, respecting them as potential threats to the mission, and working to counter their effects.

Organization

The brigade's information operations section consisted of four personnel during USKFOR rotation 1B under the 2nd Brigade, 1st Infantry Division, and five personnel under the 1st Brigade, 1st Armored Division, during rotation 2A. The information operations section included a Field Support Team (FST) from the U.S. Army's Land Information Warfare Activity (LIWA) that supported the MNB(E) Commander in conducting information operations as part of Operation Joint Guardian. The FST operated as an integral part of the MNB(E) staff. LIWA FSTs traditionally augment U.S. Army commands with

information operations expertise to support the planning and conduct of information operations. Teams consist of a mixture of information operations-related specialists.⁶ Although normally intended to fill the gaps in the supported command's information operations staff, LIWA FSTs have found themselves increasingly taking on the full information operations role of the staff with little to no investment from the supported command. The LIWA FST served as the core of the MNB(E) information operations section. The LIWA FST Chief, a U.S. Army Major, also acted as the MNB(E) information operations officer during rotation 1B. The 1st Armored Division Deputy Fire Support Coordinator (DFSCOORD), a U.S. Army lieutenant colonel, acted as the MNB(E) information operations officer under rotation 2A. The MNB(E) information operations officer was the primary staff proponent for all the brigade's information operations activities. Other members of the information operations section were all LIWA FST members and consisted of a captain who functioned as the information operations planner, a sergeant first class who was the FST and section NCOIC, and a civilian contractor who performed as the section's targeting officer. The information operations section was assigned to the MNB(E) G3 and physically resided in the G3 Plans section of the MNB(E) headquarters at Camp Bondsteel. Their primary functions were planning, targeting, monitoring information operations execution, and information operations assessment.

The FST's staff relationship with MNB(E) varied with the supported command. That is, the relationship was different during the 1st Infantry Division rotation from the 1st Armored Division rotation. During rotation 1A under the 1st Infantry Division, the LIWA FST Chief acted as the MNB(E) information operations officer. No personnel from 1st Infantry Division filled a specific information operations role; the LIWA FST assumed the full authority for the brigade's information operations mission. When the 1st Armored Division assumed the mission as the USKFOR and command of the MNB(E), however, the Division invested their indigenous personnel in performing the information operations staff mission. The DFSCOORD was appointed as the MNB(E) information operations officer. Also, Battalion Fire Support Officers (FSOs) were appointed as information operations officers in the subordinate battalions of the 1st Brigade, 1st Armored Division, to plan and oversee execution of information operations in their commanders' sectors of responsibility. All the other multinational battalion task forces appointed various staff officers to act as their

staff information operations officers. This provided a technical chain in addition to the chain of command to ensure information operations tasks and responsibilities were carried out.

The use of unit fire support personnel as the primary staff for information operations was appropriate since no active fire support missions were conducted in Kosovo other than firing nighttime illumination missions to support search and reconnaissance operations and as a deterrent to suspected smuggling operations. Supported unit investment in the information operations mission is critical if only from a resourcing standpoint. Nevertheless, it also demonstrates and facilitates unit ownership of and commitment to conducting information operations. From the LIWA FST's perspective, when a unit invests its own personnel to perform the information operations staff mission, then the LIWA FST does not have the task of advocating information operations to the unit as outsiders. Since some units view information operations as a new, unique requirement competing for limited operational resources, attempting to champion information operations as an outsider is an unenviable task.

Using fire support personnel as battalion task force information operations staff officers was effective because of the relationship between information operations and the Army's standard targeting process. The Army's standard targeting process is used to integrate lethal and nonlethal fires into a single concept of fire support for any given military operation. For peace operations such as Kosovo, lethal fires may be planned, but usually their execution is inappropriate or may not be required. Thus, nonlethal fires are generally the only ones that are executed. The nonlethal fires or engagements conducted in Kosovo, as they have been in Bosnia, were principally verbal and symbolic messages. Face-to-face discussions, town meetings, search operations, temporary detention, patrols, and artillery illumination round firings that illuminated an area without any ground explosion are all examples of nonlethal fires used in Kosovo to send messages to specific targeted audiences. The same targeting process used for combat operations was used in Kosovo, although modified to accommodate the focus on only nonlethal engagements. U.S. Army fire support personnel are trained on the targeting process and are generally familiar and experienced with its application. Therefore, appointment of fire support personnel as unit information operations officers was an

effective method for ensuring a capability at subordinate battalion level to plan, execute, and assess information operations.

The information operations section's responsibilities included conducting coordination internal and external to MNB(E) and included both operational and administrative activities. The section was responsible for coordinating the brigade's information operations activities with the KFOR information operations section, the MNB(E) staff, subordinate multinational battalions, specific members of the international community and U.S. government in Kosovo, and the LIWA. The information operations section planned and facilitated the conduct of the MNB(E) Information Operations Working Group (IOWG), which conducted weekly meetings to coordinate sector-wide information operations activities and assessments. The section was also responsible for developing information operations plans, providing input to MNB(E) operations plans and orders, and maintaining and updating the information operations portions of existing MNB(E) contingency plans. The section developed information operations intelligence requirements and coordinated them with the G2's Analysis and Control Element (ACE). The information operations section also coordinated the development of information operations-related intelligence and assessment products with the ACE, to include an on-going intelligence preparation of the sector's information environment that the information operations targeting officer maintained. The section extracted and compiled information operations-related information from various internal and external sources and disseminated this information daily to the MNB(E) staff. These information efforts included monitoring and advising on propaganda issues and developments, weekly media analysis, as well as the receipt and integration of information operations-focused information from the LIWA. Finally, the information operations section was responsible for the planning, execution, and assessment of the MNB(E) information operations targeting effort.

Processes

Information operations were integrated into MNB(E) maneuver and civil-military operations through the U.S. Army military decisionmaking process (MDMP) and a modified Army targeting process to integrate nonlethal engagements into a cohesive, focused information operation.

The brigade's information operations, as with other MNB(E) operations, was centrally planned with decentralized execution.

The Multinational Brigade-East used the MDMP to plan brigade operations. The MDMP is a single, standard process for U.S. Army units to plan well-integrated, coordinated, and synchronized military operations.⁷ Using planning techniques to integrate information operations into the MDMP that were developed by LIWA FSTs during previous Bosnia rotations and various military exercises, information operations planning was integrated into the MDMP for brigade operations and thereby planned as an integral part of the overall operation and not as a separate or parallel operation. The Planner from the information operations section acted as a core member of the G3 staff planning group and produced information operations input and annexes to brigade operations plans (OPLANs), operations orders (OPORDs), and fragmentary orders (FRAGOs). These information operations inputs and annexes were written and formatted in accordance with U.S. Army FM 101-5, *Staff Organization and Operations*,⁸ to conform to the formats used by the G3 staff planning group for the brigade's plans and orders.

The Army's targeting process is known as the decide, detect, deliver, and assess (D3A) process. The D3A process as described in the U.S. Army FM 6-20-10, *Tactics, Techniques, and Procedures for the Targeting Process*, is used during combat operations to direct both lethal and nonlethal engagements to achieve specified effects. The MNB(E) used a modified D3A targeting process integrated into the brigade's battle rhythm to plan and execute only nonlethal engagements against key decisionmakers and population groups in sector. Some of the methods and means used to conduct nonlethal engagements included: face-to-face meetings by commanders and staff officers with key local leaders; patrols and checkpoints conducted by maneuver forces; radio broadcasts; press releases; posters, fliers, and other printed products; and press interviews. The modified targeting process was used to plan effects for shaping the environment for future MNB(E) operations as well as supporting the brigade's information operations. The targeting process integrated targeting, intelligence collection, and information operations into a cohesive effort to focus nonlethal methods and means on achieving effects that shaped attitudes, behaviors, and events in sector to support MNB(E) future operations.

The MNB(E) targeting process was conducted during a 1-week cycle. The cycle began on Monday with the development of an initial concept of engagements and culminated on Sunday with the publication of the weekly targeting FRAGO. The weekly targeting FRAGO directed nonlethal engagements, leveraging information from medical/dental civilian assistance program (MEDCAP/DENCAP) events and civil-military operations (CMO), and the subordinate battalion task forces' supporting information operations actions and activities. These events, operations, actions, and activities were planned for a 1-week period 2 weeks in advance of when they would be executed. Targeting tasks were adjusted the week prior to execution to accommodate changes in the sector's situation. The MNB(E) commander received a weekly decision briefing during which he approved the concept of engagements and provided targeting guidance to initiate planning for the subsequent week.

The intelligence preparation of the information environment maintained by the information operations section served as a basis for information operations planning and targeting. The purpose of the intelligence preparation was to define the information environment in MNB(E)'s sector, analyze how others might use it to oppose the MNB(E) mission, and estimate how it might impact on the brigade's operations. This intelligence preparation was based on the procedures prescribed in the U.S. Army FM 34-130, *Intelligence Preparation of the Battlefield*. The intelligence preparation focused on identifying and analyzing the capabilities and vulnerabilities of the information infrastructure and key local leaders and decisionmakers and their related information gathering and processing. Key leaders and decisionmakers were analyzed to identify critical persons to engage in the MNB(E) nonlethal targeting effort. The intelligence preparation also included a detailed examination of the information infrastructure in an analysis of the use and flow of information to social, civil, political, media, paramilitary organizations, and key personnel in the sector. Analysis of the information gathering and processing focused on how the Albanian and Serbian Kosovar political and societal systems collected, disseminated, and used information. The gathering and processing analysis also considered the local leaders' and populace's methods for accessing and using information along with their decisionmaking and execution processes. The information infrastructure and the information gathering and processing methodologies were analyzed to identify information conduits for engaging targeted leaders and decisionmakers, including the local residents. Additionally, the information operations

section used the intelligence preparation of the information environment to help estimate how the local leaders and populace might use the information infrastructure during future operations. The information operations section then considered how to prevent the leaders' and populace's use of the information infrastructure from adversely affecting the MNB(E) mission and how to capitalize on opportunities that use might present for advancing the mission.

The information operations section tracked key events and activities on a daily basis through the MNB(E) G3 Battle Captain and Current Operations section to identify any event or activity that may have required information operations to respond to by modifying or reinforcing attitudes or behaviors. If unanticipated information operations-related events occurred, then the Battle Captain initiated coordination with the information operations section or with PSYOP, CA, and public affairs (PA) representatives as appropriate to respond to the situation. The information operations section ensured that key brigade personnel were advised and updated through either the normal staff battle rhythm and the targeting cycle or through direct staff coordination with the MNB(E) G3 or the chief of staff.

The G3 activated the MNB(E) Crisis Action Cell (CAC) for significant unforeseen, operational matters that could adversely affect the MNB(E) mission. The CAC consisted of key members of the MNB(E) battle staff, including a representative from the information operations section—usually either the information operations planner or the information operations officer. The CAC synchronized and coordinated the brigade's planned reaction to the event and then issued a FRAGO tasking the appropriate units to execute the planned operation. While an information operations section representative attended the CAC, other members of the section supported if necessary by initiating development of required products.

Planning, Executing, Targeting, and Assessing Information Operations

The information operations section participated in and chaired various meetings with the MNB(E) command and staff and the KFOR information operations section to facilitate accomplishment of their functions of planning and conducting information operations, to include planning,

executing, and assessing the brigade's information operations targeting. The accomplishment of these functions and conduct of the various meetings comprised the information operations section's "battle rhythm," which was synchronized with the MNB(E)'s command and staff battle rhythm. (See Figure 3.) The information operations section's battle rhythm was structured on the development of various products to support information operations planning, execution, and assessment throughout the week. Key meetings that the information operations section participated in and chaired supported the section's development of the information operations products. These meetings were the Initial Targeting Meeting, the Target Coordination Meeting, the IOWG, the MNB(E) Assessment Meeting, the KFOR IOWG, the Executive Targeting Meeting, and the Commander's Decision Briefing.

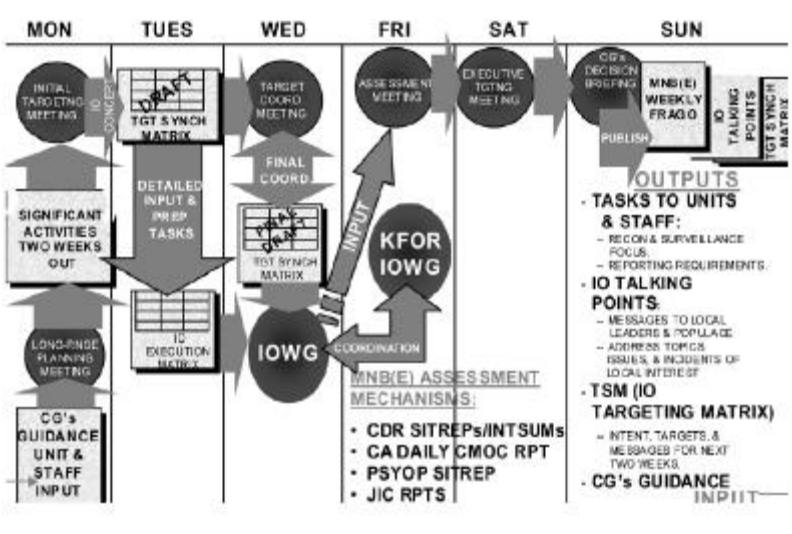

Figure 3. MNB(E) Information Operations Battle Rhythm

The MNB(E) Fire Support Element (FSE) chaired the Initial Targeting Meeting each Monday with the FSE targeting officer acting as the lead. This meeting initiated the weekly targeting cycle by building a concept of engagements for the target planning week, which was 3 weeks out. During the meeting, the expected situation in sector was analyzed and desired operational results were established. Information operations targeting objectives, potential targets, and possible viable concepts for messages and delivery means were identified during the meeting.

The Target Coordination Meeting was led by the G3 or the Deputy G3 and chaired by the chief of staff. The meeting was held to further refine the objectives, targets, and concepts developed during the Initial Targeting Meeting. The Target Coordination Meeting provided the chief of staff and G3 the opportunity to make any required mid-course adjustments to the operations being planned. At the coordination meeting, specific tasks and purposes were reviewed to ensure focus for the MNB(E) operations during the target planning week.

The Executive Targeting Meeting chaired by the chief of staff allowed the review of the planned intelligence and maneuver operations, information operations concepts, and associated information operations targeting efforts with the brigade's primary staff officers prior to the commander's Targeting Decision Briefing. The information operations section made final refinements to materials for presentation at the Decision Briefing as a result of guidance and directed adjustments from the chief of staff.

The commander's Decision Briefing was the forum for receiving the MNB(E) commander's approval of the operations and information operations targeting planned to begin within 2 weeks. The briefing also provided the commander a final review of the following week's operations and targeting effort prior to execution. Additionally, the briefing allowed the commander an opportunity to provide his guidance to initiate planning and targeting starting with the next day's initial targeting meeting, thereby starting the next planning and targeting cycle. The meeting's agenda included an assessment of the intelligence, maneuver, and information operations for the previous week; a review of the current week's planned intelligence, maneuver, and information operations; and the concept for intelligence, maneuver, and information operations for the target planning week.

The information operations section monitored the execution of information operations by MNB(E)-level assets and the subordinate battalion task forces primarily through the weekly IOWG meeting. The IOWG served as a forum to exchange information among representatives of the primary staff elements and units involved with conducting the brigade's information operations. The purpose of the information exchange was to facilitate coordination and synchronization of information operations in sector for the upcoming week and to obtain evidence to support accurate assessments of key trends and critical

events indicating the success or failure of the brigade's information operations. Attendees included the maneuver battalion information operations representatives and representatives from the G2, G3, the staff Surgeon's Office, Combat Camera, the Public Affairs Officer (PAO), G5/CA, PSYOP, and the Special Operations Coordination and Control Element (SOCCE). A weekly meeting to coordinate and assess information operations was sufficient since more time could be taken in tracking and assessing operations and generally there was no need for minute-to-minute scrutinizing of operations during execution because the tempo of operations for MNB(E) while conducting peacekeeping was generally slower than may have been expected in combat. In the IOWG, the subordinate battalions and MNB(E) assets addressed the status of directed tasks and discussed their contributions to the brigade's information operations. Multinational battalion task force representatives provided verbal reports on their assessments for the previous week's information operations activities in their units' sectors and cited trends or key events as evidence of progress in meeting the targeting objectives.

The daily commander's Update Briefing and the Weekly Extended Update Briefing also facilitated the monitoring of information operations execution. At these briefings, subordinate battalion task force commanders addressed events that occurred in their respective sectors and upcoming operations, which at times included information operations-related actions or activities.

The information operations section assessed the status of the information operation by analyzing key events and trends within the sector in comparison to the targeting objectives that were established and reviewed from week to week. All MNB(E) intelligence and operations reports, including commander's situation reports (SITREPs), were reviewed for indications as to whether the objectives were being attained. Multinational battalion task force representatives provided written assessment reports by Friday each week. Information from the assessment sources was compared from one week to the next to ascertain trends in sector. Anecdotal evidence gathered from incidents and activities was reviewed for indications of change in the information operations situation in sector and indications of success or failure of the information operations effort. The information operations section assessed the anecdotal evidence in conjunction with awareness of the sector's current situation, including

the political, cultural, and informational aspects, to determine the status of attaining the targeting objectives.

The G3 chaired the weekly assessment meeting to assess the effectiveness of the brigade's intelligence, maneuver, and information operations conducted during the previous week. Attendees included the G2 collection manager, the FSE targeting officer, the information operations targeting officer, the medical planner from the staff Surgeon's Office, and representatives from PSYOP and SOCCE. Effectiveness was determined by analyzing relevant information and intelligence gleaned from intelligence and operations reports from throughout the brigade. This information was applied against measures of effectiveness for directed engagements to determine whether the desired effects were achieved and against current targeting objectives to determine the progress towards their attainment.

The information operations section conducted a weekly analysis of local, regional, and international media, including newspapers and periodicals published in Kosovo as well as Serbia, Macedonia, and Albania to determine potential impact on achieving the MNB(E) mission. The information operations section's analysis of the media relied on the Daily Falcon produced by the G2's Open-Source Intelligence (OSINT) section and media analysis products of international and regional media that were produced by the LIWA at Fort Belvoir, Virginia. The analysis focused on media reporting of events in MNB(E) sector and also of MNB(E) units and their activities. The media analysis was conducted to identify issues of potential importance to the sector's populace and possible propaganda or misinformation directed against the populace or the MNB(E). A summary of the information operations section's media analysis identifying the main topics and themes culled from the press and their potential impact on the brigade's mission was presented during the MNB(E) commander's Decision Briefing each week.

The KFOR information officer chaired the weekly KFOR IOWG meeting attended by information operations representatives from each MNB. During the meeting, each MNB reviewed the focus of their information operations for the previous and upcoming weeks. This allowed for coordination of information operations efforts among the MNBs and receipt and coordination of any KFOR information operations tasks. The KFOR IOWG meeting also served as a forum for the MNBs to voice issues and exchange information operations techniques and procedures.

However, KFOR and other MNBs did not conduct information operations as MNB(E) did since MNB(E)'s information operations were based on U.S. doctrine, tactics, techniques, and procedures.

The MNB(E) information operations section produced several products throughout the weekly battle rhythm that facilitated the planning and execution of information operations during the subsequent weeks. These products included the Target Synchronization Matrix (TSM), the information operations Execution Matrix, information operations talking points, and the information operations Read File.

The TSM directed nonlethal engagements of specific key leaders and populace groups in the Brigade sector. (See Figure 4.) Each matrix covered a 1-week period and was used to synchronize information operations engagements by MNB(E) headquarters assets and subordinate multinational battalion task forces. The concept for the information operations engagements reflected on the TSM was approved by the MNB(E) commander at the Decision Briefing 1 week in advance of the planned targeting week. Upon the commander's approval, the TSM was issued via FRAGO. The TSM was the key input to the information operations Execution Matrix.

The information operations Execution Matrix focused and coordinated directed information operations activities from the MNB(E) headquarters to headquarters-level assets and subordinate multinational battalion task forces over a 1-week period (see Figure 5). It was issued in a FRAGO the week prior to its required execution. The Execution Matrix assigned tasks to each of the headquarters assets and subordinate battalions with an explanatory purpose provided for each task. Providing the purpose for the task ensured that the tasked execution authority not only understood what was to be done, but why it was required. The matrix also identified key events and dates occurring in sector during that week. These events and dates provided notice of potential activities that could adversely affect the brigade's mission and potential opportunities that could be capitalized on to advance the mission. The events and dates included religious and cultural holidays as well as local planned events that could lead to violent or unsafe activities, especially those events that had the potential to result in friction between ethnic groups. Many of the events also provided the opportunity to access key local leaders and populace groups who would be in attendance. The information operations section maintained a database of the key dates and an assessment of activities that occurred to support future planning and product development.

IO Target Synchronization Matrix (Week XX: DD JUNE 00 – DD JUNE 00)

TARGETING OBJECTIVES: 1. Reduce popular support to extremist elements. 2. Prevent interference with KFOR/UNMIK efforts. 3. Increase inter-ethnic cooperation.						
DECIDE		DETECT & DELIVER				ASSESS
TGT SET	TARGETS	ASSET	HOW	WHEN	EFFECTS	ENDSTATE/MEASURES OF EFFECTIVENESS
GROUP X POLITICAL LEADERS	REGIONAL LEADER, PARTY A	POLAD	Message Numbers W - X	NLT DD JUN	WARN	PURPOSE: Withdraw support for violent demonstrations. ASSESSMENT: Response to messages.
	PROVINCE LEADER, PARTY B	BDE CDR	Message Numbers Y - Z	NLT DD JUN	INFLUENCE	PURPOSE: Gain agreement to speak out against violent demonstrations. ASSESSMENT: Response to messages.
	MUNICIPAL LEADER, PARTY C	TF XX IN	Message Numbers W - X	NLT DD JUN	WARN	PURPOSE: Withdraw support for violent demonstrations. ASSESSMENT: Response to messages.
GROUP X CIVIL LEADERS	MUNICIPAL COUNCIL REP	TF XX IN	Message Numbers Y - Z	NLT DD JUN	INFLUENCE	PURPOSE: Gain agreement to speak out against violent demonstrations. ASSESSMENT: Response to messages.
	MAYOR, CITY A	TF XX AR	Message Numbers Y - Z	NLT DD JUN	INFLUENCE	PURPOSE: Gain agreement to speak out against violent demonstrations. ASSESSMENT: Response to messages.
	POLICE CHIEF, CITY A	TF XX AR, TFP Provost Marshal	Message Numbers U - V	NLT DD JUN	CO-OPT	PURPOSE: Gain support in preventing violent demonstrations. ASSESSMENT: Response to messages.
GROUP X POPULACE	POPULACE CITY A	TF XX AR MEDICAL CO PSYOP CO	Message Numbers S - T	During MEDCAP DD JUN	INFLUENCE	PURPOSE: Prevent violent demonstrations. ASSESSMENT: Response to messages.
	POPULACE CITY B	TF XX IN, G5/CA BN, PSYOP CO	Message Numbers Q - R	During CMO DD JUN	INFORM	PURPOSE: Project effects of efforts to prevent violence in City A. ASSESSMENT: Response to messages.
NOTE: Associated messages on attached pages. EFFECTS: CO-OPT – Gain cooperation. DESTROY/DENY – Render ineffective by physically destroying or denying (i.e. confiscate equipment, detain personnel, occupy facility or terrain). INFLUENCE – Cause a specific action or behavior. INFORM – Provide information (to counter misinformation or propaganda). WARN – Provide notice of intent (to prevent a specific action).						

Figure 4. Target Synchronization Matrix

IO EXECUTION MATRIX (DD – DD MM YY)

SIGNIFICANT DATES & EVENTS	Armed Forces Day – Serbia	KLA War Memorial Commemoration – Municipality A	Market Day – Town A	K-Serb Patron Saint Religious Observance – Town B	Market Day – Town C	Serb Mayors' Meeting – Municipality B	Albanian Mayors' Meeting – Municipality C
MNB(E) ASSETS AND UNITS	MONDAY DD MM YY	TUESDAY DD MM YY	WEDNESDAY DD MM YY	THURSDAY DD MM YY	FRIDAY DD MM YY	SATURDAY DD MM YY	SUNDAY DD MM YY
Brigade Commander	Task: Engage sector key political leader. Purpose: Warn to not promote violence in Municipality A.						
PSYOP	Task: Engage populace in Municipality A. Purpose: Influence to conduct peaceful commemoration.		Task: Engage K-Alb populace vicinity Town B. Purpose: Influence to not interfere with religious observance.				
PA	Task: Capture information from CMC project in Town D, Municipality A. Purpose: Incorporate info in sector-wide products.				Task: Escort media to Town C market day. Purpose: Capitalize on media opportunity to demonstrate inter-ethnic cooperation at market		
Combat Camera	Task: Capture information from CMC project in Town D, Municipality A. Purpose: Incorporate info into sector-wide products.		Task: Capture information from combined MECAP/ DENCAP to Town B. Purpose: Incorporate info into sector-wide products.				

OSCA	Task: Engage community leaders in Town D during CMO project. Purpose: Warn to not promote violence.		Task: Engage K-Alb populace vicinity Town B during HA visit. Purpose: Influence to not interfere with religious observance				
TF X-XX (US) Infantry			Task: Engage K-Alb and K-Serb leaders and populace vicinity Town B. Purpose: Influence to support peaceful religious observance				
TF X-XX (US) Armor	Task: Engage community leaders and populace in Municipality A. Purpose: Influence to conduct peaceful commutation						
TF X-XX (Russian) Infantry			Task: Combined MEDCAP/ DENCAP with XXXX Med Co. to K-Alb populace vicinity Town B. Purpose: Influence to not interfere with religious observance and demonstrate MNB(E) solidarity.				
X-X Engineer Battalion			Task: Meet with KPC unit counterpart. Purpose: Cooper to support non-interference with religious observance.				
XXXX Medical Company			Task: Combined MEDCAP/ DENCAP with Russian 8th to K-Alb populace vicinity Town B. Purpose: Influence to not interfere with religious observance and demonstrate MNB(E) solidarity.				

Figure 5. Information Operations Execution Matrix

The information operations Read File was a situational awareness tool for the MNB(E) leaders and staff. The LIWA FST NCOIC produced and distributed the information operations Read File daily. The Read File was a compilation of extracted information from MNB(E) and subordinate unit intelligence and operations reports, including commanders' SITREPs, and media reports prepared by the G2 OSINT section. Extracted information highlighted potential key events and activities that occurred throughout the MNB(E) areas of operation and interest for the preceding 24 hours with a focus on those that impacted the information environment. The consolidation of focused information from critical reports into a single document provided the MNB(E) leadership and staff with a brief synopsis that they could easily digest. The Read File also facilitated the information operations section's daily information operations assessment.

Information operations talking points were perhaps the most important tools the information operations section produced. Talking points provided MNB(E) leaders and soldiers with background information on key topics of direct operational relevance with related unclassified messages for specific or general delivery to community leaders and the local populace. Talking points provided the basic information and direction for conversations, but they were intended to be appropriately tailored for different audiences by the MNB(E) personnel delivering the information. Background information explained the issue, identified the intent or purpose for delivering the information, and provided any amplifying instructions, such as identifying specific populace groups that the information was intended for or for whom the information would be inappropriate. Following the background paragraph, factual information on the issue and related messages were bulleted for ease of use by MNB(E) personnel in face-to-face discussions with the populace and responding to questions from the media. MNB(E) leaders and soldiers participating in local radio and TV shows also used the talking points as did the PSYOP company in developing public service messages that were disseminated to locally contracted radio stations for periodic broadcast. The talking points were cross-walked with directed messages on the information operations TSM to prevent any conflict and ensure unity of effort in the information and messages the MNB(E) was disseminating. Talking points were published weekly and distributed to all MNB(E) staff and subordinate units through a FRAGO. Additionally, special information operations talking points were prepared and published in a FRAGO when a specific incident or issue arose

during the week and required immediate response from the brigade due to the potential for adverse impacts on the mission or a specific opportunity to advance accomplishment of the mission. Furthermore, specific talking points were developed for MNB(E) senior leaders' use in meetings with key local leaders that were directed by the TSM or called in response to an issue or problem related to the brigade's mission.

Information operations talking points were important for both the factual information they addressed as well as the messages that they provided related to that information. Although there was an overabundance of information that pertained to the MNB(E) sector and the local populace, topics, issues or incidents that were addressed in the talking points were selected for their operational relevancy to the brigade's mission of maintaining a safe and secure environment. Examples of talking points subjects include: serious incidents of ethnic violence such as murder or attempted murder; detention, arrest, trial, or conviction of a suspect in a highly publicized crime or a well-known local personality; transition of sector responsibility from one unit to another such as when the 1st Armored Division replaced the 1st Infantry Division as the USKFOR; significant examples of KFOR support to the local populace and specific communities; depleted uranium weapons use and other potential controversies related to the NATO bombing effort in Operation Allied Force; appropriate roles and activities for the Kosovo Protection Corps (KPC) and the progress of their transformation; renewed or suspected efforts to renew insurgency operations; and various efforts to restore normalcy to the sector such as refugee or prisoner returns and incidents of interethnic cooperation.

Talking points armed MNB(E) leaders and soldiers with current, factual information with which to defend themselves when questioned or confronted by the local populace, community leaders, or media representatives. The messages contained in the talking points also contributed to shaping the environment for future brigade operations. Furthermore, talking points in general advanced the accomplishment of the brigade's mission by establishing credibility for MNB(E) forces due to the soldiers' ability to provide factual information in a relatively timely manner, their capability to preempt or respond to misinformation or propaganda, and their desire and effort to impartially keep the local populace informed. Finally, information operations talking points ensured the continuity of topics, facts, and messages being disseminated by MNB(E) forces throughout the sector.

The information operations talking points used by MNB(E) leaders and soldiers were significantly different from media talking points normally produced by PA personnel, although the purpose for both is to ensure a continuity of information and messages. Information operations talking points were intended for use with any audience: the local populace, leaders or representatives from within sector or from the international community, and the media. Additionally, information operations talking points were written for use by all MNB(E) personnel, from senior leaders through the lowest ranking soldier. Key to the use of information operations talking points was for the speaker to tailor them to the situation and the audience. Finally, information operations talking points dealt with any topic of operational relevance to the brigade's mission, whether the topic concerned events, actions, or activities that directly pertained to U.S. forces or not.

The content of information and messages disseminated by MNB(E) personnel and units was nested as much as possible with the information and messages on the same or similar topics being disseminated by other agencies, including KFOR, UNMIK, NATO, and the U.S. Department of State. The information operations section relied on information from the KFOR PAO on many operationally relevant topics in Kosovo that exceeded the MNB(E) geographical or authoritative boundaries. Additionally, comments and press releases from the commander of KFOR, the chief of UNMIK, the NATO Secretary General, and representatives of the State Department regarding operationally relevant topics were used to provide strong support for MNB(E) messages to leaders and population groups in sector. Quotes and paraphrased information from those comments and press releases were included in information operations talking points and in directed messages for nonlethal engagements. Analysts in the Information Division at the LIWA forwarded to the information operations section copies of classified messages on various operationally relevant topics. Some messages provided unclassified talking points on those topics and were provided for use by U.S. government and military personnel in the European region conducting meetings or activities related to Kosovo. The information operations section ensured that any MNB(E) information operations talking points or directed messages released in sector pertaining to those same topics agreed with the information and talking points being used by other government and military personnel.

Information Operations Assets and Capabilities

Information operations in MNB(E) were conducted primarily through the use of PSYOP, CA, PA, MNB(E) headquarters, and major subordinate unit assets to deliver the selected information and targeted messages. Doctrinally, information operations can consist of a variety of major lethal and nonlethal capabilities and activities, including operations security (OPSEC), PSYOP, military deception, electronic warfare (EW), physical attack/destruction, computer network attack (CNA), PA, and CA.⁹ Due to the inherent operational constraints of peacekeeping and an underdeveloped, dilapidated local information infrastructure, MNB(E) information operations consisted of a limited set of these capabilities and activities. Additionally, the extent and manner in which subordinate multinational battalion task forces implemented information operations in their sector depended on their organic assets and their own national policies and procedures.

The U.S. Army Reserve PSYOP company attached to MNB(E) consisted of assets capable of disseminating operationally relevant information and associated messages to support the brigade's mission. In addition to producing and disseminating handbills, posters, and other print products, the company also was capable of producing radio and TV programming. Perhaps the most prolific PSYOP asset, however, was the Tactical PSYOP Team (TPT). Three TPTs provided coverage throughout the brigade sector. The TPTs disseminated PSYOP products to the public and conducted loudspeaker operations and, perhaps most importantly, face-to-face PSYOP, which along with the maneuver battalions' presence patrols was a significant information operations capability. TPT personnel gauged the target audience's attitude and adjusted their delivery as needed. TPT members were also trained and experienced in persuasion and influence techniques that are not common capabilities of the average soldier. Further, TPT personnel were able to assess the immediate effects of their engagements and detect changes in behaviors and attitudes in later visits to the communities. PSYOP personnel conducted engagements directed by the MNB(E) targeting process and also used information operations talking points for targets of opportunity. TPTs were directed to attend MEDCAP and DENCAP visits as well as civil-military project events, such as kick-off ceremonies and project completion celebrations, to capitalize on the opportunities those activities presented for engaging and influencing target audiences. PSYOP personnel also provided relevant information on

topics and issues germane to the MNB(E) mission that they collected and observed during their conversations and movements.



Figure 6. A Tactical PSYOP Team Member from MNB(E) Disseminates Information in Kosovo

Although the PSYOP company had limited organic capabilities for broadcast media production, they carried out a major effort in developing radio broadcast capabilities. The company's capability in developing radio programming was significantly enhanced through the addition of a broadcast media specialist from the PAO. Local radio stations were contracted to broadcast MNB(E) information and messages. The number of contracted stations grew phenomenally from 6 in April 2000 with a regional broadcast coverage limited to portions of 5 of 7 municipalities in the Brigade's sector, to 14 by the end of July with coverage that extended to all the municipalities. The initial limited coverage primarily was due to the small number of operational local radio stations. As the number of stations grew, the PSYOP company took advantage of the opportunities to expand broadcast coverage for dissemination of information and messages to support the MNB(E) mission. The first operational TV station in sector did not emerge until July 2000 and the PSYOP company was preparing to initiate a similar vigorous effort with TV broadcasting as they did with radio. In addition to producing radio public service announcements, the PSYOP company scheduled and

prepared MNB(E) headquarters personnel for appearance on live radio shows. The PSYOP company and the information operations section coordinated each week on topics, facts, and messages appropriate for the public service announcements and radio shows. Additional coordination was conducted after shows in which call-in questions were received from the local populace to ensure follow-up facts and messages were optimally addressed in later appearances. By July 2000, each maneuver battalion task force commander had a contracted radio station available in his sector to conduct weekly live radio shows.

The PSYOP radio effort played a key role in the MNB(E) information operations effort since it played both an economy of force and force multiplier role. Radio allowed the rapid dissemination of information and messages relevant to the brigade's mission throughout the sector without requiring a physical presence to convey them. Radio public service announcements and live radio shows also emphasized information and messages focused on maintaining a safe and secure environment, thereby multiplying the effects of those disseminated through key leader engagements, face-to-face PSYOP, PSYOP printed products, press releases, or force presence patrols.

The nature of public affairs operations in MNB(E) changed significantly during the summer of 2000 from a reactive approach to a more aggressive active effort. The U.S. Army Reserve Mobile Public Affairs Detachment (MPAD) attached to the MNB(E) coordinated and facilitated media operations and produced unit internal information products. Internal information products included *The Falcon Flier* command newspaper. The commander of the MPAD also functioned as the brigade Public Affairs Officer. PA operations included press releases, media escorts, and press interviews with MNB(E) leaders. Up through June 2000, the MPAD pursued reactive media operations: producing press releases when directed by the MNB(E) leadership, escorting media representatives when notified, and taking a generally neutral stand when providing information to the media that entailed releasing only facts with no associated messages. The MPAD rotated in July 2000 and with the change in unit came a more active approach to media operations. The new MPAD initiated press releases to ensure the facts surrounding events that could impact the MNB(E) mission were released as quickly as possible to head off possible misinformation or propaganda. The MPAD coordinated with the information operations section to ensure that appropriate MNB(E) messages were released.

The MPAD also coordinated with the information operations section on facts and messages to use in preparing senior MNB(E) leaders for press interviews and speeches.

The civil-military operations (CMO) conducted in the MNB(E) sector contributed significantly to influencing the behavior and attitude of the populace and local leaders. The CA battalion attached to MNB(E) was also from the U.S. Army Reserve. Tactical Support Teams (TSTs) from the CA battalion operated in all maneuver battalion task force sectors to coordinate civil-military projects and humanitarian assistance. CA personnel also conducted face-to-face meetings with the local population, community leaders, UNMIK representatives, and international organizations such as the Red Cross and the World Food Program.



Figure 7. A CA Soldier from MNB(E) Interfaces with the Local Populace

Civil-military operations were coordinated rather than specifically integrated with the information operations effort, except in those instances when sanctions were imposed on specific communities and KFOR civil-military projects and humanitarian assistance were withheld to send specific messages to a community. Instead, information operations leveraged civil-military projects and humanitarian assistance for information purposes and used that information to project effects

in the local community, the municipality, and in other communities and municipalities in sector. In addition to standard civil-military projects such as utilities repair and schools construction or repairs, CA personnel also coordinated small-scale employment projects and local business rehabilitation sponsored by the international community as well as intercommunity and interethnic business cooperation. Humanitarian assistance efforts by the CA battalion included escorting Kosovar Serbs to medical and other social welfare visits in or through Kosovar Albanian communities, coordinating for food and clothing donation distributions to specific families and communities, and coordinating for specific medical assistance to individuals, families, and communities. Combat Camera, PA representatives, and CA personnel worked with the information operations section to capture information about specific CMO conducted in sector. This information was then included in press releases, PSYOP products, and information operations talking points used throughout the sector to persuade the public and local leaders of the benefits of cooperating with MNB(E). Additionally, a CA representative attended operations planning and targeting meetings to synchronize CMO with the maneuver and information operations plans.

The high quality medical care provided by MNB(E) medical personnel played a key role in the brigade's information operations effort. Emergency medical care was provided by the Camp Bondsteel medical treatment facility to any person with the threat of loss of life, limb, or eyesight. The quality of medical care that was provided at the Camp Bondsteel medical facility was renowned throughout Kosovo. Kosovar Serbian residents from even the most uncooperative, hard-line communities (such as Strpce) willingly received emergency medical treatment at Camp Bondsteel. A leading Serbian Orthodox cleric in sector who was seriously injured in a drive-by shooting required a series of medical treatments at Camp Bondsteel. He reported that wealthy relatives offered him the opportunity to receive medical treatment elsewhere, but he declined, as he trusted the care he was receiving at Camp Bondsteel. The former KLA leader and resurgent political celebrity Ramush Haradinaj was transported to Camp Bondsteel for medical treatment after being injured in a confrontation in MNB(W). In addition to the emergency medical treatment provided at the Camp Bondsteel medical treatment facility, teams of medical and dental treatment personnel from MNB(E) provided care throughout the sector through the MEDCAP/DENCAP. This medical and dental care was provided to

augment civilian care that was either inadequate or unavailable in specific communities.



Figure 8. High-Quality Medical Care Provided by MNB(E) Played a Key Role in Sending Messages to the Local Populace in Kosovo

As with CMO, the information operations section coordinated with other MNB(E) elements to leverage brigade-provided medical and dental care for information purposes to influence the attitudes and behaviors of the local leaders and populace. Combat Camera, PA representatives, and MNB(E) medical personnel worked with the information operations section to capture the information. The information was then disseminated in press releases, PSYOP products, and information operations talking points throughout the sector to further reinforce the benefits of cooperating with MNB(E). MEDCAP and DENCAP visits also were prime opportunities for disseminating operationally relevant information and messages to local target audiences. Therefore, PSYOP teams were directed to selected MEDCAPs and DENCAPs to seize those opportunities. The medical planner from the staff Surgeon's Office attended the brigade's operations planning sessions and targeting meetings to integrate scheduled MEDCAPs and DENCAPs into the concepts of operations and nonlethal engagements. This integration of MEDCAP and DENCAP planning with the brigade's operations and targeting ensured that scheduled medical and dental assistance not

only went to communities that needed it, but also were synchronized with planned information operations activities and supported achieving the brigade's mission. The staff surgeon maintained historical information on MEDCAP and DENCAP visits to support assessments and for use in future planning and targeting efforts.

Members of the MNB(E) command group and staff conducted engagements and assessments of key local leaders and target audiences. The MNB(E) commander, the U.S. brigade commander, the deputy commander for Civil Affairs, and the MNB(E) chief of staff conducted face-to-face meetings with key local formal and informal leaders to deliver messages supporting the brigade's mission. Some of these were specifically directed during the MNB(E) targeting meetings or coordinated with the information operations section to ensure continuity of messages and some were conducted on the command group's initiative. A number of MNB(E) staff officers also conducted meetings with key leaders and target audiences. These included the G5, who was also the CA battalion commander, the Political Advisor (POLAD), the Deputy G3, the Staff Judge Advocate, the Provost Marshall, the chaplain, and the Joint Implementation Commission (JIC) Officer. Again, some of these meetings were targeted meetings or coordinated with the information operations section and some were not. The JIC Officer was principally responsible for monitoring the implementation within sector of all facets of the international agreement to establish the KPC. In that capacity, he held various meetings with KPC leaders and key staff personnel. The MNB(E) JIC also attended and facilitated weekly meetings on sector security with representatives of the international community, including UNMIK. Although the information operations section did not coordinate or target messages for all the JIC meetings, the section did provide the JIC information and messages for key target audiences as determined during operations planning or the weekly targeting meeting. Also, members of the MNB(E) staff, such as the MNB(E) staff surgeon and the POLAD, appeared on radio shows to present information and messages to the populace in their dialogue and in their responses to listeners' questions.

Force presence provided an unparalleled capability for the MNB(E) information operations to influence the behavior and attitudes of local community leaders and the populace in sector. Multinational battalion task forces and other major subordinate units such as U.S. Army engineers and U.S. Army military police provided the assets that

maintained that force presence to include interacting with local leaders within the towns and municipalities. Battalion task force commanders were responsible for engaging the local leaders within their assigned sectors. Daily patrols, fixed and roving checkpoints, and deliberate operations to maintain a safe and secure environment such as cordon and search operations presented opportunities for MNB(E) soldiers and junior leaders to disseminate information and messages to the populace and their community leaders. The Milosevic regime maintained representatives and supporters in sector and ethnic Albanian extremists maintained pockets of support throughout the sector. However, neither camp had the ability to have a presence anywhere in sector at any time, nor did they maintain a respected level of credibility among a large portion of the populace as MNB(E) forces did. Soldiers from MNB(E) had the capability to provide a respected presence anywhere in sector. As a result of MNB(E)'s emphasis on treating any resident of Kosovo with respect and dignity, as well as its efforts made to present factual, current information, MNB(E) soldiers were able to provide a credible presence throughout the sector that made them perhaps the most effective information operations asset.



Figure 9. Force Presence Provided a Vital Information Operations Capability in Kosovo

Strpce, June 2000: A Brief Example of Information Operations

In late June 2000, the town of Strpce in the southwestern portion of the MNB(E) sector erupted in a melee of destruction and violence. The Kosovar Serbs attacked the UNMIK municipal administrative headquarters and wantonly destroyed furniture and office equipment. Attempts were made to set the building on fire, but were unsuccessful. The reported cause of the mayhem was simple displeasure with the UNMIK administrator and his methods.

As a result of the attack on UNMIK, the MNB(E) commander imposed sanctions on the Serbian populace in the municipality. These sanctions included withholding medical or dental treatment teams' visits and postponement of civil-military projects, both in progress and planned, for the Serbian community in Strpce. Additionally, the MNB(E) commander cancelled security escorts for bus and automobile convoys travelling from Strpce to Serbia through ethnic Albanian towns. These convoys were the only way for Serbs to leave or enter the remote Serbian enclave. The convoys were at great risk of attack as they passed through ethnic Albanian towns and without the KFOR security escorts most residents were unwilling to take the risk.

MNB(E) headquarters representatives, Polish and Ukrainian soldiers on patrol with U.S. Army Special Forces liaison personnel, CA personnel, and PSYOP teams disseminated information on the sanctions to local Serb community leaders and the populace in and around Strpce. Included with the sanctions information were messages urging cooperation and compliance. The information was also provided to an MNB(E) contracted radio station in the neighboring town of Brezovica with the intent of reinforcing the pressure on their Serbian colleagues in Strpce. Furthermore, to exploit the effects of the Strpce sanctions by apprising other Kosovo residents of the projects and assistance that the Serbian community in Strpce was losing, information on the imposed sanctions was disseminated throughout the MNB(E) sector to Kosovar Serbs and ethnic Albanians alike. Combined with other information on the projects and assistance that MNB(E) was providing sector wide, the information directly supported messages urging cooperation from sector residents.

The Deputy Commander for Civil Affairs subsequently met with local Serb leaders to reinforce the message of the sanctions. MNB(E)'s demands included the peaceful detention of individuals suspected of leading the attack on the UNMIK offices. The April riot in the Strpce municipality was the result of an angry crowd opposing the detention of a Serb resident suspected of caching weapons in his house and the MNB(E) commander intended to avoid a similar violent confrontation. The locations of the suspected leaders were identified and an operation mounted for their arrest. Messages in the form of information operations talking points were provided to the forces conducting the detentions for use in explaining their actions to local residents and preventing violent reactions. TPT personnel distributed fliers during the operation and radio messages were provided to the Brezovica radio station to reinforce the talking points. When the suspected leaders were detained, a small crowd gathered and then soon dispersed. No subsequent violence ensued, Serb leaders acquiesced to MNB(E)'s demands, and the MNB(E) commander lifted the sanctions within less than a week of their being imposed.

Issues and Problems

Assessment of the overall contribution of information operations to progress in MNB(E)'s sector and of the effectiveness of any given information operations engagement was difficult. Information operations' measures of effectiveness (MOE) are subjective, and obtaining reported information that supports quantitative analysis of nonlethal engagements is difficult.¹⁰ After all, assessment of changes in people's attitudes and behaviors are not as readily identifiable as the destruction of physical assets. As anticipated, information operations MOE and effects from nonlethal attacks were highly subjective, based more on qualitative changes rather than quantitative results, and dependent on interpretive judgment as opposed to physically discernible changes. The challenge of information operations assessment was made more difficult by a lack of disciplined reporting from those assets and units that conducted information operations activities and nonlethal engagements. At times, the information operations section was unable to determine whether a directed engagement or tasked activity was even executed, let alone the effects or amount of success achieved. Although assessment reporting from the battalion task forces improved greatly after the transition to rotation

2A in June 2000 when battalion FSOs assumed the role of task force information operations officers, nonlethal engagements by leaders and staff officers from MNB(E) headquarters still went unreported at times, especially those that were conducted on commanders' or staff officers' own initiatives without prior coordination and synchronization in operations planning or the targeting process.

Lack of coordination on various nonlethal engagements, including some conducted by MNB(E) headquarters' senior leaders and staff members, presented other problems beyond ineffective assessment. Principal among these problems was a lack of continuity in information and messages. In one instance, a primary staff officer from MNB(E) informed key representatives of the Kosovar Serbian community of the brigade's intent to pursue a certain course of action while senior leaders recommended to the commander not to continue with that same course of action. In other instances, the lack of coordination simply resulted in missed opportunities. For example, artillery at Camp Bondsteel fired illumination rounds in support of nighttime searches and patrols. Although coordination was conducted with the information operations section for talking points to generally warn the populace of the artillery firing (but not of specific missions) and inform them of the purposes of the illumination missions, no specific coordination was conducted to analyze and select communities or areas in sector where the firing of illumination missions in themselves could send a message of warning or, conversely, of security. Another problem resulting from lack of coordination on some nonlethal engagements was the engagement of the wrong person as a key decisionmaker. Especially after the transition of authority for the sector from the 1st Infantry Division to the 1st Armored Division while the new unit's personnel were still inexperienced with the sector's situation, regional and community leaders were engaged that were inappropriate for the task at hand. That is, sometimes local leaders were engaged who were not the key decisionmakers for a specific group or were not subject to MNB(E)'s influence. Most of the latter fell into the category of criminals or hard-line nationalists who had no real motivation to cooperate with MNB(E) unless they could be detained for a significant period of time or brought to trial.

OPSEC was applied more from an administrative perspective within the MNB(E) headquarters rather than an operational imperative planned and executed in the brigade's operations. Policies and procedures were established and overseen for the garrison-type activities such as

physical security of facilities and protection of classified materials, but focused planning and implementation of potential vulnerabilities and related protective measures for operations were limited at best. Additionally, the brigade headquarters did not actively oversee implementation of OPSEC at the subordinate battalion task forces.

Not enough attention was placed on what messages or influences the ethnic Albanians or Serbs may have been putting forth in their contacts with MNB(E) leaders and forces. MNB(E) leaders, staff officers, and soldiers interacted with regional and community leaders and the populace in sector on a daily basis. In spite of the various conversations that were being conducted and reported and the fact that MNB(E) was using these contacts to send messages to target audiences, there was no deliberate effort to analyze whether the local leaders and populace were likewise sending messages to MNB(E). The target audiences' responses to MNB(E) messages were analyzed only to determine success or failure, but not to determine if the audiences were disseminating messages in return. Analyzing the local leaders' and populace's conversations and statements for either explicit or implicit messages could have been critical to the information operations effort as the messages could have indicated an operational focus for groups wishing to influence MNB(E) leaders and soldiers and possible MNB(E) attempts to prevent any adverse impact on the mission.

Nonlethal targeting for information operations was conducted only by MNB(E) and not by KFOR or any other MNB. Because there was no influence being exercised on leaders or population groups external to the MNB(E) sector that may have had associated elements targeted by MNB(E), the opportunities to compound that influence province wide were missed. Additionally, efforts to influence leaders and population groups external to the MNB(E) sector could have facilitated MNB(E)'s information operations against related leaders and groups in sector.

In addition to not conducting nonlethal targeting, KFOR did not have an overarching, long-range information operations plan that integrated the efforts of the MNBs towards specific objectives. Instead, the KFOR information operations section provided occasional guidance at the weekly KFOR IOWG meetings. This guidance usually focused on specific information to be disseminated by the MNBs as opposed to focused tasks and purposes to achieve an integrated end state. Of course, the lack of common KFOR information operations doctrine and procedures

meant that any effort to integrate the MNBs' information operations would have been executed disparately and therefore perhaps achieved less than effective results. Thus, the MNBs' information operations consisted mostly of segregated efforts conducted with varying processes and procedures to attain different objectives and effects.

Civil-military operations and humanitarian assistance projects were ideal opportunities to present messages and information to captive audiences, but CA personnel were hesitant to do so. This hesitancy was generally due to the personnel feeling uncomfortable conducting information operations since they did not believe that the HA or CMO event was an appropriate time to attempt to influence local populace members or they felt that opportunities did not present themselves to disseminate the information and messages. This hesitancy to conduct information operations may have been overcome with more training focused on how to present operationally relevant information and messages.

Nonlethal engagements of inappropriate targets and the sending of inappropriate messages occurred many times because MNB(E) leaders and soldiers, including U.S. soldiers, were not sufficiently trained to consider or even be aware of the potential information impact of their every action. Any actions conducted by MNB(E) personnel could send a message, good or bad. Unfortunately, on various occasions MNB(E) leaders and soldiers took actions that sent inconsistent and contradictory messages to those that the command was trying to present. For example, any event conducted by MNB(E) units or staffs that smacked of military training for the KPC ran counter to the effort of converting them to a civil organization, sent contradictory messages to the KPC leaders and members as to MNB(E)'s position, and presented the wrong image to the populace and the international community. As another example, MNB(E) forces would engage local informal leaders who were influential in their communities, but who were not supportive of MNB(E) or UNMIK. MNB(E)'s engaging them legitimized and empowered them further as it gave the image to other leaders, including official ones, as well as the populace that MNB(E) considered the informal leaders to be the community power brokers. Although these leaders may have been able to achieve results, their increased power only allowed them to further oppose MNB(E) or UNMIK and sent contradictory messages to the populace since the informal leaders opposed MNB(E) or UNMIK. Once again, these incidents of MNB(E) leaders and forces conducting inappropriate engagements and sending

inappropriate messages probably could have been reduced with effective training.

Conclusion

The performance of information operations in Kosovo by MNB(E) demonstrated the utility of information operations in peace operations. Moreover, information operations in Kosovo has shown the benefits of information operations in tactical Army operations, albeit in a limited, nonlethal, and primarily nontechnical applications. The success that has been achieved in the MNB(E) sector with the application of information operations occurred because of its integration with the MNB(E) overall operations through the use of standard decisionmaking and targeting processes that soldiers are familiar with and experienced in from training for and conducting combat operations. The tactics, techniques, procedures, and processes used to conduct information operations in Kosovo were previously used in Bosnia and continue to be applied and refined now in Kosovo. These operations are developing a pool of Army soldiers experienced with information operations, at least in peace operations, and perhaps growing to appreciate its benefits and contributions.

Tactical Army leaders' and soldiers' experience with and appreciation of the contributions of information operations in Kosovo should provide the impetus for increasing consideration of its use in combat operations. Teams from the Land Information Warfare Activity have worked with Army units to facilitate the integration. To date, progress on integrating information operations into Army operations has been slow and leaders have been unwilling to invest their own unit resources in conducting operations in the information environment. Although familiar processes and procedures have been used in implementing information operations, applying it is still a relatively complex effort. The complexity of applying information operations is perhaps a significant obstacle to its integration in tactical Army operations. The application of information operations requires a different perspective and focus than the normal Army emphasis on firepower and maneuver. Nevertheless, the tactical success achieved in contingency missions such as Kosovo and Bosnia provide clear indications of the potential benefits of applying information in conjunction with maneuver and firepower to accomplish a tactical Army mission. Perhaps these

experiences with information operations in peace operations will shape the environment for future Army operations.

¹This chapter discusses tactics, techniques, procedures, and processes that the Multinational Brigade-East information operations section used in Kosovo from April through July 2000. Although the information operations section continued to function similarly, the methods and means for planning, executing, and assessing information operations continued to evolve. For the most current tactics, techniques, procedures, and processes in use by the MNB(E) information operations section, see MNB(E)/Task Force Falcon (TFF) Standard Operating Procedures. This chapter is only the author's opinion of what transpired and does not constitute an official position of the Land Information Warfare Activity, the Multinational Brigade-East, or the U.S. Army.

²U.S. Joint Service Staff, Joint Publication 3-13, *Joint Doctrine for Information Operations*, 9 October 1998, p. I-3.

³*Ibid.*, definition of information operations on p. I-9.

⁴Ralph Peters, "The Plague of Ideas," in *Parameters*, U.S. Army War College Quarterly, Volume XXX, Number 4, Winter 2000-01, p. 18. Mr. Peters discusses true information wars as being about information that is "culturally permissible." He states that "The closest military organizations come to the real challenge is when they attempt, amateurishly, psychological operations campaigns or fumble with 'perception management'." The MNB(E) information operations effort avoided a futile effort at fighting or modifying the truth and instead focused on ensuring factual information was made available to the populace.

⁵ Christopher Layne, "Collateral Damage in Yugoslavia," in *NATO's Empty Victory*, ed. Ted Galen Carpenter (Washington, D.C.: Cato Institute, 2000), p. 55.

⁶U.S. Army Land Information Warfare Activity (LIWA), *LIWA Information Operations Handbook (Draft)*, October 1998, p. 2-5.

⁷Headquarters, U.S. Department of the Army, U.S. Army Field Manual (FM) 101-5, *Staff Organization and Operations*, 31 May 1997, p. 5-1.

⁸*Ibid.*, pp. H-16 and H-64.

⁹Joint Pub 3-13, p. I-9.

¹⁰*LIWA Information Operations Handbook (Draft)*, p. 7-10.

SECTION 5—TASK FORCE FALCON: A SNAPSHOT IN TIME

CHAPTER XV

Introduction

Larry Wentz

The Untold Story

The men and women who devote their time and effort to saving and protecting the lives of others rarely get the public recognition they deserve. The sacrifices they make, the hardships they endure, and particularly the outstanding work they do on the behalf of the United States all over the world, are all part of a great untold story. That is the story I want to help tell, the story of the peacekeepers.

As the former U.N. Secretary General Dag Hammerskold once said, “Peacekeeping is not a job for soldiers, but only a soldier can do it.” These operations are not glamorous and do not command the same long-term media attention as warfighting operations, even though many times they are just as dangerous. In peace operations, the story begins when the media arrives, which in most cases is before the military operation begins. The arrival of CNN’s Christiane Amanpour often signals the beginning of important events and the rest of the media will not be far behind. The peace operation story effectively ends when the media goes home, although the operation itself may continue for years.

The NATO-led Kosovo ground operation, Operation Joint Guardian, is such a case. The suffering and injustices leading up to the military intervention received plenty of media coverage. Active media coverage continued throughout the military entry and initial force deployments and continued up to the time of stabilization—reduced violence, disarming of the KLA, and the return of many Kosovar Albanian refugees. At that point, most of the media went home. As a result, the real story of the day-to-day experiences of the troops on the ground received little attention. There were exceptions when special events, such as Thanksgiving and Christmas, got some limited coverage.

Unfortunate events, such as the accidental shooting of a 6-year-old Kosovar-Albanian boy by a U.S. soldier, received intensive (albeit brief) media attention.

These chapters of Section 5 attempt to tell a part of this untold story by sharing my experiences in Kosovo. I worked for 6 weeks with a dedicated workforce of U.S. military personnel, civilians, and contractors, as well as our multinational partners. All of these people and organizations were trying to protect and restore a devastated land. The observations and shortfalls presented herein are not meant as criticism. Everyone with whom I came into contact worked hard to make a difference in this most difficult and complex environment. Exposing some of the day-to-day challenges they had to overcome in order to make a difference will hopefully serve to educate others and better prepare those who may participate in future peacekeeping operations. The experiences in some cases represent lessons revisited while others are lessons yet to be learned. Every day was new and brought a new set of opportunities and challenges.

Luck of the Draw

It was bright and sunny on May 26, 2000, when Major Dan Cecil, U.S. Air Force, and I boarded the U.S. Army Black Hawk at the commercial airport in Skopje, Macedonia. Major Cecil, my military escort, was a member of the European Command (EUCOM), J6 Joint Operations Center. We had arrived in Skopje just a few minutes earlier after a two-and-a-half hour flight from Stuttgart Army Airfield, Germany. Mr. Ed Robley, Multinational Brigade-East (MNB(E)) Joint Visitor Bureau, met us for the half-hour chopper ride to the VIP pad at Camp Bondsteel, Kosovo (Figure 1). As the chopper approached the pad, we got our first glimpse of the dust that would be part of our daily life during our time at Bondsteel. The temperature upon my arrival was in the high 90s and remained unchanged for most of my stay.



Figure 1. Author's Arrival at Camp Bondsteel May 26, 2000

The visit could not have occurred at a more fortuitous time. It was nearly a year into Operation Joint Guardian. EUROCORP was in its early phase of its control at Kosovo Force (KFOR) headquarters. The Task Force Falcon (TFF) U.S. 1st Infantry Division was preparing to transfer authority (TOA) to the 1st Armored Division. The atmosphere was one of high operations tempo (OPTEMPO). There was a likelihood of hostilities erupting. Preparation for the TOA was well underway with new troops showing up at Camp Bondsteel every day. Massive local celebrations were being planned by the Kosovar Albanians for June 12th to honor the first anniversary of the liberation of Kosovo by the UCK and the arrival of KFOR forces. KFOR was concerned that these celebrations might not be peaceful. Roadside monuments bearing the UCK symbol and Albanian flag started to appear in early June to honor those who died in the fight for freedom against the Serbian military. In some cases, the U.S. flag was also flown alongside the Albanian flag.

BG Croom, U.S. Air Force, EUCOM J6, was the European theater sponsor of my visit. Lt. Col. Earl Matthews, U.S. Air Force, facilitated things at the EUCOM level. The commander of MNB(E) and TFF, BG

Sanchez, U.S. Army, his Chief of Staff, COL Al Landry, U.S. Army, and MAJ Peter Jones, U.S. Army, of the G3 plans shop sponsored the in-country visit and opened the doors necessary to make this a successful “quick look” into the lives of the soldiers on the ground, the day-to-day operation of TFF, the challenges they faced, and the ways in which they made a difference. There was a mutually beneficial situation in my helping them with their after action review (AAR) and them helping me get access to information to tell the TFF story. 2LT Brendan Corbett, U.S. Army, of G3 plans was our in-country escort and responsible for coordination of activities.

Opportunity to Get Some Firsthand Experience

During the 6-week period of my stay in Kosovo, I was given the opportunity to observe firsthand the day-to-day headquarters and intelligence operations of TFF and to participate in field operations within the area of responsibility of MNB(E), including visits to some of the non-U.S. force elements supporting the task force. LTC Hogg, U.S. Army, and LTC Greco, U.S. Army, were instrumental in facilitating my participation in TFF operations and intelligence activities. Many officers facilitated my excursions from Camp Bondsteel:

- LTC Beard, U.S. Army Reserve, provided me numerous opportunities to participate with his civil affairs teams working in Gnjilane, Kamenica, Vitina, Kacanik and Strpce.
- MAJ Rangle, U.S. Army Reserve, arranged for me to accompany his PSYOP teams on visits to a PSYOP funded radio station in the Serbian village of Silovo, as well as to the villages of Bilince, Lovce, Gronja Stubla, Vrnez Letnica, and Zegra.
- CPT Davis, U.S. Army Reserve, took me along on a PSYOP team visit to the Serbian village of Susice to distribute some clothing and toys for children of the village.
- LTC Kokinda, U.S. Army, organized tours and briefings of the U.S. communications operations on Camps Bondsteel and Montieth and a Black Hawk helicopter aerial tour of the MNB(E) sector with visits to U.S. communications sites at the Polish, Greek and Russian camps.

- MAJ Lin Crawford, U.S. Army, organized a visit to see a “CONOPS” package deployment at a counter infiltration operations outpost called “Eagle’s Nest” near the Serbian border in the town of Plavica and the “Rock” communications facility on Camp Bondsteel.
- MAJ Brown, U.S. Army, invited me to participate in TFF Information Operations cell activities and the weekly KFOR-sponsored IO working group meetings.
- MAJ Allen, U.S. Army Reserve, organized visits with the public affairs team and participation in a Public Information Officers’ working group meeting sponsored by KFOR.
- MAJ Irby, U.S. Army, facilitated visits to KFOR headquarters, the United Nations Interim Administration Mission in Kosovo (UNMIK), and the Organization for Security and Cooperation in Europe (OSCE) in Pristina.
- Captain Barwikowski, U.S. Army, facilitated visits with the Special Forces team, the MPs, 1-187 IN, and the UNMIK police in Vitina.
- 1LT Vitello, U.S. Army, made arrangements for me to accompany the combat camera team on several missions, one of which provided me the opportunity to observe a Medical Civil Action Program (MEDCAP) team in action in the Serbian village of Kmetovce.
- Warrant Officer Battagua, Italian Carabinieri, invited me to go along with them to Vrnez to look for smuggling routes.
- Checkpoint Sapper overlooking the Presovo valley and the village of Dobrosin were visited several times with civil affairs, public affairs and combat camera teams.

As an outside observer, it was impossible for me to acquire the same depth of knowledge of the operation as that of those stationed at Camp Bondsteel. The men and women I spoke to had to carry out missions every day for six months. My observations were only cursory, but gathered from soldiers at many levels of the task force. The findings and observations presented herein will hopefully provide insights to the

breadth and depth of peace support operations activities, some of the issues they needed to deal with and the difficulties of adapting traditional structures to new missions and technologies. No two operations were ever really quite the same so new lessons were learned every day. There were some similarities to Bosnia, but there were also many differences that made Kosovo a new adventure for those who participated.

Task Force Falcon Background

There were U.S. forces already in Macedonia supporting the U.N.-sanctioned operation Task Force Able Sentry, which monitored the Serbian border. NATO deployed the Allied Command Rapid Reaction Corps (ARRC) to the Former Yugoslav Republic of Macedonia in February 1999 in anticipation of achieving a cease-fire agreement. Task Force Falcon was activated on February 4, 1999. It was initially envisioned to be a reinforcement brigade to serve as the U.S. component of a NATO-led Kosovo Force whose mission would be to conduct peacekeeping operations in Kosovo to support the Rambouillet Peace Accords. The 1st Infantry Division (the Big Red One) was earmarked for this mission and began training in March 1999 while diplomatic discussions continued. Failure to achieve a diplomatic agreement with Milosevic resulted in NATO initiating the air campaign Operation Allied Force on March 24, 1999. Both NATO and U.S. forces were in Macedonia as NATO prosecuted the air war to force Milosevic to capitulate. In April, Task Force Hawk deployed to Tirana for possible use in conducting deep strike operations in support of the air war. The 26th Marine Expeditionary Unit (MEU) deployed to Fier, Albania near the end of April to provide physical security for Camp Hope, a Kosovar refugee camp managed by the U.S. Air Force. In early June, an agreement with Belgrade was achieved to permit the unopposed entry of KFOR into Kosovo under the Military Technical Agreement in support of UNSCR 1244.

The 1st Infantry Division Commander called upon the 2nd Brigade, 1st ID, to immediately deploy, under the command of BG Craddock, U.S. Army. Elements of U.S. Task Force Hawk were relocated from Albania to Macedonia within hours of the Serbian acceptance of the terms to end the bombing. The 26th MEU was ordered to turn over the security mission to the U.S. Air Force and immediately proceed to Macedonia to support peace operations in Kosovo. The U.S.S. Kearsarge transported

the Marines from Albania to Greece. They then traveled by convoy to Macedonia and the KFOR staging area near the Kosovar border. As a result, the U.S. enabling force led by the 2nd Brigade Combat Team included not only U.S. Army forces but also the 26th MEU.

On June 12, 1999, the U.S. element of the KFOR force entered the war-torn province of Kosovo by land and air. U.S. Army paratroopers successfully staged an air assault and raised the American flag on a hill near Urosevac (the future site for Camp Bondsteel) and awaited the arrival of the initial land entry force led by BG Craddock. The following day, Task Force Falcon established its headquarters at Camp Bondsteel on the hilly land a few miles west of Urosevac. A few days later, the 26th MEU occupied the city of Gnjilane and the surrounding area. The MEU established its presence as a force with authority, power and conviction. As the Marines put it, "We came to win, others came not to lose." In early July, the Marines were replaced by U.S. Army elements. The U.S. entry force quickly grew into the Multinational Brigade East, which was composed of forces from eight nations: Greece, Jordan, Lithuania, Poland, Russia, Ukraine, United Arab Emirates, and the United States.

When the peacekeepers first entered Kosovo in June, thousands of Albanians were feared dead and more than a million people had been driven from their homes. The government and all civil services had collapsed. Pristina, the capital city, was deserted. There were no border guards. Merely securing the borders proved an enormous task as KFOR units and Kosovar refugees flooded into the province.

On August 12, 1999, BG Craig Peterson, U.S. Army, assumed command of MNB(E)/TFF. Violence and lawlessness decreased as winter approached but did not cease entirely as ethnically motivated troubles continued. In October 1999, MNB(E) repositioned forces along ethnic fault lines. Gradually violence began to decrease.

On December 10, 1999, BG Rick Sanchez, U.S. Army, assumed command of MNB(E)/TFF and the 3rd Brigade, 1st ID, assumed the TFF mission. During the winter months, MNB(E) continued to expand its presence throughout the U.S. sector. They also began to prepare for possible increases in ethnic violence and insurgency activities. This new focus expanded the MNB(E) mission beyond purely peace support operations and introduced expanded-boundary security and counter-insurgency operations.

In January and February of 2000, MNB(E) began to see nascent insurgent activity along the Kosovo-Serbia border and an increase in ethnic violence, particularly in the French sector and Mitrovica. From February 19 to 24, 2000, TFF elements were sent to MNB(N) to support KFOR efforts to quell ethnic violence and tensions in the divided city of Mitrovica.

Throughout the spring, MNB(E) continued to demonstrate and foster multinational support and interoperability during Operation Dynamic Response 2000. This coordinated effort was frequently needed to combat violent civil disturbances. Two major crowd control actions in Serbian dominated towns occurred. One on March 1, 2000, in Gornje Kusce was the result of soldiers arresting a weapons violator during a routine house search operation. The other happened on April 4, 2000, in Sevce where another weapons violator was arrested. These events required MPs to use riot gear and K9 dog team. The commander at the disturbance in Gornje Kusce requested permission to use non-lethal weapons, but was denied. However, non-lethal weapons were permitted at Sevce. Nineteen TFF personnel were injured during the Sevce riot. On March 15, MNB(E) elements attacked multiple sites along 28 kilometers of enemy territory to seize weapons and ammunition. This operation communicated KFOR's and MNB(E)'s determination to preserve the peace in Kosovo to the civilian population.

On June 20, 1st ID relinquished TFF leadership to the 1st Armored Division. BG Randal Tieszen, U.S. Army, took command. The transfer of authority was shortly followed by a new series of civil disturbances. On June 23, approximately 800 Serbs attacked and vandalized the UNMIK office at Strpce. They were angry at KFOR's failure to locate an elderly man missing from the mountain village Susice. At the end of June, there were demonstrations and riots in Kamenica, a grenade detonated at a Serbian home in Cernica, and an explosion destroyed a Serbian Orthodox Church in Podgoce. In response, sanctions were placed on Serbians in Strpce and Albanians in Kamenica.

BG Tieszen remained in Kosovo less than two months. BG Dennis Hardy, U.S. Army, took command of TFF at the end of July 2000.

CHAPTER XVI

The Kosovo Environment

Larry Wentz

Land of Contrasts

Kosovo was a land of contrasts in terms of freedom of movement, social customs, politics and religion, views of the future, and modes of transportation. Albanians enjoyed a freedom of movement they had not experienced in years, whereas Serbs, who used to have important jobs and were free to move anywhere in the country, now lived as prisoners in their own villages. Country people lived much as their ancestors did centuries ago, working small farms by hand and living in homes made of mud and stone without running water. In the cities, people showed a higher level of sophistication, especially youths. Many traveled and lived in other countries, were exposed to foreign movies and television, and enjoyed western-style dress and modern conveniences. Young women dressed very well, albeit in a sexy style, with long flowing hair. Tight clothes were popular among both young men and women. They were a handsome and attractive people. The older generation, and those in rural areas where TV and movies had not created a new sense of style, still dressed in more traditional clothing. Many women were overweight and wore long skirts with aprons and kerchiefs. In contrast, the men were usually thinner and dressed in wool pants with black jackets. Many of the Albanian men wore the traditional Muslim skullcap. The younger men did not wear them.

The contrasts extended to almost every part of society. Transportation ranged from horse drawn carts to cars. Some restaurants served traditional foods while others offered western meals such as hamburgers. Cafes served juice, Turkish coffee, Makiato, and cappuccino. Markets provided produce and livestock as well as electronics and western clothing.

The Violence Continues

After nearly a year of KFOR presence, the country was still very dangerous. There were constant reminders that Kosovo was still a war zone. KFOR convoys and armored vehicles were on every road, and soldiers could be seen guarding checkpoints and churches, or patrolling the villages and countryside. All soldiers in MNB(E) wore flack vests and Kevlar helmets and carried automatic weapons. This was not necessarily the case in other sectors where soldiers, such as those from the UK, did not always wear flack vests and Kevlar helmets while on street patrol.

Although things appeared to be better in the Albanian dominated areas, Kosovo was still a relatively dangerous place and caution needed be exercised daily. Multiple shadow organizations formed to fill power vacuums and began to exercise control through actions such as illegal taxation. Organized crime was well entrenched and active in prostitution, drugs, and the slave trade. Public safety and rule of law, or the lack thereof, was still a problem and even cattle rustling plagued Kosovo. Land mines continued to be a danger everywhere despite KFOR and UNMIK efforts to clear them.

Not all Kosovars enjoyed freedom of movement, a feeling of security, or prosperity, despite the progress that had been made. People in the Serbian enclaves continued to be prisoners in their own country. Romas were mistreated and many lived in crowded refugee camps. Violent incidents continued. Grenades were thrown into groups of Serbian vendors. Crowds of Serbs were shot at with AK-47s. Such incidents killed or seriously injured Serbs and retribution actions were taken—primarily against innocent Albanian civilians.

The majority of the educated and experienced civil servants in Kosovo before the war were Serbs who fled as the bombing started, and never returned. Much of the Albanian leadership went underground or left Kosovo after Milosevic's speech at the Field of Blackbirds in Kosovo Polje in 1989. Many believe this speech ignited the current Balkan war. Those that stayed formed a shadow government to help the Albanian majority that was openly discriminated against during this period. Those Albanians that left Kosovo provided hard currency and resources from the U.S. and western Europe, as well as fueled the desire to break away from the Serbian government. As a result, numerous leaders emerged

in the Albanian sector, each with their own power base. Some centered on clan relationships, some developed around the UCK and war experiences, and others centered on economic relationships. It was impossible to tell who spoke for the Albanian majority because of this fragmentation in their society. One thing that was clear, however, was the Albanian position on Kosovo—to support the international presence because it provided the resources for the continuing efforts towards independence. The Serbian position was equally clear—to oppose Kosovar independence and denounce the international presence as a base of support for Kosovar independence. As long as the fundamental question of Kosovo's status remained undecided, there would be at best a complete freeze on Albanian and Serbian political interaction; and at worst, a continuation of violence. Since the Kosovar Albanians continued to see the Serbian minority as an obstruction to their goal of complete freedom, it was thought by many that any success achieved in maintaining a safe and secure environment for the Serbs would likely be short lived.

The roots of hatred run deep. The centuries-old animosity between the Serbs and Albanians that incited the ethnic cleansing during the war was still apparent. During the war, Serbs burned Albanian homes, but in the aftermath, the Albanians revisited those crimes upon the Serbs tenfold. Returning Albanians claimed (without authority) abandoned Serbian homes and property by painting their names on the buildings. Former Serbian property was confiscated and houses were being built on those properties. Without a civil administration there were no laws for the protection of property or codes of building construction. Most records of ownership also disappeared. Albanian and Serbian children were still taught to hate one another. Serbian children would be seen flashing the VJ (Yugoslavian Army) victory sign with their forefingers and thumb (Figure 1) at KFOR soldiers.



Figure 1. Serb Children

Before the war, there were parallel, but unequal, health and education systems in Kosovo. Serbian doctors were better trained and worked in hospitals and clinics, which provided services to all ethnic groups. Albanian doctors were forced to work in second-class facilities. After the war began, many Serbian doctors fled to Serbia and never returned. As result, there was a shortage of medical professionals. Those Serbian doctors who remained in Kosovo were victims of shootings outside the hospitals, so they would not venture out into the countryside to treat villagers in remote locations. Many people in rural areas were left completely without medical care of any kind. Efforts by the international community to encourage the Serbian doctors to treat these people failed.

Many Albanian houses flew the flag of Albania. This apparently served two purposes. It demonstrated patriotism and informed zealots that the house was Albanian and should not be burned down or claimed. Young Albanians frequently hung a large Albanian flag attached to a pole out of the car window and drove at high speeds through Serbian villages to intimidate them. There were UCK monuments erected within sight of Serbian enclaves. Such a monument (Figure 2) was erected at the multi-

ethnic market area of Kamenica and faced the Serbian enclave that bordered the market. Patriotism also led to the changes in the identity of many towns. On the main roads, signs for villages and towns that were spelled in both Serbian and Albanian had slashes of paint blocking out the Serbian spellings. Towns with Serbian names were given Albanian names. Ironically, the scene was reminiscent of Brussels, Belgium (the home of NATO headquarters) and the surrounding area where signs can be found in French and Flemish. In the French areas the Flemish will be crossed out and vice versa. Silent support of the UCK continued in Kosovo. Roadside cigarette vendors and shop owners used the Lucky Strike cigarette carton as a symbol of support. The Lucky Strike logo from a distance looks like the UCK symbol. These cartons were displayed in shop windows and kiosks (Figure 3). Roadside vendors also sold UCK patches and flags and UCK pendants hung from the visor of car owners who were supporters.



Figure 2. UCK Monument in Kamenica



Figure 3. Lucky Strike Carton

During the air war, NATO was dedicated to freeing the Albanians from Serbian ethnic cleansing. Now the efforts of NATO and KFOR shifted to protecting the minority Serbian population. KFOR soldiers guarded the entrances and exits to many Serbian towns. Tanks and barbed wire fences stood in front of Serbian Orthodox churches. KFOR soldiers escorted Serbian children to and from school. They also escorted Serbian convoys (Figure 4) back to Serbia, or elsewhere for medical treatment and shopping. These efforts required huge expenditures of time and money. Without them, though, even more Serbs probably would have been killed.



Figure 4. KFOR Serbian Convoy Escort

Early TFF efforts focused on monitoring and verifying withdrawal of VJ/MUP (Ministry of Interior Police) forces in accordance with the Military Technical Agreement. Later they monitored the demilitarization and transformation of the Kosovo Liberation Army (KLA). The withdrawal of the VJ/MUP forces was successful. The next challenge facing TFF was the KLA, which attempted to establish itself as a viable military force. In a major incident, the Marines had to capture and disarm a heavily armed company of KLA soldiers (116 men and women). The eventual transformation of the KLA into a civilian emergency organization, the Kosovo Protection Corps (KPC), was considered one of the major KFOR and UNMIK successes. Nightly explosions and routine exchanges of gunfire with unidentified hostile forces were the norm during the summer of 1999. KFOR was establishing a safe and secure environment while simultaneously establishing law and order, providing emergency humanitarian assistance, and supporting UNMIK and other agencies' efforts to help prepare the Kosovo residents and returning refugees for the coming winter.

The countryside where Serbs had coexisted peacefully with their Albanian neighbors for years seemed quiet enough, but hostile ethnic Albanian communities generally surrounded the Serbian villages or enclaves within an Albanian village. It was easy to identify the Serbian villages and homes by the KFOR soldiers who guarded them. It was

unsafe for Serbs to go far beyond the boundaries of their enclaves and villages. Attempts to travel to cities such as Gnjilane to shop or for medical care could result in being beaten, robbed or possibly even killed. U.S. MEDCAPs frequented the Serbian enclaves and villages, such as the town of Kmetovce near Gnjilane (which was half Serbian and half Albanian) to bring medical assistance to them. The major medical problems seemed to be lower backaches, diabetes, high blood pressure and arthritis.

A rare example of a somewhat peaceful coexistence was Kamenica, where Serbs and Romas lived in enclaves in a town dominated by Albanians, but mixed on the streets in town. Every Friday they congregated at the local market where each ethnic group had its own section of the market area, the largest belonging to the Albanians. Living in fear was not restricted to Serbs. In the MNB(E) sector a number of Albanian villages, such as, Bilince and Lovce, were located in the mountains along the Serbian border and the villagers lived in constant fear. Serbian atrocities had been committed there during the war and these villagers lived in fear of returning VJ and MUP. While accompanying a tactical PSYOP team visit to Bilince, several of the villagers expressed great concern to us about this. Although they felt safe and secure with KFOR protecting them, they said they would leave if KFOR left. The villagers explained that when the Serbian families had left the village, they had taken revenge and burned the homes they had vacated.

Drive-by shootings of Serbs were on the rise in the MNB(E) sector. Kosovar Albanian intimidation of Serbian communities and the destruction of Serbian churches were becoming more frequent. Sometimes these shootings and church bombings took place within sight of the protecting KFOR troops. The Serbian propaganda machine worked overtime to discredit UNMIK and KFOR. They were challenging the validity of UNSCR 1244 after the first year. They were promoting the return of the VJ and MUP to Kosovo to protect the Kosovar Serbs. From Serbia's point of view, KFOR could no longer guarantee protection. There were also heightened concerns about activities in the Presevo valley that bordered the U.S. sector and Serbia. The possibility existed that former UCK/KLA (the UCPMB) and Serbian forces (VJ and MUP) would begin fighting again. Organized crime, insurgency, and smuggling activities on MNB(E) borders were on the rise as well. This was a dangerous, but exciting time to be in Kosovo.

The Landscape of Kosovo

To some, the general impression of the Balkans was of images of wretched refugees, bombed out buildings, and ethnic violence. There were also perceptions by some that U.S. forces lived in luxury in garrisons such as Camps Bondsteel and Montieth and only went out during the daytime hours in heavily protected convoys. These are, after all, typical of the images portrayed by the media in print and on television. There was a wealth of stories of ethnic hatred that I read and heard about but did not fully appreciate until I witnessed it firsthand. The damage from the initial war and the resulting backlash was evident all over the country.

Scenes of destruction and desolation were everywhere. Paramilitary forces were still operating. Minefields, destroyed equipment, and burned-out homes cluttered the landscape. The initial NATO and U.S. planning did not adequately anticipate the enormity of the operation. Simply entering the country proved difficult. Further complicating the situation was the fact that the main supply route was also the only safe route for all local traffic and the “stay-in-place” refugee campaign had not worked. There was a massive flood of refugees returning to Kosovo earlier than expected. As a result, returning Albanian refugees crowded the roads along with KFOR, U.N., contractor, and humanitarian assistance vehicles. Some contractors were already in Kosovo and met KFOR soldiers as they crossed the border.

The local civil government was dysfunctional, so the civil administration duties of the police and firefighters had to be temporarily assumed by the military. The military also confronted criminal elements. The VJ/MUP were not defeated on the battlefield so it was not clear whether they intended to comply fully with the MTA. The departing VJ and MUP forces were accompanied by fleeing Kosovar Serb civilians (a new wave of ethnic cleansing) and followed closely by arriving KFOR ground forces. This was done to forestall a power vacuum in the cities and countryside where attacks and reprisals by Kosovar Serbs and Albanians needed to be kept in check. The threat of KFOR military force kept the situation from getting out of hand.

The justice system was in disarray at the outset, but after a year UNMIK had begun to make some progress by hiring Albanian (and a few Serbian) judges and prosecutors. The international community started to help

fund the re-establishment of a functioning judicial system, including court buildings, penal facilities and equipment. There continued to be one major problem in spite of these efforts: the perception that Albanian judicial personnel were subjected to outside pressures and would administer the law in a biased fashion against other ethnic groups. The introduction of the international judges and prosecutors was UNMIK's attempt to address these fears and eliminate partial rulings. Without a functioning and impartial legal system, nobody feared accountability. Individuals arrested and taken into custody by UNMIK or KFOR were often released after several days because the legal system couldn't process them. As a result, criminals, including those who committed murder, were walking in and out of detention facilities, such as the one on Camp Bondsteel in MNB(E).

Although KFOR was attempting to reduce crime and violence, they could not serve as a civilian police force. UNMIK was responsible for providing a civilian police force, however they were short-staffed and faced many difficulties in acquiring the personnel they needed. Recruits for UNMIK Police positions came from candidate nominations by countries around the world, however, in spite of clearly stated qualification requirements by UNMIK, many of the candidates were not qualified or prepared for the job. Some recruits were unable to speak English; others could not drive. The UNMIK police force was poorly supplied and carried inferior weapons to those of the criminals and gangs, which had grenades and automatic weapons.

Driving in Kosovo was a nightmare. People were more likely to be injured or killed on the road than by a sniper or act of violence. The roads were in terrible shape. Drivers would swerve to avoid potholes without worrying about oncoming traffic. UNMIK and KFOR were making road repairs but this had the unintended consequence of enabling drivers to travel at more dangerous speeds. There were no driving tests or licenses; most cars did not have license plates and drivers ignored internationally accepted rules of the road. Many UNMIK, OSCE, KFOR and international aid workers adopted Kosovo driving habits as well, adding more chaos to the highways with tanks, trucks and buses, Humvees, Jeeps, and Land Cruisers.

Traditional souvenir stands lined the roads where flags and patches of the KLA, UCK and UCPMP, music CDs, DVDs, cigarettes, and local folk art could be purchased. In fact, some of the major cottage industries of

the area were CD/DVD stores and cigarette stands along the roads and sidewalk such as those found lining the streets in cities like Pristina and Gnjilane. U.S. soldiers were not allowed to purchase such items while outside of the base camps. Other local cottage industries that sprouted up were cafés, car washes and gas stations. They were everywhere in large numbers. Some cafés were nothing more than an umbrella and a plastic table and chairs, while others had a more traditional European sidewalk arrangement. The car wash could be as simple as a flat area along the side of the road with a sign and a portable power washer connected to a power and water source. Many felt that the gas stations were most likely fronts for organized crime elements. Most gas stations were new and quite modern. There were more than 10 stations on a less than 30 km stretch of road between Urosevac (MNB(E)/TFF headquarters) and Pristina (KFOR and UNMIK headquarters) and several more were under construction in June of 2000. The limited traffic along this route hardly justified the number of stations being constructed.

Land mines and unexploded ordnance (UXO) continued to be a danger everywhere in spite of UNMIK and KFOR efforts to mark and clear mine fields (Figure 5). The danger increased significantly with the arrival of the spring and summer months. Farmers ventured into their fields and herders took their animals into areas not grazed upon since the war. Children played in potentially dangerous places. Many of these people and their livestock became victims. Farmers who found mines in their fields dug them up and place them along the roadside for KFOR troops to collect. Most mines detonated when stepped on and incidents of children and others being killed were commonplace. Children were seen playing with unexploded munitions such as cluster bombs and in one incident, a child was killed and another seriously injured when the cluster bomb they were playing with exploded. On the other hand, vineyards in the mountains went unattended and were not watered because the owners were afraid to venture into the fields. KFOR soldiers were constantly reminded not to go off the main roads and mine awareness was a major KFOR information campaign subject. UNMIK and KFOR mine awareness posters could be seen everywhere, as well as displays of deactivated mines (Figure 6).



Figure 5. Cluster Bombs



Figure 6. U.N. Mine Awareness Display

One shock was the extent of the trash that littered the roadsides and streets of populated areas. As the German soldiers told me jokingly during a visit to MNB(S) headquarters in Prizern, “It’s plastic to the left, garbage to the right and metal on top.” The debris of war littered the

countryside, villages, and cities of Kosovo. Although not quite as pervasive as in Bosnia, there were still numerous bombed out factories, government buildings, businesses, and homes. Gutted vehicles and land mines were everywhere. The region's ancient power plant failed daily and water failures (electric pumps) were experienced in the major cities of Pristina, Urosevac, and Gnjilane. Although sanitation services such as garbage collection were restarted before my visit, piles of garbage continued to be seen everywhere. Air pollution was high, mainly from car exhaust fumes. Without a functioning government, there were no means to enforce things such as sanitation and pollution controls.

Kosovo was a beautiful country that had been ravaged by war. The mountain villages were collections of tiny houses with red tiled roofs, which probably looked just as they had centuries ago. Most homes had no indoor plumbing, necessitating outhouses near every home. Water was obtained from springs and wells, however the departing Serbians had fouled many wells by throwing animal carcasses into the water. Villages that relied on streams suffered the pollution effects of rusting cars, dead animals, and general refuse.

There were roaming packs of stray dogs, abandoned by owners whose homes had been destroyed during or after the war, which became a problem—hungry and fighting for food, attacks on humans increased, as did the danger of rabies. U.S. civil affairs, in conjunction with the TFF veterinarian, ordered cages from local vendors and after obtaining medications, the cages were baited to lure the wild animals. Local veterinarians, trained by the TFF vet, euthanized the dogs and properly disposed of the carcasses, thus helping to relieve the problem.

In the countryside and villages, almost every yard included a barn for the family's animals. Solitary shepherds tended small flocks of sheep, goats and cows. They followed behind as the animals grazed the unfenced mountainside pastures. Their only companion was usually a dog. Typically children and old men performed this task but occasionally I saw a woman tending a single cow. I also saw old men with one or two cows grazing along the major roadsides.

The Kosovar women cooked, cleaned and raised babies. They washed the family's clothes by hand. They also helped the men weed the crops. It was not unusual to see women in the fields from early morning until the evening. I saw the men cutting the grass by hand and drying it in stacks for hay to feed their animals in the coming winter. A tiny field

that would take minutes or hours to cut with modern farm equipment would take days to scythe by hand. I frequently saw people working the crops by hand and using horses and cattle to pull plows and wagons. This was attributed mainly to the fact that many of the farmers lost their tractors and other equipment to the Serbs as spoils of war, or they were stolen or destroyed.

All over Kosovo, children seemed to be enchanted with the American soldier. They followed the U.S. soldiers everywhere in the towns and villages. If a helicopter flew over they would run to the highest point in the village and wave. As Humvees drove along the roads, children of all ages would run out. Groups of children along the roads would wave and frequently try to give the passing soldiers “high fives,” a practice that was quite dangerous. Sometimes the soldiers would throw candy to the children as they passed and there would be a scramble to pick it up, sometimes extremely close to the passing military vehicles. The fascination was even greater in smaller villages. There were usually few people around upon arrival in a small village, but within minutes children swarmed out and surrounded the Humvees. They would pester the soldiers, many times tugging at the weapons they were carrying. A tragic incident occurred in a schoolyard in Vitina when a child was killed while he tugged at a KFOR soldier’s weapon. The children were eager to practice their limited English. Often they would shout, “Hello.” The soldiers would answer with, “Miredita” (Albanian for “Good Day”). Carrying a camera was also a sure way to attract the children. They loved to have their pictures taken (Figure 7). Children in the villages would swarm around the combat camera soldiers, posing for pictures, and just acting curious about the sophisticated camera equipment they used (Figure 8). Often the PSYOP and civil affairs soldiers would take pictures of the kids and then take copies back to them a few days or weeks later. The kids would carry the pictures around with them and show them to the soldiers when they returned to the village.



Figure 7. Children of Kosovo



Figure 8. Combat Camera

Schools were back in session and I saw the young Albanian children walking along the streets to and from school. They had not been able to attend school freely under Serbian rule, and many Albanian school classes had been held in over-crowded private homes, warehouses, basements and mosques. During the Serbian reign, the makeshift school facilities lacked proper teaching equipment (some painted black rectangles on the wall to serve as a chalkboard) and textbooks.

After the liberation, Albanian teenagers could be seen hanging around the centers of the towns and villages where there were market areas, cafés or grocery stores. In contrast, Serbian children were escorted to and from school by KFOR soldiers and stayed at home when not in school. In Serbian enclaves, children could be seen playing. Many of the Serbian children were taught in homes and storefront schools in the Serbian enclaves. Others attended public schools that were shared between Albanian and Serbian students, one ethnic group using the school in the morning and the other in the afternoon. The inside of a schoolhouse was very basic—several small classrooms, battered tables and chairs, and wood stoves (Figure 9). There were no computers and many rooms didn't even have a blackboard. In some school classrooms and halls there were pictures of a UCK hero, others had cartoon murals painted on some walls, and still others simply had dull green, cream or gray walls in dire need of being repainted. The floors were wooden, and they too were in need of repair.



Figure 9. Typical School Room

A Unique History and Culture

There were a number of historic and religious sites in Kosovo that, unfortunately, many U.S. soldiers did not get the opportunity to see or visit. One important religious site in MNB(E) sector was the historic church in the village of Letnica where Mother Teresa found her calling. Another historic site that many KFOR soldiers saw from afar while driving along the main highway in Polje, was the ancient battlefield referred to as the “Field of Blackbirds” near Pristina. Both sites were worth a visit. Fortunately during my visit I was able to see both. The following discussion of these two sites of interest was derived in part from SGT Martinez’s article on the “Madonna of the Black Mountain” in Task Force Falcon’s newsletter *Falcon Flier*. It reported on a visit by the U.S. 142nd Engineers and CPT Monika Bilka’s article on “The Monument” in NATO’s newsletter *KFOR Online* and *Letter from Kosovo* by SFC Jonathan Crane, U.S. Air Force, TFF public affairs office.



Figure 10. The Black Madonna

The church in the village of Letnica, Kosovo contains the Madonna of the Black Mountains. This church is unique for two reasons. First, it is

one of only a few churches in the world to have a black Madonna on the altar (Figure 10). Second, it was the church where Mother Teresa found her calling. The plain white church with twin steeples sat on top of a small hill near the center of the village and could be seen in the distance as we approached Letnica. The village itself was almost a ghost town and there were only a few people to be seen. At the base of the hill there was a traffic circle that looked like it had served as a parking lot for the church in the past. There was also a bus stop and kiosk but they did not look like they were used anymore. It was a short walk from the rusting bus stop up a steep cobblestone path to the church. Approaching the church, I could tell that it was different. Most of the religious shrines in war torn Kosovo had KFOR guards protecting the Christian and Moslem places of worship because of ethnic strife. Oddly, the church in Letnica had no guards. During the conflict in Kosovo, the Catholic Serbians and the Muslim Albanians both respected the church known as Gospa Letnika, the Madonna of the Black Mountains, as a holy place and inflicted no damage on the church or its surroundings.

The interior of the church was striking and the religious artistry of the temple was awe-inspiring. The black Madonna was significant because the Madonna seldom commands the altar. A crucifix dominates the altar in most Catholic churches. While this church had crucifixes in it, a statue of the Virgin Mary holding the Baby Jesus stood above the altar. Another significant difference was the color of the statue. When entering a Catholic church in the United States, all the icons of Jesus, Mary, and the saints are white. The church in Letnica, where all the parishioners were white, had a black Madonna. Mother Teresa was born there and after leaving the village she would come back to visit. It was on one of these visits that she felt her calling into the ministry of Christ.



Figure 11. Field of Blackbirds Monument

*Those who are Serbian and have a Serbian heart
and do not come to battle for Kosovo will not
have children, neither male nor female, crops or
wine. They will be damned until they die.*

These words, taken from the ancient stone walls of the monument close to Pristina, captured the continual conflict between Serbs and Kosovar Albanians (Figure 11). Some 600 years ago on the high plains of northern Kosovo two armies met, Serbian and Turkish. Only one army survived. The defeated lay where they fell, to be consumed by crows, and the place became known as the “Field of Blackbirds.” The historic battle about 600 years ago reminds us of the crucial significance of the KFOR presence today.

The first glance into the hall of the monument from the squeaking door revealed damage due to some sort of explosion. The first steps were missing and the rusty steel construction was exposed. Some sandbags functioned as the lowest steps. I carefully crossed the floor to the stairs. The steel railing beside the narrow staircase was hardly ever to

be trusted. On my cautious way up, close against the gray spotted stone wall, heavy plates with Serbian inscriptions caught my eye as they appeared from the darkness. Deep, narrow windows from the opposite walls provided just enough light to read the plates, but they were written in Cyrillic. The Norwegian soldiers guarding the monument provided a placard to visiting KFOR soldiers to read that had English translations of the inscriptions. A spectacular view of the countryside appeared before me as I emerged from the darkened staircase and approached the tall stone wall surrounding the top of the monument. The view became even more spectacular as the sun set over Kosovo Polje and the wind howled around the monument. As the day turned into night, the red sky illuminated the inscription plate telling the story about the historic battle in 1389, when 135,000 soldiers met on this very battlefield to fight for Kosovo. The fight was not yet over.

A Slow Return to Peace

The commander of KFOR (COMKFOR), German General Klaus Reinhardt, in an end of tour article for the summer 2000 edition of the *NATO Review*, stated, “Today, many Kosovars have returned to their homes. The streets of Pristina are filled with buses and cars, and crowded with people who feel safe to go out. Bars, restaurants, and shops have reopened and markets and street stalls are thriving in many areas. Newspaper stands carry uncensored local newspapers, as well as international publications. Radio stations are free to broadcast what people want to hear. Many Kosovars are enjoying freedoms denied them for years.” Pristina was, however, still a city with a split personality: chic teenagers flirted on the sidewalks while younger children roller-bladed in the central plaza. However, barely a day went by without news of another shooting, an ethnic flare-up, or a political crisis. COMKFOR also acknowledged that it was KFOR’s continuing responsibility to maintain a safe environment in which all the communities of Kosovo—the Serbian, Bosnian, Roma, and Turkish minorities, as well as the Albanians—could begin to rebuild their lives.

UNMIK had a less optimistic view of the security situation. They reminded everyone of the security reality in their year-end report to the U.N. Secretary General. The document noted that the general security situation in Kosovo had not changed significantly. Members of minority communities continued to be victims of intimidation, assaults and threats

throughout Kosovo. In particular, UNMIK felt the upsurge in localized violence, where the attacks had been almost exclusively against Kosovar Serbs. UNMIK police crime analysts estimated that about two-thirds of the serious crimes committed were inter-ethnic and directed mostly against Kosovar Serbs. Eighty percent of the arson cases were identifiable as ethnic crimes. Metrovica continued to be a flash point for ethnic violence. In spite of continued violence against the Serbian minority and a general lack of proactive international leadership, resources and funding, steady progress was made by UNMIK and KFOR to tame the Kosovo crisis. The challenge for the future would be to summon international wisdom and political will to stay the course. This meant making the necessary resources and funding available to restore freedom, public safety, and rule of law.

In spite of the renewal of some transportation services, the opening of some shops, and the appearance of people going to work every day, unemployment was over 90 percent. From discussions with local Albanians, I learned that most of their money came from relatives and family members working in the United States and western Europe who sent money back to family members in Kosovo. The absence of a functioning economy and transportation system meant that almost everything had to be shipped in by truck. This was very visible at the Blace border crossing between the Former Yugoslav Republic of Macedonia and Kosovo where trucks could be seen lined up for miles in both directions waiting for hours and sometimes days to cross the border.

The Americans were quite popular with the Albanians. Graffiti was a popular way of expressing Albanian patriotic fervor. KFOR-USA, NATO, "THANK YOU AMERICA," U.S. ARMY, and U.S. MARINES were common on walls as well as "USA-KLA." Pictures of President Clinton and Secretary of State Albright were said to hang in some Albanian homes. Posters with President Clinton, Ambassador Walker (Kosovo Verification Mission) and General Clark (Supreme Allied Commander Europe) were pasted on walls and buildings in Gnjilane in preparation for a locally sponsored KFOR anniversary celebration held in June. American KFOR soldiers were greeted with a thumbs-up.

Other KFOR contingents were not as highly regarded as the Americans. Russians were hated the most, followed closely by the French. The Russians and French were given extremely challenging KFOR assignments in light of their poor public relations. The Russians

guarded road crossings on the frontier with Serbia and the French were tasked with maintaining law and order in the ethnically divided city of Mitrovica. The U.S. and British were also given challenging assignments in that their sectors contained the largest population of Serbs in a mixed Albanian and Serbian environment—there was no *de facto* partitioning as was the case in Bosnia. With movement around Kosovo under tight KFOR control, fake ID cards, uniforms, and markings on vehicles became more common as dissidents on both sides tried to work their way around the countryside. Sightings of persons dressed in VJ and MUP uniforms near Albanian villages were reported, as well as persons dressed in UCK/KLA uniforms near remote Serbian villages. There were both Serbian and Albanian kidnappings and killing of shepherds and others, usually old men, in the mountainous areas.

The 4,000 UNMIK police were not enough to address the needs of nearly 2 million civilians. There was also a need to focus on local policing that could deal more effectively with hate crimes and local needs. UNMIK created and started to recruit, train, and staff a local police force, the Kosovo Police Service (KPS). The process moved slowly and lacked sufficient resources, but about a third of the planned 4,000-man local police force was on the streets working with UNMIK police.

In spite of many problems, the efforts of the international community seemed to be effective and living conditions were generally improving. New homes were being built and damaged ones repaired. The power plant, telecommunications and water services were being repaired, food supplies were showing more variety, and restaurants were opening. Even Coca-Cola and ice cream could be purchased from local kiosks, stores and roadside stands. It should not be forgotten that most of the people of Kosovo were friendly, both Albanian and Serbian, even though some Serbian villagers continued to give hostile stares. Troublemakers were a minority.

CHAPTER XVII

Peacekeeper Quality of Life

Larry Wentz

Camp Bondsteel

Early on, senior U.S. Department of Defense (DoD) and Army leadership began to consider improving the quality of life of U.S. peacekeepers in Kosovo. In contrast to the Bosnia peacekeeping mission where troops lived in tents for many months before moving into hardened structures, the DoD and U.S. Army decided to erect three base camps from the start. The U.S. Army built two base camps in Kosovo and one in the Former Yugoslav Republic of Macedonia. In Kosovo, the 9th Engineer Battalion, working with contractor Brown and Root, was charged with building two base camps for a total of 7,000 troops by October 1, 1999—ensure that housing was built for soldiers before the winter set in.

At the height of the operation, there were about 1,000 expatriates hired by Brown and Root along with more than 7,000 Albanian local nationals and about 1,700 military engineers. From July through October, construction at both camps continued around the clock. A major obstacle was the discovery of a 36-inch natural-gas pipeline under Camp Bondsteel—it was easier to redesign the camp around the pipeline than to dig it up. More than 17 km of fence (10 km around the perimeter of Bondsteel alone) was constructed. Lumber for the SEAhuts came mainly from Austria. The construction required a quarter-million 2x4s, almost 200 tons of nails, and more than 100 miles of electrical cable. Some half-million cubic yards of earth were moved on Bondsteel alone and the battalion reconnoitered more than 320 kilometers of roads. In less than ninety days, more than 700,000 cubic feet of living space had been built—equal to a subdivision of some 355 houses.

The “Grand Dame,” Camp Bondsteel (Figure 1) was the home of headquarters Task Force Falcon of Multinational Brigade East near Urosevac. Establishment of Camp Bondsteel sent a strong signal to the factions and local populace that KFOR, MNB(E), and the U.S. were planning to stay. The second largest camp, also an engineering marvel, was Camp Montieth (Figure 2), located on what used to be a VJ military base near Gnjilane. The U.S. camps were named after Medal of Honor recipients, Army SSG James L. Bondsteel, honored for heroism in Vietnam, and Army 1LT Jimmie W. Montieth, honored for heroism in France during World War II. The third base, Camp Able Sentry (CAS) served as the Intermediate Staging Base (ISB) for Receiving, Staging and Onward Moving (RSO) U.S. forces and the entry point for all support supplies and equipment bound for KFOR. CAS was collocated with the Skopje civilian airport in the Former Yugoslav Republic of Macedonia. In spite of the large base camps, roughly 3,000 of the more than 9,000 soldiers of MNB(E) lived in forty satellite camps within the 2,300 square kilometer American zone. Buildings such as factories, hotels and old government buildings typically served to house the tactical operations centers and soldier living quarters at the satellite camps. Some soldiers at remote outposts, such as Sapper, lived in tents.



Figure 1. Camp Bondsteel



Figure 2. Camp Montieth

Camp Montieth was an old Yugoslav Army barracks that was still largely intact after the war. However, either retreating forces or locals had damaged and looted the buildings so it took several weeks to make them usable again. For force protection reasons, many of the original buildings were abandoned and most of the camp was built in an adjoining field. More than 75 Southeast Asia huts (SEAhuts), along with support structures, were built to accommodate about 2,000 troops.

Camp Bondsteel was considered to be the largest base camp construction effort since Vietnam. Set atop high ground that escaped the fog, the massive Army-built camp sprawled across 1,000 acres of wheat fields. Rows SEAhuts appeared at Camp Bondsteel, and Camp Montieth. The SEAhuts (Figure 3) were single-story wooden structures that were first used in southeast Asia and more recently in Bosnia. The military redesigned the SEAhuts specifically for Kosovo. Each wooden structure had the ability to accommodate a male and female latrine (toilet, shower and hot and cold water) and up to five rooms (16 by 32—the size of a medium, general purpose tent) housing up to six service members each or 30 soldiers per SEAhut. Where possible, men and women were housed in separate SEAhuts. The rooms had a small window, emergency lighting, smoke detectors, electrical outlets, heat,

air conditioning, telephones, beds, storage cabinets, and refrigerators. For entertainment, soldiers brought their own CD players, radios, TVs, VCRs and even satellite TV. The SEAhuts had aluminum roofs, plain white painted interior walls (plasterboard for fire resistance), simple plywood floors, and brown exterior walls. Interspersed among the SEAhuts were sandbag bunkers and HESCO force protection barriers separating the various offices and living areas.



Figure 3. SEAhuts

Due to the total absence of civilian sewage-treatment facilities in Kosovo, early efforts focused on building sewage lagoons and wastewater treatment plants in order to not foul the local watersheds. Wells were the primary source of water for Bondsteel and water was piped into the huts from huge holding bags filled from these wells. For drinking purposes, bottled water was provided and available everywhere throughout the camp. In fact, because of dehydration concerns during the summer months, ice packed coolers with bottled water and other drinks were part of the survival package taken along when traveling off base.

Following the initial construction phase, Camp Bondsteel continued to expand every day. When the sun came up over Bondsteel, the sounds of earthmovers and construction crews filled the air. During the day, a constant swarm of Apache and Black Hawk helicopters passed overhead. MEDEVAC helicopters were seen both day and night, mainly bringing local victims of landmine explosions, gunshot wounds and traffic accidents to the Bondsteel hospital. Columns of Humvees and

armored personnel carriers continuously churned through the dirt tracks that were the major roadways and streets of the camp. During dry periods this created many dust clouds, but when it rained the tracks quickly turned into rivers of mud. The dust and mud kept the local hire cleaning crews busy with daily cleanings of the SEAhuts and office areas. At the entrance to offices and SEAhuts there were water tubs and brushes for cleaning boots. The dust also created problems for the computer disk drives and keyboards.

At night it was quiet except for the helicopters setting off or returning from patrols or QRF actions. Sometimes the quiet of the evening was also broken by the sound of a visiting rock band entertaining the troops at the theater or a “Bright Star” demonstration (shooting off flares). The Explosive Ordnance Disposal (EOD) unit entertained themselves day and night by detonating confiscated munitions, and these detonations sent shock waves through the buildings.

On Bondsteel, there were more than 350 buildings including over 175 SEAhuts, a hospital, a detention facility, a Post Exchange (PX), a post office, a theater, chapels, fitness centers, two huge mess halls, drop off laundry service, a cappuccino and espresso bar, and even a Burger King. Contact with the outside world was available through daily *Stars and Stripes* newspapers, a local AFN radio station, and a TV in the mess hall that carried AFN TV news and American TV shows. Commercial TV satellite dishes were also seen spread throughout the SEAhut area. They could be purchased from the PX as well as all sorts of electronics, magazines, books, clothes, food, candy, personal hygiene items, writing materials, and other supplies. By the end of June, an athletic field was also under construction near the north dining facility. Camp Bondsteel made every attempt to provide the troops with a slice of Americana.

The dining facility (referred to as the DFAC), served over 20,000 meals a day for soldiers and a large number of civilian contractors. They were always open. Three major meals were served daily and in the off hours there was a counter that served both hot and cold meals and drinks. A variety of Meals Ready to Eat (MREs) were also available anytime of the day or night. Boxes of powdered and plain donuts were available for the taking and every morning after breakfast several staff would bring a box or two of donuts back to the G3 plans shop. Ice cream was also available any time of the day or night. There were two freezers, one

at each end of the DFAC so after a long day, soldiers could go to the dining hall and pick up a cone or Popsicle. Microwave popcorn was also available and although alcoholic beverages were not allowed there was an alcohol free beer, Buckler, which was available at the dining facility. Frequently, late in the evening Saturday night, the G3 plans shop would set up their own movie theater that consisted of playing a DVD movie on a laptop computer and projecting it on the wall of the plans shop.

The dining facilities were staffed by local hires and operated by the contractor Brown and Root who also provided other base services in support of Task Force Falcon. The DFAC food was judged some of the best food in Kosovo and was a major attraction for those living outside of Camp Bondsteel or visiting Kosovo. The AAFES-run PX had a good reputation as well. There was also a large motor pool, fuel storage bay, helicopter flight line, weather operations center, and ammunition holding area. Special Operation Command had its own fenced off and force protected compound on Bondsteel. SEAhuts accommodated offices and billeting areas for the MPs, public affairs, combat camera and their production facilities, civil affairs, and psychological operations (PSYOP) forces, including the PSYOP product development and production center. These base camps functioned as cities, employing a mayor and support elements dedicated to the management of the base itself.

The tactical operations center (TOC) and MNB(E) headquarters offices were located on a hill overlooking all of Bondsteel. The Ops Center stood next to a wooden superstructure supporting satellite dishes and antennas. Fencing and force protection barriers, as well as armed guards, protected the complex. This area also housed various intelligence offices and their support elements. The TOC and intelligence complex were active 24 hours a day.

Almost every corner of Bondsteel was brightly lit with orange streetlights. Stadium lights pointed outward, starkly illuminating the landscape for a few hundred yards beyond the guard towers and barbed-wire fences that surrounded the base. The guard towers were manned continuously by soldiers who pulled long and often boring shifts watching for anything out of the ordinary in their sector. The boredom was broken frequently by radio checks and visits by the sergeant of the guard.

Military guards armed with automatic weapons tightly controlled access to the base camps. These guards closely checked everyone's ID card and inspected every vehicle attempting to enter. Such inspections included opening vehicle doors and trunks, inspecting the interior, and the use of mirrors to search under the vehicles. The access roads had cement barriers organized in an obstacle course fashion to control traffic flow while other gates and barriers blocked unauthorized access. For local nationals working on base, there was a special access area where all were searched before entering (they were checked when they left as well).

Soldiers carried their weapons with them at all times, even to the dining facility. When outside the base, weapons were kept loaded and ready at all times. Upon re-entering the base, soldiers unloaded and cleared their weapons in the discharge area.

Quality of Life

Kosovo was not luxury living for the U.S. military. Over a third of the forces in MNB(E) lived off the major base camps. Camp Bondsteel served mainly as the MNB(E)/TFF headquarters and as the logistical and administrative support base for TFF. The quality of life on the large bases was certainly better than that experienced by the soldiers who lived off the major base camps, but life was still not up to the standards of their home bases in the U.S. and Germany, especially regarding freedom of movement off base. Soldiers on Camps Bondsteel and Montieth were restricted to the bases and not allowed to go into town or fraternize with the locals except for duty missions that required travel into the countryside. Even so, eating in local restaurants or purchasing things from the local shops were prohibited. Without a civil administration to enforce health and sanitation laws, eating and drinking in local establishments was a health hazard. There were concerns linking dairy products and hepatitis. Some U.S. soldiers spent their entire six-month assignment in Kosovo on base at Camp Bondsteel.

Special Forces teams lived in "safe houses" in towns where they were deployed. They were one of the few elements that were allowed to walk around without a flack vest and helmet and could also eat and drink at the cafés. The Polish contingent in Strpce occupied a ski chalet and the 1-187 Infantry soldiers covering the Vitina area occupied a factory near

Vitina. A platoon temporarily guarding the town of Letnica lived in the former nun quarters of a church. The “Eagles Nest,” which housed a platoon conducting anti-infiltration operations on the Serbian border, occupied a local stage theater (the Ops-Intel Center was the ticket booth). The U.S. communications and intelligence teams supporting the Russian 13th Tactical Group in Kamenica occupied some rooms in a local government building that were part of the Russian compound, and many of those manning outposts, such as Sapper which overlooked the Presevo valley, lived in tents. There were also small tent cities on Camp Bondsteel (Figure 4) and Camp Able Sentry that were used for temporary quarters for housing additional troops during the command transfers and unit rotations. Camp Montieth also erected large aluminum buildings that served as storage areas. The temporary billeting provided little privacy with wall-to-wall cots and personal belongings stored between them (Figure 5).



Figure 4. Camp Bondsteel



Figure 5. Camp Montieth

There was a need to consider ways to provide soldiers on Camps Bondsteel and Montieth with opportunities to go outside the wire under controlled conditions. Many of the soldiers in support positions on Bondsteel often went for weeks without leaving the base while others never left at all during their tour of duty. There was an escorted bus service that operated daily between Camp Bondsteel and Camp Montieth and this offered an opportunity for some soldiers to go off of the base and see a little of the countryside. There was a fighter management pass program initiated by V Corps and 1AD commander that offered a 4 day pass to Lake Ohrid in the Former Republic of Macedonia to give TFF members a well deserved break. There were some limited visits to historic sites but these were the exception and not part of an organized program of R&R activities.

Morale

There were generally three types of problems the commanders experienced with their troops while deployed. For the first one-third of the deployment, there were few discipline-related problems because the mission was new and exciting. The major source of problems during this phase was that troops missed their families. Other problems ranged from financial issues to children to loneliness. Most family problems got sorted out by in the second-third of the deployment, but problems

with older children or teenagers tended to resurface, driven by resentment at being asked to carry the responsibilities of the absent parent. Soldiers also tended to lose focus and become complacent even if they were in dangerous areas. They were performing the same duties over and over again. Typical of Americans, they wanted to see measurable progress and when they didn't see the progress they expected, their frustration increased. In the final third of the deployment, everyone wanted to go home and their families were anxious to see them. Although the soldiers were focused on the mission, there was a tendency to rush through things and safety became a major concern.

During a round table discussion conducted with the MNB(E) headquarters staff, the G1 stated he was experiencing a high re-enlistment rate. In Kosovo, re-enlistment bonuses were tax-free. On the other hand, the chaplain stated that he was experiencing one of the most severe morale problems he had ever encountered. The chaplain said he had soldiers lined up every day outside his office to speak to him. Apparently the problems were with the younger troops, some who volunteered or wanted to go to Kosovo as a way to save some money. For many of the young soldiers, this was their first separation from home. They and their loved ones were having problems dealing with the loneliness and handling family problems from afar. Interestingly, a contributing factor was the great military communications system that allowed daily e-mail and voice contact with family and loved ones. On the surface, it appeared to be a good thing for morale but it turned out that this was a key source of the problems of the young soldiers. It was discovered that 60 percent of the soldiers used e-mail daily and 20 percent several times a week. Issues that would have been normally sorted out at home or with the help of family support groups at the home station were being discussed daily via e-mail and the telephone. Small problems suddenly became big ones—an unintended consequence of Information Age communication.

A study of soldier morale conducted by Professor Charlie Moskos of Northwestern University in the fall of 2000 found that morale was substantially higher at the beginning of the tour than at the end. It was also higher for soldiers in the field such as the civil affairs, PSYOP, MPs, and maneuver units. The lowest morale was with the logistics and administration soldiers who were located on the major camps doing routine work. Also suffering low morale were those pulling stationary

guard duty. These were soldiers who had more idle time than those who went outside the camp every day.

Training

Although improvements were constantly being made to help better prepare new U.S. units for deployment to Kosovo, opportunities remained to improve training. Relevant in-country Operations-Intelligence databases and archives were maturing, but a lot of work was still required to improve the archiving processes and transfers to new units. Mission Rehearsal Exercises (MREs) were improving and were considered a good training vehicle for preparing the brigade and battalion levels for deployment. However, it was felt that the MREs needed to put more emphasis on exercising the field units—battalions, their companies, and platoons—and providing a more realistic depiction of the environment they would face on the ground, including cultural and social situation awareness. Combat support units such as PSYOP and civil affairs would benefit from participating in MREs as well.

There were no standard operating procedures established for conducting multinational operations. Therefore, the U.S. units employed new procedures to integrate the multinational commanders into their battle rhythm and treated them as subordinate commanders. Weekly coordination meetings were held with units where intelligence was exchanged and joint patrols were discussed. The meetings were rotated through the various headquarters of the TFF multinational units.

Battalions were asked to do their own Individual Readiness Training (IRT). The Combat Replacement Center (CRC) training was felt to be too Bosnia-oriented and not focused enough on Kosovo. This training implied that Bosnia and Kosovo were similar when in fact they were very different. The sharing of lessons from earlier Kosovo deployments was problematic. There was a need for a single point of contact to go to for information on Kosovo before deploying. Soldiers were interested in learning more about the country and its people and culture. The KFOR Handbook (DoD-2630-011-99, July 1999) was inadequate and out of date. It focused too much on military aspects and not enough on the nonmilitary things the soldiers needed to know in order to deal with the local religious and civil leaders. Increased leader reconnaissance activities provided more in-country hands-on visits. These visits served

to better prepare the incoming leaders by allowing them to see firsthand the terrain, people, and real-world problems they would have to deal with when they took command.

In spite of good soldier training, there was a need for additional training to prepare U.S. units for peace operations. Combat arms units were called upon to execute a set of tasks that were not normally associated with their Mission Essential Task List (METL). For example, tank crews in Kosovo dismounted and operated as infantry. MPs quickly found themselves becoming investigators. Although quite versed in MP procedures, many lacked the basic fundamentals of police investigation and time had to be taken to train them to ask the right questions at the right time, to protect and share “police information,” and to collect information from non-police elements. Crowd control and use of non-lethal weapons were important skills and assets that required additional training and equipment once in country. Urban combat techniques needed to be incorporated into pre-deployment training. Virtually every soldier that patrolled needed to be trained and drilled on room entry techniques, house clearance operations and other related combat activities. Civil-military operations (CMO) needed to be incorporated into the military training and education programs. Soldiers learned how to conduct town meetings and developed negotiation and conflict resolution skills on the ground after deployment. Information operations, a new concept for maneuver units, demanded new training and education.

Maneuver units coordinated their operations with MPs and UNMIK police, however there were still overlaps with them, as well as with civil affairs and civil-military operations activities. U.S. units also coordinated with the various multinational units in Kosovo, requiring adaptations to foreign tactics and procedures. They carried out joint patrols and coordination meetings and exchanged intelligence.

Young sergeants, E-5s and E-6s, interacted daily with all kinds of people and had to make quick decisions in the field, which had the potential for immense strategic political implications. The politics of Kosovo and actions on the ground went well beyond the geographic boundaries of the province, sometimes having global implications. This was the age of what was frequently referred to as the “Strategic Corporal.” It was, therefore, important to make sure that the young soldiers understood their commander’s intent because they played significant roles in executing it. The young soldiers participated in local leader

meetings to help get local people to come together and resolve conflicts between Albanians and Serbs. The techniques of negotiation and dealing with unfriendly people needed to be taught to the lowest operational levels within MNB(E). The majority of contact with the local population occurred at the platoon and squad level. The stress of these situations had the potential to drive soldiers into dehumanizing the population that they were trying to protect in order to make it easier to cope with, especially when the use of force was necessary. This required constant military leadership attention to make sure soldiers did not act simply as shepherds over a flock of animals. Resolving conflicts and issues, meeting and talking with the local population daily, and delivering messages to their target audiences without seeming overbearing or intrusive was clearly an art requiring a great deal of practice. At “the rubber meets the road” level, these skills were generally acquired while executing the military mission.

Young soldiers in their late teens and early twenties patrolled the streets of villages day and night and in all weather conditions. In the summertime, temperatures could exceed 100°F at mid-day and in full battle gear this was hot and tiring. Dehydration was a constant concern and soldiers were reminded to drink lots of water. Under these conditions, soldiers on patrol had to take breaks every couple of hours. In discussions with these young soldiers, none were heard to complain about the situation they were placed in. They simply did their job and did it well.

The transfer of authority and replacements in place (RIP) process had to be carefully managed. TFF staff had to be adapted to the new commander. In-coming and out-going officers met constantly to insure that the new staff fully understood their new duties. They underwent an eight-day transfer period. Four days were spent instructing the new staff, and four days were spent overseeing that they could successfully execute their duties. There were a number of officers that, for different reasons, only spent a few weeks or months in Kosovo, and therefore, the transfer of authority for them and their job was less satisfactory. The short duration of many of their the assignments required soldiers to learn on their feet, and many did not have the opportunity to go into the countryside to learn about the issues and the people. For example, the USAREUR LNO rotated about once a month and while I was at Camp Bondsteel, he only had a few opportunities to travel off base to see some forward deployed U.S. and multinational units and meet some

of the local people. His time was mainly spent working command level actions between U.S. Army Europe (USAREUR) and TFF.

In spite of the carefully managed transfer process, there was still a spooling up period after the new team assumed control of operations. Not only were they adapting to the environment, but they were also working with each other for the first time. Regardless of how well the transfer was executed, local belligerents carried out various attacks to test the new arrivals during its first weeks in Kosovo.

American Red Cross

The American Red Cross Armed Forces Emergency Services organization has a long history of providing service to America's soldiers in times of war and other conflicts such as the peacekeeping operations in the Balkans. Red Cross workers provided humanitarian assistance to U.S. service members by conducting emergency communication and social welfare activities. Canteen services, such as free coffee and donuts, reading material, movies, stationary for writing home, and toiletry items were provided as well. Beyond the canteen services, the primary mission of emergency communications made it an essential part of any military action. Red Cross emergency messages informed military members of illness or death of immediate family members as well as other family emergencies or events such as the birth of one of their children. Bill Wright, the Red Cross team leader for the MNB(E), noted that MNB(E) averaged about 30 emergency messages a week.

In a discussion with Camp Bondsteel Red Cross worker Ms O'Brien, she explained that the Red Cross in MNB(E) consisted of a team of five (three at Camp Bondsteel and two at Camp Montieth). There were three team rotations per year. The Camp Bondsteel canteen was always open. They provided emergency communications services for the military and civilians. CAS was supported out of Bondsteel and visits were also made to the sectors where troops were deployed. Communications only handled emergency messages for immediate family members. The messages usually came from one of the Red Cross chapters in the U.S. or Europe. If an immediate family member was ill or had a critical emergency they would contact the nearest Red Cross Chapter to send a message to the soldier or civilian in the field. The Red Cross used e-mail for sending

such messages. There were toll-free numbers for family members in the U.S. to call for assistance. The military sponsored billeting and other support services for the Red Cross workers on Camp Bondsteel and Brown and Root provided other support services such as bottled water and coffee. The military also gave the Red Cross access to the non-classified Internet protocol router network (NIPRNET), DSN and long distance commercial service for use under special circumstances.

Red Cross workers delivered emergency messages to soldiers from their families, as well as providing them with books and magazines. They were proactive in their attempts to support the soldiers, and provided movies, newspapers, and food in addition to other services. They even held monthly parties for everyone who had had a birthday.

CHAPTER XVIII

Coalition Command Arrangements

Larry Wentz

The Threat

Keeping the peace in Multinational Brigade East was a complex endeavor that encompassed a diverse variety of missions. The brigade's soldiers patrolled through cities and villages across 2,300 square kilometers of mountains and plains. The variations in ethnicity were equally dramatic. Ninety-one percent of the population of Kosovo (1.8 million) was Albanian. Seven percent were Serbian, and about half of them lived in the MNB(E) region. While few towns were comprised exclusively of one ethnic group, some communities could include several different groups. One of the best examples was Gnjilane, a town of nearly 70,000 people representing a mixture of Albanians, Serbs, Romas, and Turks.

As the summer of 2000 approached, crime and ethnic violence were on the rise and unexploded ordnance, such as mines and cluster bombs, posed serious concerns for the farmers working in the fields and children playing outside. Additionally, MNB(E)'s area of responsibility included borders with Serbia and the Former Republic of Macedonia, and these borders presented smuggling and counterinsurgency challenges. There were also asymmetric threats such as organized crime that needed to be dealt with.

A Complex Mission

Some units, such as civil affairs, had a substantially expanded mission in support of peace operations. The commander of TFF viewed civil affairs, PSYOP, and the communicators as combat multipliers in peace support operations. Civil affairs soldiers were out every day working

with UNMIK to help set up local governments and restore electricity, water and telephone service. They also worked with other international organizations and non-governmental organizations (NGOs) to provide humanitarian assistance and rebuild the civil infrastructure to improve the local quality of life. Soldiers were seen escorting Serbian children to and from school, delivering food, or checking on the welfare of the Serbs. In the U.S. sector, there were more than 30 churches and 25 schools under the watchful eye of the soldiers of MNB(E).

Many saw UNMIK as only capable of doing one thing at a time. When the international community and UNMIK were unable to provide services, KFOR soldiers were needed to fill gaps, requiring them to carry out duties that were beyond the scope of their mission and for which the soldiers were not necessarily trained to do. MNB(E) conducted civil military operations consistent with its mission and provided assistance to UNMIK. UNMIK established regional and municipal administrators, and although this gave them a significant presence at the provincial level, by June 2000 only 40 percent of the UNMIK regional and municipal positions were filled within the MNB(E) sector. MNB(E) only had three of the seven municipal boards functioning within its sector.

In the spring of 2000, the UNHCR was in the process of closing down its operation, having successfully housed and provided support for Kosovars during the winter months. UNMIK civil administration was in the process of picking up most of the United Nations High Commissioner for Refugees (UNHCR) responsibilities. UNMIK efforts to establish a functioning civil administration were being met with considerable resistance due to the ethnic conflicts between Albanians and Serbs, as well as the infighting between Albanian political parties. Furthermore, although many of the local leaders had positions on issues, they lacked a plan for implementing their ideas. MNB(E) served as the test location for civil registration and almost 50 percent of the eligible population was registered a month before the end of the registration period. Unfortunately, the Serbs continued to boycott the process and there was concern about the success of the October municipal elections. There was also some concern about OSCE's ability to provide resources for the voting process.

The European Union (EU) economic reconstruction efforts were almost non-existent in MNB(E) sector. Most of the previous reconstruction

had been privately funded by families living in Europe and the U.S. and through some U.S. DoD humanitarian assistance funds. MNB(E) was able to get about \$50K of EU money for two Village Employment and Rehabilitation Program (VERP) projects that targeted both Albanians and Serbs, and thirty-five additional VERP project requests were submitted to the EU for funding consideration. Funding was also being pursued through the U.S. Department of State (DoS) refugee coordination office in Pristina to support economic revitalization initiatives and MNB(E) continued to seek partnerships with other international and non-governmental organizations in support of its civil military operations.

The lack of a civil-military operations plan to coordinate, prioritize and synchronize activities between UNMIK, KFOR and the MNBs hampered CMO activities in the MNB(E) sector in particular. There were no agreed measures of effectiveness to help prioritize resource allocation or to measure progress and success of missions.

The mission of MNB(E) was four-fold:

1. To monitor, verify, and enforce as necessary the provisions of the Military Technical Agreement in order to create a safe and secure environment;
2. To provide humanitarian assistance in support of the UNHCR efforts;
3. To enforce basic law and order until this function is fully transferred to the appropriate, designated agency; and
4. To establish and support resumption of core civil functions. This included the establishment of information operations centers (to facilitate the flow of information to the populace), rebuilding schools and providing assistance to numerous humanitarian aid projects.

In June 2000, there were concerns about the future of UNMIK. The U.N. employee and UNMIK police contracts were about to expire. The lack of a legitimate civil infrastructure had created opportunities for “shadow organizations” to fill local power vacuums. Kosovo’s transition from a socialist to a market-based economic system was incomplete. UNMIK, KFOR and NGOs were employing locals as well as distributing

assistance to communities, and although this was a source of money, it also had the unintended consequence of supporting local power bases. These power bases and shadow organizations, coupled with a network of former-UCK, were controlling municipalities and villages.

The EU reconstruction programs scheduled to begin in July would be a major focus of UNMIK's future activities, but there was concern about whether these programs would get off the ground because the EU had suffered chronic shortfalls in money and staff in Kosovo. International financial support for Kosovo had not been very forthcoming due to the lack of clarity of the final sovereignty status of Kosovo. Neither the International Monetary Fund (IMF) nor the World Bank could carry out their traditional functions in Kosovo because they could not obtain the necessary "sovereign loan agreements." The return of Serbian IDPs (internally displaced persons) and Albanian refugees as well as the municipal elections were concerns in terms of the potential for renewed ethnic violence.

Challenging Command Arrangements

NATO Article V provides the NATO commander the military imperative and political importance necessary to accomplish the mission. Under non-Article V operations, such as the peace support operation in the Kosovo, this was not necessarily the case. Inadequate consideration was given to the likely operational impact of the inevitable national constraints and influences. The KFOR C2 relationships lacked specificity and were complex. Contributing to the confusion were the inadequate definitions of the Cold War derived NATO C2 states of command—operations command (OPCOM), operations control (OPCON), tactical command (TACOM), and tactical control (TACON). They were vague, leaving the nations to interpret them as they wished. This perhaps is one of the most important areas to be addressed before NATO conducts another peace support operation.

Unity of command was not achieved in the multinational KFOR operation—the NATO commander lacked the necessary leverage and control, and nations reserved the right to dictate how, where, and when their contributing forces would be employed and deployed. An attempt was made to at least achieve unity of effort—agreement and common understanding of the objectives and the desired end-state of the operation.

Even here there were significant challenges to overcome. Although KFOR established some broad objectives, the desired end-state was not politically defined. There was no UNMIK strategic plan and supporting KFOR campaign plan at the outset. The NATO military planning process was cumbersome and oriented towards Cold War defensive operations and not well suited for providing the strategic guidance needed for dynamic peace support operations. The North Atlantic Council approved operations plan for KFOR did not arrive until some forty days after KFOR arrived in Kosovo. Since there was little effective NATO and U.N. collaborative planning before entering Kosovo, UNMIK and KFOR did not have a clear understanding of the responsibilities, needs, and the projected duration of the operation. Communications interfaces to facilitate information sharing between the deployed NATO and national military networks and the in country networks used by UNMIK and the NGOs were also lacking. There was also an inadequate integration of the KFOR and MNB communications and intelligence capabilities to facilitate collaboration, coordination and situation awareness information sharing. This caused frustrations, disconnects and misunderstandings that led to the ad hoc establishment of a cottage industry of liaison officers and KFOR-sponsored working groups to help bridge the communications and information sharing gap.

The KFOR operation presented the U.S. forces (particularly the U.S. Army) with some interesting command arrangement challenges. They found themselves in both a support and lead role. As the lead nation for MNB(E), the U.S. commander reported to commander KFOR, a non-U.S. military officer with a multinational command staff. As commander MNB(E), he found itself in both a joint and combined operations situation. The U.S. Army was the lead service element, but there were members of the other U.S. service elements. For example, at the outset there were U.S. Navy Seabees and the 26th Marine Expeditionary Unit. The Air Force provided an Air Liaison staff and ran the weather forecasting operation. The U.S. element of MNB(E), referred to as Task Force Falcon, was built around a U.S. Army brigade with U.S. augmentations from the First Infantry Division, National and European theatre level intelligence organizations, and supporting military organizations such as aviation, engineers, signal, MPs, medical, Special Operations Forces, civil affairs, and PSYOP.

The commander of the intermediate staging base at Camp Able Sentry, Macedonia reported to the TFF commander. There were three non-U.S.

battalions (Russian, Polish and Greek) and several other non-U.S. troop committing nations military personnel assigned to MNB(E). The non-U.S. battalions were responsible for their own MNB(E) sectors and the commanders reported to the MNB(E) commander. This meant there would be situations where non-U.S. elements would be reporting to U.S. commanders and there would also be situations where U.S. units would be reporting to non-U.S. commanders. For example, U.S. units sent to support a riot in Strpce came under control of the Polish battalion commander.

As a complex multinational brigade, there were doctrinal, procedural, and linguistic challenges introduced that required time for the U.S. brigade elements to adjust to operationally. Language alone was a major challenge. Although English was the language of KFOR operations, English was not spoken by all multinational troops participating. Few Russians troops supporting MNB(E) spoke English. EUROCORPS provided the commander of KFOR and a number of staff officers that filled key KFOR headquarters positions. The language of operations for EUROCORPS was French. Although pre-deployment training included use of English, some EUROCORPS officers were not fluent in English and there were occasional miscommunications. In spite of these challenges, the KFOR and MNB(E) command and control processes worked.

Although MNB(E) was a combined operation, the headquarters was staffed solely with U.S. soldiers. The non-U.S. forces assigned to MNB(E) provided liaisons to the tactical operations center and the commanders of the non-U.S. units attended the Battle Update Briefings (BUB). They could not, however, attend the commander's morning intelligence briefing since it was a special access U.S.-only briefing. However, the evening BUB provided a KFOR-releasable Secret level intelligence briefing that they attended. In addition to the non-U.S. force liaisons at the TOC, U.S. liaisons (mainly Intelligence and Special Forces) were used to provide the linkage between the U.S. elements and the non-U.S. troop contributing nations of MNB(E):

- The 13th Tactical Group (Russian);
- 501st Mechanized Infantry Battalion (Greek);
- 18th Air Assault Battalion (Polish) supported by a composite platoon from Lithuania;

- The 37th Support Company (Ukrainian); and
- A composite battalion from the United Arab Emirates (including UAE ground and Apache aviation units and two Jordanian Army platoons).

U.S. liaisons were provided to KFOR, UNMIK and the OSCE as well. There was also a small Italian Carabinieri contingent of the Multinational Specialized Unit (MSU) assigned to MNB(E). Joint patrols and exchange and coordination meetings were held with non-U.S. units assigned to MNB(E) and with regional boundary units such as the Finish, Swedish, and British units of MNB(C). German, Austrian and Dutch units were OPCONed to TFF for a short period of time and U.S. units were temporarily deployed out of sector to Mitrovica to help the French with riot control.

The NATO coalition command arrangements were extremely confusing. There was no diagram that detailed the multinational command arrangements and tied the KFOR, MNB and non-NATO troop committing nations together. The five multinational brigade commanders reported to COMKFOR, who reported through the NATO chain of command to the North Atlantic Council. However, the brigade commanders and COMKFOR also had their own national chains of command. There were multiple NATO military headquarters involved in the KFOR reporting structure including SHAPE, LANDCENT, EUROCORPS, and AFSOUTH.

The Chain of Command

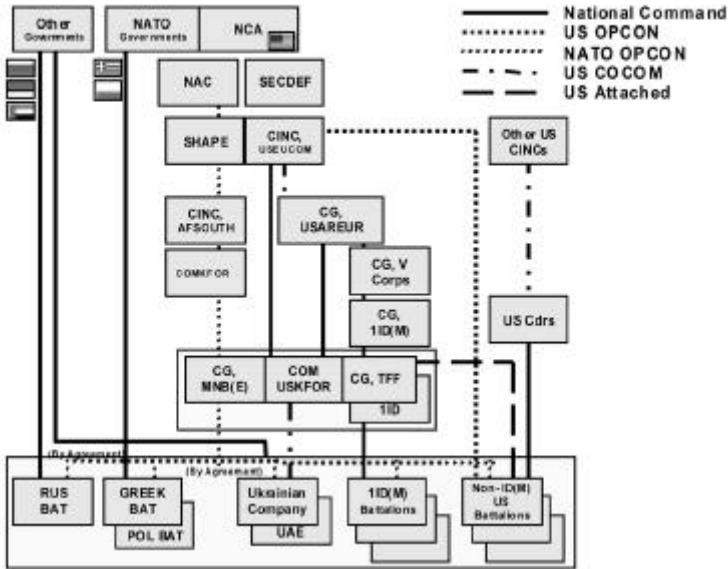

Figure 1. MNB(E) Chain of Command

The confusion was not limited to the NATO chain of command. The chains of command for the U.S. and other national forces were complex as well (Figure 1). As commander MBN(E), General Sanchez was one of five regional commanders subordinate to COMKFOR, a NATO commander. He exercised NATO OPCON over all assigned NATO forces. Non-NATO nations forces assigned to MNB(E) agreed to control similar to NATO OPCON with some reservations. For example, tasking to the 13th Tactical Group had to go through the Russian LNO and required approval of the Russian Minister of Defense.

As commander USKFOR, General Sanchez was the senior U.S. commander in Kosovo and responsible to the Commander in Chief, United States European Command (CINCEUCOM) for all assigned U.S. units and for the execution of U.S.-other nation bilateral agreements. He also reported to USAREUR for Title X responsibilities for all U.S. personnel, including non-U.S. forces by agreement. As the commander of Task Force Falcon, he was commander of all U.S. units assigned to TFF. In his role of ADC(S), 1 ID(M) he was responsible to commander 1 ID(M) for supervision of all deployed 1 ID units. He was also

sometimes responsible to V Corps for other basic U.S. Army chain of command reporting. U.S. National Command Authority approval was required for the use of U.S. forces out side of the MNB(E) area of responsibility or for special missions.

Sometimes guidance would come directly from EUCOM, or the Joint Staff, or even higher levels. It was necessary to monitor TFF tasking from U.S. superiors as well as demands for lower-level support in order to maintain balance and control. Officers needed not only to understand their superior's intent, but also to be able to trust their subordinates to execute that intent. U.S. elements were attached to the task force in different ways. Some units reported to multiple commanders. U.S. elements remained attached to their parent organizations, which retained some authority over them (CA and PSYOP were OPCON to Special Operations Command Europe [SOCEUR]).

The international presence in Kosovo combined the activities of a number of U.N. and non-governmental organizations (NGOs) in complex arrangements. The civil arrangements, while more complicated in structure, lacked the discipline of their military counterparts. As LTC Holshek, U.S. Army Reserve, points out in his writings on the operational art of civil-military operations, military operations focus on the use of linear structures to accomplish set objectives, whereas civilian organizations use organic, evolving structures to address ever-changing needs and goals. There were also the NGOs, who were even less structured, operated autonomously, and were unlikely to be held accountable to anyone other than their supporters for their actions.

Leaders who promoted trust and confidence and demonstrated open collaboration, cooperation, and sharing had an overwhelmingly positive impact on how well the rest of the civil-military organizations functioned together. The ability to share and cooperate was an integral part of the education and training of the participants. The civilian and military actors on the ground, including the NGOs, needed to develop a shared understanding of the political aspects and ramifications of the peace operation and the relative impacts of the actions of those who participated.

In the first-ever U.N. operation of its kind, the head of UNMIK was the Senior Representative of the Secretary General (SRSG) and was, therefore, the senior international civilian official in Kosovo. As such, he presided over the work of the organization. The SRSG and COMKFOR met every day, and their staffs supplied liaisons to each other. UNMIK

and KFOR established information centers throughout Kosovo as a means to facilitate collaboration, coordination and exchange of information. In spite of these measures, achieving unity of effort proved to be problematic, especially since there continued to be an absence of clarity about Kosovo's future in the international community and there was no political-military strategic plan for the operation. Further complicating the situation was the fact that there had been a chronic shortfall in money and staff to support the international civil effort.

After a year, UNMIK, in spite of its shortfalls, actually performed better than anticipated. By contrast, KFOR was struggling to avoid creating a culture of dependency, as experienced in Bosnia. To a large extent, the military was disappointed and frustrated with UNMIK, OSCE and EU performance in the areas of civil administration, institution building and economic reconstruction. After all, UNMIK success was viewed as the key to the military exit strategy and in their view, limited progress had been made in these areas over the previous year. International community shortfalls also required KFOR to shoulder more and more burdens and this served to further frustrate civil-military relationships. Sharing information with UNMIK proved to be a challenge as well; MNB(E) information was provided to UNMIK, but it was difficult to receive information in return. The UNMIK LNO provided TFF daily UNMIK reports and other UNMIK related information. He also provided daily TFF situation reports (SITREPs) to UNMIK.

The Multinational Specialized Unit

The Multinational Specialized Unit was a military police force first employed with high success in Bosnia. They were used in KFOR to combat crime and terrorism, to support KFOR civil disturbance operations, and to gather intelligence on organized crime. The MSU consisted of the Italian Carabinieri and Estonian forces. In MNB(E), the MSU team consisted of fifteen to twenty personnel with two English speakers. Warrant Officer Franco Battagua commanded the team. They were well armed with Uzis, pistols, and other weapons. They had both secure and non-secure means of communicating; however, the systems they used did not interoperate with U.S. forces communication systems. Both Serbian and Albanian interpreters were employed. Before deploying into sector, they would check in with the MNB(E) TOC to get a situation update and to let the battle captain and sector commander

know they would be in the area. On the morning I went out with them, we first visited the TOC to talk to the battle captain and multinational LNOs, and then scanned the butcher paper that was used to record daily events before departing on mission.

I was fortunate to have been invited by the commander to go on patrol with them. The purpose of the mission was to conduct an initial reconnaissance of possible drug and weapons smuggling routes and weapon storage areas. One team went to Strpce to speak with a UNMIK administrator who had asked for protection. The other team (which I accompanied) proceeded to Basici and Vrnez, which were abandoned Croatian villages. Then we headed to Letnica. These villages were very near the FYROM border, which was heavily mined.

During discussions on the way to Basici and Vrnez, the commander explained that their primary mission in Kosovo was riot control, investigations into organized crime (drugs, smuggling, enslavement and prostitution) and terrorism. The commander said they were prepared to help the task force if asked. The Carabinieri provided situation reports to the TFF G2 and G3 and worked with the battalions, but it was not always as a full task force team member. Part of the problem was that the U.S. elements had broader expectations of skills than the MSU could contribute. Therefore, there was a lack of adequate understanding on the part of U.S. elements of their true strengths and how they could be employed.

It was noted that investigative work was difficult in Kosovo since standard techniques of wiretapping, bugging rooms, infiltration of organizations, and wearing civilian clothes could not be used. They needed to rely on surveillance and informants, but it was difficult to work with informants. People of interest were under pressure not to speak to KFOR. Also, it took time to check out an informant before they could be trusted and used. Frequently, KFOR soldiers asked Carabinieri informants for information or tried to use these contacts without coordinating with the Carabinieri. De-conflicting human intelligence (HUMINT) activities in sector was difficult because nearly everyone was collecting intelligence.

As we approached the town of Basici, we stopped to talk to a shepherd. The shepherd told us while there were no mines along the road, the mountains were more dangerous. We later met up with some workers who had just returned from Italy over the mountains and they reported

that there were many mines. While driving up the hill towards Vrnez, we stopped several times so the commander could survey the area for activity. The Carabinieri were much more cautious moving into this area than the tactical PSYOP team that I had accompanied a few days earlier.

The town of Vrnez had a large church and a schoolhouse, both of which were abandoned. There was a high probability of drugs and weapons smuggling in the area. There were a number of people working in the fields, but the town was essentially empty. Since the town was abandoned, people from other areas came up to harvest the hay fields. Most of the homes had been ransacked, and doors, windows and electrical parts had been removed. The Carabinieri spoke to people who indicated some activities in the mountains near the FYROM border. The commander decided to drive to this area to see if we could find any possible evidence of smuggling activities. The remaining team members stayed behind in Vrnez.

We drove out on a road that was nearly impassable. It was steep, narrow, rocky, and muddy at points. We followed the road until we came to a point where it was too narrow, rough, and steep for the Range Rover. We stopped and the commander and I proceeded to walk up one of the trails in search of any evidence of use (Figure 2). The driver remained in the vehicle. There were track marks that looked like a small tractor, hoof marks that could have been a horse or donkey, and footprints. There was other evidence of activities such as scraped rocks, bottles, seeds, and beer cans. With the overgrowth on the narrow trails, it would be easy to conceal oneself from helicopters. We walked back to the Rover and then up another trail that was far steeper than the first and had multiple branches. Again there was evidence that someone had come along these routes. We found some trees that had been chopped down and there were trail markers painted on rocks.



Figure 2. Carabinieri Commander Looking for Evidence

We returned to the other team members in the town of Vrnez and proceeded to Letnica. When we arrived in the village square, there was already an UNMIK police car, two MP Humvees, and a few KPS personnel walking around. We decided that there were too many people to do anything useful so we returned to Camp Bondsteel. I asked the commander what he thought about Kosovo and he said he felt it was a mistake to have gotten involved. In his view, there was not any real hope for the near future.

UNMIK Police

The UNMIK police operation was significantly different from previous U.N. civilian police missions. The UNMIK police were the only law enforcement unit in Kosovo. The Security Council Resolution 1244 tasked UNMIK with two strategic goals: (1) to provide temporary law enforcement, and (2) to establish a professional, impartial and independent local police, called Kosovo Police Service. The mission of

the international police force would be completed when the local police were able to enforce law and order according to international standards.

To achieve the goals imposed by the Security Council, UNMIK police had to adjust their functions over three distinct phases of operation:

- In the first phase, KFOR would be responsible for ensuring public safety and order until UNMIK could assume that function. Until the transfer, UNMIK's civilian police would advise KFOR on policing matters and establish liaisons with local and international counterparts. UNMIK border police would advise KFOR units stationed at the border.
- In the second phase, UNMIK would take over responsibility for law and order from KFOR. The UNMIK civilian police would carry out normal police duties and would have executive law enforcement authority. UNMIK civilian police would initiate on-the-job training, advising and monitoring for local recruits. UNMIK special police units would carry out public order functions, such as crowd control and area security. The special police units would also provide support for UNMIK civilian police and protect UNMIK installations. At that time, any special police unit previously under KFOR command would be transferred to UNMIK to achieve unity of police command. The United Nations border police would ensure compliance with immigration laws and other border regulations. KFOR would continue to support UNMIK in these efforts as required.
- In the third phase, when enough properly trained local police became available, UNMIK would transfer responsibilities for law and order and border policing functions to the Kosovo Police Service. At this time, UNMIK civilian and border police would revert to training, advising and monitoring functions. UNMIK special police units might still be needed as a backup.

As of April 2000, UNMIK Police had complied with the second phase tasks and their main activities included:

- Patrolling and maintaining public order;
- Investigation of crimes;
- Preventive measures;

- Field training for the KPS;
- Collection of criminal intelligence;
- Border and immigration control; and
- Traffic control.

The international police force was under the UNMIK civil administration and was commanded by a police commissioner. He exercised operational, technical and disciplinary authority over all police personnel. The commissioner reported to the SRSG from the UNMIK police headquarters in Pristina. CIVPOL had five regional headquarters located in Pristina, Pec, Gnjilane, Prizren and Mitrovica. The Organization for Security and Cooperation in Europe and the United Nations civil administration were responsible for recruiting and training police officers for the new Kosovo Police Service. UNMIK police worked very closely with the OSCE to establish a new police force in Kosovo that was organized and functioned according to internationally recognized standards of democratic policing. The police academy, called Kosovo Police Service School, was established by OSCE in order to provide initial training for the police applicants. The UNMIK police and OSCE Department of Police Education and Development cooperated in processing applicants. Upon successful completion of the KPS School, each candidate was assigned to an UNMIK police station to begin seventeen weeks of field training and an additional 80 hours of classroom work provided by OSCE police instructors.

The UNMIK police was prepared to absorb KPS into its field training. Since the initial training course was short, the field-training component was vital to achieving the goal of a viable, professional and politically independent KPS. The KPS trainees and provisional officers served as an integral part of UNMIK police until they were assessed to be sufficiently trained and capable to conduct their police duties independently. Promising trainees in the program were identified for specialized or management training. The KPS was the only functioning multi-ethnic public service institution in Kosovo. Tremendous efforts were made to ensure fair representation of all minority groups in Kosovo, including Serbs. As of July 30, 2000, over 1300 local police officers representing all of Kosovo's communities had graduated from the police school.



Figure 3. Vitina UNMIK Police Chief

While visiting the Vitina civil affairs tactical support team (TST), I had the opportunity to visit with the Vitina UNMIK police chief, Mr. Kraus, (Figure 3) a German national. I also talked with one of the U.S. Army MPs, Lt Jackson, who had worked on organized crime activities while stationed in Vitina. UNMIK police and KFOR/MNB(E) had a very good working relationship, having been collocated at the Vitina Police Station. Local residents were generally co-operative with KFOR, even though KFOR imposed a curfew due to interethnic strife and criminal acts. Although both had very good working relations with the local community, the UNMIK police felt they could have had more of a positive impact if they had been provided with more police officers and additional organization support.

Insufficient resources affected every aspect of the police. Not everyone had weapons and many that did brought their own weapons from home, including the UNMIK police chief. There were 54 officers, but only 25 handset radios. The police station had five Posts and Telecommunication Kosovo (PTK) local subscriber lines, but only one telephone. Although there was limited telephone connectivity between the offices in Vitina and Pristina, the quality was so poor that the UNMIK police office had to call a Gnjilane switchboard to call Pristina. The international maritime satellite (INMARSAT) was used for voice and fax, but it did not work well on the first floor of the station where the

duty office was located. U.N. VSAT access was being installed to give the station enhanced voice and data service including connectivity to other UNMIK police facilities in Kosovo.

The UNMIK police were confronted with several issues related to the nationalities of the officers. UNMIK did not have standard uniforms. Instead they were provided by the sponsoring nation. For example, the German police wore black and the U.S. wore blue. The only UNMIK police that the locals really want to deal with were those from the U.S. and western European countries. There was an impression that officers from Asian and African countries were more interested in being paid than in serving the community. These police officers spent a lot of time in cafés, so local Serbs didn't believe they would be an effective force to ensure their protection.

Information system support for UNMIK police was pretty basic. The Vitina police station had computers, but they were not yet linked together. The police chief brought a hub router with him to link the station computers and printers together. There was a Kosovo-wide police information database on criminals, which was kept on the UNMIK police headquarters computer in Pristina. The database was not automatically fed from the UNMIK police stations throughout Kosovo and it was not accessible electronically from remote locations. Maintaining the databases was a time consuming and error prone manual process. Municipal police station updates such as those at Vitina were put on a disk once a week and then hand carried to the Opstina level UNMIK police station (for Vitina this was Gnjilane). At the Opstina level station, the municipal inputs were integrated with other inputs from the Opstina and then hand carried to Pristina to manually update the Kosovo-wide database. The previous week's database was picked up and brought back to the Opstina level police station and then passed on to the municipal level police stations to update their databases. This meant the Vitina version of the Kosovo-wide database ran about a week behind. Once the U.N. Very Small Aperture Terminal (VSAT) network was fully operational there were plans to link police stations and provide means for automated database updates and remote access of the database in Pristina.

Police candidates had varying skills related to policing and attitudes about what to do. For example, the Vitina chief cited incidents where Asian and Indian police refused to arrest people because they didn't want to create a disturbance. Requisite skills included the ability to

speak English, a driver's license, and shooting skills. Nations providing candidates conducted the qualification screening, but not all candidates met these qualifications. Some could not speak English, could not drive, and there were cases where some were not even police officers.

UNMIK police provided 1 week of orientation at the Pristina indoctrination center. Many nations were sending older officers rather than younger ones. UNMIK needed experienced officers to educate the KPS and train them to be good policemen, but they also needed some younger officers to meet the policing demands on the streets. The new KPS recruits did not want to be assigned to non-European and non-U.S. UNMIK police officers. They felt they would not learn anything. The duration of national assignments varied. For Germany it was 9 months, France 6 months, and for the U.S. and the rest it was generally a year assignment.

Basic policing tools such as handcuffs, vests, and pistols were provided by most nations sending officers. There were no standard weapons and they did not have any high-powered weapons. The UNMIK police officers were out-gunned when they encountered gangs.

Vitina station had twelve police vehicles. One was the "paddy wagon" for transporting criminals and one was a "white car" so it could be used to cross the border. White U.N. vehicles facilitated border crossings. UNMIK had two specialized units for riot control—a Jordanian and Indian unit. Locals were very friendly. The Kosovars, both Serbs and Albanians, were starving for law and order.

Shadow governments under control of Serbia still existed and taxed local businesses. Although it was suspected, shop owners would not admit it for fear of having their businesses destroyed. Organized crime involved both UCK and non-UCK. Xhavit

Hassani was the most respected and feared member of the organized crime community. When he was arrested, 600 protesters showed up in the streets. Hassani had an office in a building near the UNMIK civil administration building in Vitina and he had ties to illegal taxation, drugs, arms smuggling and prostitution. It was also believed that he was sending money to the UCPMB.

While in Pristina visiting Col Mike Dziedzic, U.S. Air Force and UNMIK strategic planner, I had the opportunity to visit the UNMIK police criminal analysis team. They were building a crime database and

conducting rudimentary assessments. Col Dziedzic was trying to get NIMA to release maps to them so they could do more detailed profiling of where crimes were being committed. They were planning to do trend and link analysis as well. The analyst team was trying to convince senior UNMIK police leadership of the value of their work and gain their support for acquiring improved tools and information systems to do their job. Data reporting was primitive and prone to errors, from filling out the initial reports to the station commanders who did not necessarily review them before sending them forward to higher headquarters. Without structure, process and discipline they were suffering the GIEGO effect—garbage in equals garbage out.

The UNMIK police statistics were available on an Internet Web site at <http://www.civpol.org/unmik/>. Crimes were being reported more often. A likely reason for this increase in reports was the growing trust between the locals and the police force. The increased reporting was a very good indication of the development and improved abilities of the police force.

MED Falcon and MEDCAP/DENCAP

A combat support tent hospital, Medical Falcon, was set up on Camp Bondsteel and included a full emergency medical treatment section equivalent to any urban emergency room. In some cases it may have treated as many weapons related wounds and injuries from car accidents per week as an ER in the states. There were two modern, fully equipped sterile operating rooms and their surgeons were capable of performing almost any life-saving surgery. While I was there an 8-year-old girl was shot and brought to Bondsteel. Thanks to the prompt action of the U.S. Army medical team and post-operative care she survived. The intensive care unit held up to eight critical patients. The intermediate care ward held up to 20 patients. In addition to state of the art medical care, the hospital also provided veterinary, preventive medicine, optometry, dentistry, and psychiatric support.



Figure 4. Hospital in Action

Emergency medical care was provided by the Camp Bondsteel medical treatment facility to any person with the threat of loss of life, limb, or eyesight. Numerous Kosovar Serbs from even the most uncooperative, hard-line communities willingly received emergency medical treatment at Camp Bondsteel. A leading Serbian Orthodox cleric, Popa Dragan, was seriously injured in a drive-by shooting and required a series of medical treatments at Camp Bondsteel. He reported that wealthy relatives offered him the opportunity to receive medical treatment elsewhere, but he declined, as he trusted the care he was receiving at Camp Bondsteel. The former KLA leader and resurgent political celebrity Ramush Haradinaj was transported to Camp Bondsteel for medical treatment after being injured in a confrontation in MNB(W).

The MNB(E)/TFF medical personnel made house calls. This was done through routine MEDCAPs and DENCAPs that were conducted several times a week by military medics and doctors who traveled to remote areas that didn't have a medical facility. The commander responsible for the sector and towns frequently requested and scheduled medical team visits, sometimes referred to as "tailgate medicine." The sector commander and supporting civil affairs team worked with the town mayors to select sites to be visited. Visits were conducted three times

per week per sector on the average. For major medical concerns, individuals were referred to the nearest hospital. Most problems tended to be muscular-skeletal problems and skin problems, commonly rashes. Typical treatment was dispensing pain relievers. Dental personnel provided similar services and also spent time visiting schools to talk to the kids about oral hygiene and foods good for their teeth. They passed out toothbrushes, donated by companies in the states, and instructed the kids how to use them. Most young children's teeth were in extremely poor condition.

Some field commanders felt the MEDCAP program needed some fine-tuning, especially where visits were made to the same sites too often and remained there too long. In some communities, MEDCAPs were being made to communities that were already covered by U.N. funded, Serbian run clinics and by NGOs such as Medicine Sans Frontiers. There was a need for the MEDCAP leadership to conduct community assessments to determine where needs existed and then work with civil affairs to try to get NGOs to provide medical care so the KFOR resources could be used on communities still untouched by MEDCAPs. The TFF Surgeon maintained historical information on MEDCAP and DENCAP visits to support assessments and for use in future planning and targeting efforts. Sustained medical care was not a KFOR responsibility.

I was fortunate to be able to ride along with a MEDCAP team out of Camp Montieth to the Serbian side of the village Kmetovce. This particular village was visited about every other week. The clinic was set up in a small schoolhouse. One schoolroom was used as the initial screening area. People arriving to seek treatment had their vital signs and medical information taken before the patient saw a doctor. The medics, who had interpreters working with them, checked blood pressure, took temperature measurements, pulse rates, and patient information was recorded. Those who needed to see a doctor were sent to another room for examination and medication.

When the team first showed up at the schoolhouse, a few children came around the vehicles. Soon it seemed like every child in town showed up out of nowhere. Gradually the adults, mostly the elderly, began to show up. (Figure 5). The medics worked well with both the young and old. They were friendly, kind, and even though they didn't speak the language, they joked with the patients.



Figure 5. Medic Taking Temperature

The children constantly pestered us for candy, drinks, U.S. flag patches, and money. They were watching the medics and trying to peek in the rooms where the medical exams were being conducted. When we arrived, there was an old lady herding her goats in the road next to the school. Later another goat herder came by and shook my hand. There were pigs and chickens running around. Even the adults get pushy for things and are a constant challenge to deal with. Some of the young men said they had been promised fuel from an earlier visit. They asked a couple of soldiers if they could have some fuel from the cans on the back of the military vehicles and were told they could. In the meantime, the Sergeant in charge came by and stopped the action. The Serbian men were quite angry and argumentative. Some of the soldiers passed out candy and U.S. flag patches to the children, who later tried to get some soft drinks which were not given to them. As the vehicles depart, the children started spitting on them and flashing the three-finger VJ victory sign. The situation in Kosovo was volatile and could change at a moment's notice, even for humanitarian efforts such as MEDCAPs.

Camp Bondsteel Detention Facility

Because there was no functioning Kosovo civil prison system in place when KFOR and UNMIK arrived, it was necessary for KFOR to set up detention facilities. MNB(E) established a detention facility on Camp

Bondsteel. The military stressed that this was a detention facility, not a prison or a POW facility. The detainees were civilian criminals awaiting trial and sentencing. Although in some ways similar, internment operations in Kosovo were quite difficult and different than POW operations for which the MPs were trained to conduct. Long-term detainees required different handling than POWs where prisoners moved in and out quite frequently. In addition to guard towers, living areas, portable showers and toilets, the detention facility had to provide for administrative processing, interrogation, visitors, lawyers, and judges and a courtroom. A visitation program similar to that of a civilian regional correction facility was set up. It was also necessary to set up procedures for medical care and dispensing medication.



Figure 6. Detainees

The detention facility began in June 1999 as several tents surrounded by triple-stranded concertina wire to hold about 48 detainees. A year later it was a much larger facility that could hold about 130 detainees and was growing. Detainees wore bright orange jump suits (Figure 6) and MP guards and K9 teams patrolled the detention facility. Soldiers rotated between guard towers, static guard duty, and roving patrols. Early in the operation, there was essentially no penalty for breaking the law, so the average detainee stay was 72 hours. However, this changed

when the judicial system started to function. In June 2000, the facility averaged 65 detainees inside the fence on any given day and the average stay was about 110 days.

Generally speaking, the Serbs were not the ones committing the violent crimes nor were they picked up on minor crimes. Albanians, on the other hand, had a reputation for making trouble. The Serbian community misinterpreted the situation and began to believe that if they were arrested by KFOR and sent to the Camp Bondsteel detention facility, then they would never return. There was a need for the information campaign to correct this misperception by making the actual situation more clear to the Serbian community in general.

More than 1,500 detainees had been processed since the start of the Kosovo mission. The detainees displayed a similar criminal mentality to prisoners in the United States. New detainees often asked where the prisoners were beaten or executed. Once detainees realized that they would receive humane treatment, the information flow, as little as it was, ceased. Overall, the facility did not have any major problems, except for one escape attempt and some minor disturbances. Detainee status and related activities were briefed to the MNB(E)/TFF commander each morning and then again at the evening BUB. The Kosovar judicial system was improving and courts were taking an active role in facilitating the future of the detainees. Kosovar prison facilities were starting to open up to accommodate convicted criminals.

Sergeant Kasun, U.S. Army, conducted a most informative and interesting tour of the Bondsteel detention facility for me. Upon arrival at the detention facility there was a canvas-covered perimeter wire fence and guard towers that surrounded the main compound. Access to the detention facility was through a locked double gate area that one had to enter before being allowed access to the main compound. Once inside the main compound there were several fenced-in areas within another controlled access area. The operations center was located in a tent inside the main gate. This was the command and control center for the facility and where detainee information was recorded and maintained. When a detainee arrived, he or she was photographed but not finger printed. They had a finger printing capability but were missing some pieces to be able to do it at the time of my visit. Handheld Motorola radios were used for communications within the compound. Sergeant Kasun felt they did not have enough radios and also noted they were

having problems with the rechargeable batteries, which contributed to the shortage.

Inside the controlled access area of the main compound there were six separately fenced areas. In the center of each fenced in area there was a tent on a wooden platform that housed detainees. It was necessary to separate Albanians and Serbs, men and women, and adults and juveniles, as well as to provide a separate facility for disturbed or dangerous detainees. Attempts were made to try to balance the number of detainees to a maximum of ten per tent. There were some new facilities being constructed out of plywood in another series of fenced in areas that would be used for juveniles and disturbed detainees. Due to a lack of funding, the MPs were building these facilities instead of the camp contractor, Brown and Root. The MPs also built the guard towers and platforms for the tents. There was a shower tent and port-a-johns located inside the main compound. The detainees were escorted to these facilities. For medical attention, detainees were taken to the MASH hospital down the hill from the detention compound.

The meals, a diet of MREs and bottled water, were served to the detainees. Although surprised at first that detainees were not eating the same meals as the soldiers, the International Committee of the Red Cross (ICRC) concurred that MREs, given the sanitary conditions and general poor health (active TB and heart problems) of some of the detainees, provided the safest food source. The ICRC visited the facility several times and provided some reading material and cigarettes for detainees. The MPs also provided sleeping bags, cots, personal hygiene items, shower shoes, personal items storage bins, pants, shirts, coats, boots, games, books, reading material and other items for long-term incarceration detainees.

A few hunger strikes occurred, usually during weekend visitation periods when their families brought them food. The detainees cut off this practice after the MPs told them they would start feeding them intravenously. Earlier in the year there was one escape attempt by three individuals. Two got away and one was captured.

There was a tent that served as a court, a meeting room for visitors, and other activities. Visitors were allowed to bring cigarettes and non-perishable foods for detainees. The MPs searched all items before they were given to them. The visitors were searched as well before entering

the visitation tent. Families and detainees met in the tent and sat on benches across from each other. There were a couple of MPs in the tent to monitor activities. There were also tents used for interrogations. The MPs and CIVPOL/UNMIK police interrogated the detainees. The resident UNMIK police officer Lt Paul Ories, a deputy sheriff for the county of Essex in Virginia, assisted with the processing and transport of detainees to their court hearings and did interrogations as well. The MPs and UNMIK used local and Computer Aided Translation (CAT) II translators. CAT II translators were used for sensitive counterintelligence and combat identification (CID) interrogations.

CHAPTER XIX

Operations

Larry Wentz

Setting the Stage

LT C Dave Hogg, U.S. Army, was the MNB(E)/Task Force Falcon G3. He came to Kosovo with extensive Balkans experience, but he still felt that this was probably one of his toughest operational assignments. He found that in addition to performing the traditional military support to peacekeeping operations, he had to worry about the possibility of fighting breaking out between the UCPMB and the VJ/MUP in the Presevo valley, weapons smuggling and counterinsurgency operations on the MNB(E) borders with Serbia and the Former Republic of Macedonia, and combating increasing ethnic violence and organized crime activities. There were also concerns related to refugee returns and registration and planning for the upcoming Kosovo elections, including the potential for violence due to political power struggles.

There were other considerations as well. Every Opstina in MNB(E) had different problems and there were different civil-military approaches to their solutions. There was no political-military or KFOR strategic plan. Additionally, there was no KFOR civil-military operations or information operations plan. As a result, integration and synchronization of UNMIK, KFOR, the MNBs, IOs, and NGOs efforts were problematic. There were also perceptions that MNB(E)/TFF was being too risk adverse and this needed to be dealt with as courses of action were developed and executed. MNB(E)/TFF headquarters was in reality a brigade-plus (division-like) operation, which presented command staffing challenges. This was because TFF was essentially staffed with brigade-level experienced officers instead of divisional-level officers. In general, the TFF staff lacked peace operations expertise and experience as well. As a result, both experience and expertise short falls had to be accommodated to meet the needs of a brigade-plus operation. In addition

to dealing with short falls, it also was necessary to continuously accommodate changes in leadership and staff. The frequent turnovers had to be carefully managed in order to minimize disruptions to the continuity of operation and stability of the organization.

Achieving unity of effort in the MNB(E)/TFF operation was difficult, but it was further complicated by having to accommodate KFOR C2 arrangements that favored consensus and leading by committee as the preferred way to conduct operations. There were other challenges related to command and control of non-U.S. forces under MNB(E)/TFF command. Most non-U.S. forces were under NATO OPCON but tasking the Russians required their Ministry of Defense approval. There were also concerns that high-level political decisions were being made without adequate consideration and appreciation of local impact.

Command and Control

A typical week in MNB(E) was quite active. The following snapshot illustrates many, but not all, of the operational activities soldiers were engaged in the MNB(E) area of responsibility over a 1-week period in June 2000:

- 1,470 Security patrols (day and night);
- 200 staging/infiltration zone operations patrols;
- 350 Hot Gun, force protection, and QRF missions;
- 112 Aviation missions;
- 49 Checkpoint operations;
- 81 Fixed-site security missions;
- 40 Satellite camps;
- 2,653 Squad-size missions;
- 7,500 to 9,000 PSYOP products distributed;
- 10 Combat Camera missions;
- 8 to 10 MEDCAPs/DENCAPs;

- 15 civil affairs projects;
- 5 to 9 live PSYOP radio and 1 television show;
- 4 to 5 press releases and media events;
- 7 types of bilateral meetings with local leaders, plus KFOR, UNMIK, OSCE, and NGO meetings; 50 to 60 contacts weekly; and
- 7 to 10 VIP visits to Task Force Falcon.

The Task Force Falcon battle rhythm (see Figure 1) was brutal. There were lots of meetings throughout the day and well into the evening, many occurring after 8 p.m. The commander’s intent and priority drove operational priorities, activities, and headquarters’ battle rhythm. Headquarters workdays of 15 to 18 hours were not unusual and it was quite easy to get caught up in the high op tempo routine since there was little else to do. Staff burnout was a serious concern and continuous efforts were made to encourage staff to get adequate sleep and take some time off to do physical training and general relaxation, read a

	Sunday	Monday	Tuesday	Wednesday	Thursday	Friday	Saturday	
0600 - 0715								0600 - 0715
0745 - 0845		CO Synchron Mtg	CO Synchron Mtg	CO Synchron Mtg	CO Synchron Mtg	CO Synchron Mtg	CO Synchron Mtg	0745 - 0845
0830 - 0930		BUS	BUS	BUS	BUS	BUS	BUS	0830 - 0930
0930 - 1000	DUD AGC	ACL	ACL	ACL	ACL	ACL	ACL	0930 - 1000
0930 - 1000	Combs							0930 - 1000
0930 - 1000		Lang Range Plans Mtg				Q2X Update	CoS-Primary Staff Call	0930 - 1000
1030 - 1100								1030 - 1100
1100 - 1130	Go/No Go Meeting			Info Ops Working Grp				1100 - 1130
1130 - 1200								1130 - 1200
1200 - 1230								1200 - 1230
1230 - 1300								1230 - 1300
1300 - 1330								1300 - 1330
1330 - 1400								1330 - 1400
1400 - 1430	Coord & Staff	Initial Tgting Meeting	CS Plans Meeting	Executive Targeting Mtg		CS Plans Mtg	Target Planning	1400 - 1430
1430 - 1500								1430 - 1500
1530 - 1600	CoS Conference							1530 - 1600
1630 - 1630								1630 - 1630
1630 - 1700	JVB	JVB	JVB	JVB	JVB	JVB	JVB	1630 - 1700
1730 - 1800								1730 - 1800
1830 - 1930		BUS	BUS	BUS	BUS	BUS	Big BUS	1830 - 1930
1930 - 1930								1930 - 1930
1930 - 2000	CoS-Plans Huddle	CoS-Plans Huddle	CoS-Plans Huddle	CoS-Plans Huddle	CoS-Plans Huddle	CoS-Plans Huddle	CoS-Plans Huddle	1930 - 2000
2000 - 2030								2000 - 2030
2030 - 2030								2030 - 2030

Figure 1. Task Force Battle Rhythm

Distinguished visitors were an integral part of the fabric of TFF life that was given priority consideration by the commander and required full-time attention. COL Landry, the Task Force Falcon Chief of Staff, spent a lot of his time helping work this activity until a senior military officer was brought in to fill the JVB OIC position. The commander’s daily to-

do list included the constant stream of VIPs, the list of which was briefed daily at the battle update briefings (BUB). The Chief of Staff tried to limit the number of high-level distinguished visitors to a maximum of two per day in order to make sure they got proper treatment. There were also a large number of other visitors, referred to by COL Landry as BRAs (Bubbas running around) in sector that required TFF caring, feeding, and other support as well.

The first main event of the day at Task Force Falcon headquarters was the 8 a.m. battle update briefing (BUB) in the main briefing theater in the TOC area followed by a U.S.-only intelligence briefing in the Analysis and Control Element (ACE), a U.S. special access secure facility. The morning BUB, which covered subjects such as weather, UAV status, current ops, aircraft utilization, and FRAGOs, normally ran a half-hour or less. The last regularly scheduled event of the day was a BUB at 6 p.m. that summarized the key events of the day and usually lasted less than an hour. On Saturday evenings the BUB would run at least an hour since an even broader set of organization elements briefed their week's activities. Sunday was a day off for BUBs but there was an ACE Ops-Intel briefing in the morning and in the afternoon, there was a 1-hour meeting between the TFF Commander and his staff followed by an hour meeting with his non-U.S. forces commanders.

Obviously a great deal of other activity was ongoing including preparations for the BUB and ACE briefings and other command level briefings and meetings held throughout the day and evenings. There were numerous weekly briefings and meetings scheduled in advance that related to operations, targeting, planning, information operations, civil affairs, PSYOP, public affairs, intelligence, Joint Visitor's Bureau, and other TFF Ops-Intel and command support activities. There were also unscheduled events such as the establishment of a Crisis Action Cell (CAC) in the TOC (used the BUB briefing theater) to monitor and manage unfolding critical events requiring the commander's involvement and use of force, including the QRF. A CAC could be set up in less than 30 minutes and was usually initiated in response to the spontaneous occurrence of a sector incident such as a roadblock of a major highway, a demonstration, or a riot, and these events could happen day or night.

There were also external meetings, such as the weekly meeting between the Commander of MNB(E)/TFF and COMKFOR, and the TFF Chief of Staff meeting with his KFOR counterpart. The MNB(E)/TFF Commander

met every Sunday with the UNMIK regional administrator and the UNMIK police and every other week he met with the KPC regional commander. There was an UNMIK four pillar (UNMIK Admin, UNHCR, OSCE, EU) meeting every Monday evening in Gnjilane which the Deputy Commander MNB(E)/TFF and the TFF G5/Civil Affairs Commander attended. A weekly Joint Security Committee (JSC) municipal meeting was held and included the UNMIK administrator, NGO representatives, the civil affairs team chief, and local ethnic group representatives. Although invited, the local Serbian representatives rarely attended. The meeting was chaired by the MNB(E)/TFF maneuver commander responsible for the area. There was also a weekly regional level JSC meeting chaired by the TFF commander. The civil affairs team chief assigned to the key municipalities met daily with UNMIK, OSCE, NGO, and others as necessary to work a variety of local issues such as distribution of supplies, restoration of phone service, and other things that needed to be fixed. There were weekly KFOR-sponsored information operations and PSYOP working groups with the MNBs and biweekly Joint Implementation Commission, civil affairs, and public affairs working groups and meetings. The KFOR-sponsored meetings alternated between Film City in Pristine and the MNB headquarters. TFF civil affairs team chiefs also held frequent meetings with the local Serbian clergy to keep them informed of KFOR efforts and to address issues of concern to them. There were numerous other KFOR, UNMIK, OSCE, and EU sponsored meetings and working groups that TFF commanders and staff attended. They also met with senior Albanian and Serbian religious and community leaders. There were also MNB(E) civil affairs, PSYOP, and intelligence related bilateral initiatives to strengthen collaborative arrangements with the lead nations of the MNBs on its border—the UK for MNB(C) and Germany for MNB(S).

The G3 plans shop was a constant center of attention and meetings. There was a continuous flow of U.S. and non-U.S. staff in and out of the planning area. Part of this activity was no doubt due to the fact that headquarters staff elements were physically spread around the TOC area, which did not serve to facilitate information sharing and collaboration. Furthermore, the information systems were not used effectively for collaboration (other than e-mail exchanges), so it was necessary for the staff to physically get together. For example, the collaborative planning tools available on SIPRNET were not used. The G3 and G2 planners (MAJ Jones and MAJ Latham) worked together daily in the G3 plans area as an Ops-Intel team even though the G3 and

G2 shops were in physically different locations within the TOC area. There were G2 and PSYOP liaisons collocated in the plans shop and the information operations cell that included the LIWA team was collocated with them as well.

There were no NATO or U.S. secure-phones in the G3 planning area. Unsecured DSN phones were on all desks and there was one KPN unsecured KFOR phone, which was hardly ever used. The unsecured phones in a classified planning area presented an OPSEC problem, especially when classified discussions were being held at the same time as unclassified conversations were being held on the unsecured phones. This happened often throughout the day and finally it was necessary to have someone monitor the situation and alert those having the classified discussion that an open line existed and to hold up on the classified discussions. Use of the unsecured phones during classified discussions was discouraged as well.

Access to the plans area was not tightly controlled, which meant there were staff entering and leaving during classified discussions and classified wall charts, displays, and other classified material were lying around as well. The U.S. secret-level SIPRNET workstations were on most desks and the screens were visible to those walking through the area. Additionally, care needed to be exercised since many of the discussions were U.S.-only, yet there were non-U.S. staff in the TOC area from time to time. Local hire cleaning crews also showed up at random times during the day and the area needed to be secured before allowing them in. Eventually *Do Not Enter* signs were posted on the doors to the planning areas and a person was placed near the doors to prevent entry of unauthorized personnel when classified planning and briefing activities were in progress.

The G3 planning was, by tactical operations necessity and time urgency, more focused on the short term, many times at the expense of long term planning, which was lacking. For example, there was no MNB(E) campaign plan. MNB(E)/TFF needed a future plans cell and they also needed an operations-independent lessons-learned cell. The Center for Army Lessons Learned (CALL) or the USAREUR lessons learned cell could have provided on site assistance but they were not deployed to do so. Instead, the G3 plans had to assemble and produce the IID after action review and lessons learned as another duty assigned while still being actively involved in on-going operational planning activities. An operations analysis branch similar to the one used by the ARRC to

conduct soft analysis, such as return to normalcy indicators and village assessments, would have benefited the G3 plans shop and could have been used for lessons learned documentation as well. Use of civil affairs to provide such a soft analysis capability might be worth exploring in future operations.

National priorities and interests were major factors to be considered in the course of action planning and execution. NATO and national policies and interests, including the United States, often differed on critical issues. In this regard, commander TFF guidance from higher headquarters was plentiful, but sometimes conflicting, and placed the commander in a difficult situation, especially if the higher headquarters commander wore both U.S. and NATO hats. Nations could and did play their red cards blocking actions or refusing to participate in operations. One famous example of such an action was the ARRC commander, British General Sir Michael Jackson's reply to General Clark, SACEUR, and his superior in the SHAPE chain of command. Clark ordered him to block Russian access to the Pristina airfield at the outset of the deployment into Kosovo. Jackson replied, "I'm not starting World War III for you." The UK government backed him up when London, through his national chain of command, ordered him not to comply with the Clark order. In other cases, national policy and strategy was not clear and this uncertainty added challenges to the commander's planning and execution on the ground. For example, concerns about the clarity of U.S. National Command Authority policies introduced some planning uncertainties for the U.S. commander on the ground. There was also a feeling that "on the ground situation awareness" was lacking at the policy and higher levels of command. Commanders on the ground also felt they needed to be given a better working knowledge of higher headquarters positions, initiatives, and related critical issues that affected their operation and plans. The boundaries between strategic, operational, and tactical were blurred, making the need to bridge the information gap among the key participants all that more important.

The informal network proved to be an essential means for working around command level disconnects, helping to deconflict actions, and providing information in a timely fashion. Responsiveness and flexibility were key attributes of the shadow operation. The command was under a fine microscope and when something serious happened there was an instant demand for information that needed to be filled and filled quickly. Under these circumstances, it was important to inform upward quickly and the resulting tasking from above and command response process

needed to be carefully managed in order to avoid unnecessary overloading of an already busy staff trying to solve the problem. Many times the early field reports on a serious situation were incomplete and in some cases incorrect, so it was important to allow some time to assemble a reasonably clear and correct picture of the incident on the ground and then engage as necessary.

There were two collateral level video teleconferences (VTC)s with USAREUR every week, one on Wednesday for a Balkans update for the Deputy Commander, USAREUR, and one on Friday which was an O-6 level meeting chaired by USAREUR. The USAREUR liaison officer at MNB(E)/TFF was the main conduit to USAREUR for issue actions. The TFF ACE held weekly SCI VTCs with the USAREUR DCSINT and ACE in Heidelberg, Germany, and with the Joint Analysis Center in Molesworth, England. The National Intelligence Support Team held a weekly SCI VTC with the U.S. Balkans Task Force in Washington D.C.

There were no MNB(E) VTCs with NATO, SHAPE, KFOR, the other MNBs or UNMIK. There were a few VTC activities in addition to those noted above but generally speaking its use in TFF operations was not as dominant as its use in Bosnia and the air war over Serbia, where VTCs were used daily by the Commander and his staff. For example, in Bosnia there were daily VTCs between SHAPE, IFOR/SFOR and the MNDs and throughout the day other elements such as the U.S. and NATO IFOR/SFOR organizations used the VTC frequently to coordinate related implementation, operation, and maintenance activities. During the air war, General Clark used the NATO and U.S. secure VTC capabilities daily to communicate and coordinate air operations with his Allied and U.S. commanders who were dispersed throughout the European theater and in CONUS.

Coordination among the MNB(E)/TFF headquarters staff was also a challenge due to the fact staff and organization elements were distributed throughout the TOC area as well as other locations on Camp Bondsteel. The TFF battle rhythm established regularly scheduled meetings such as the BUB, the morning intelligence briefing, the targeting meetings, the information operations working group, the command and staff meetings, and others. These were good opportunities to bring staff together, provide information or training, and enable discussions after the briefings or meetings. Daily and weekly staffing meetings among elements such as PSYOP and civil affairs were used to

keep each other informed. Ops-Intel and other information were posted on the SIPRNET and NIPRNET Task Force Falcon Web sites and there was a wealth of information available. There was so much information that the issue quickly became one of better discovery tools to help find the information needed. In fact, there was a need for the equivalent of a Chief Information Officer to help manage the information processes and capabilities of the task force, including external interfaces with KFOR, the other MNBs, UNMIK, and the NGOs.

The TFF Chief of Staff employed a number of techniques for creating an environment for mentoring, educating, sharing, and focusing the efforts of the staff. In spite of these efforts, there still were junior officers at all levels of the command that expressed concern about micromanagement and insufficient mentoring. The COS also held nightly meetings with the G3 staff (without the G3) to review planning activities. He hosted the weekly executive targeting meeting and humanitarian assistance board; he had a weekly chief of staff call where staff principals provided updates on important actions and concluded with his theme of the week, special emphasis areas, and hot topics. Once a week, he hosted an informal command level staff dinner at the DFAC as a team building measure.

Tactical Operations Center Support Systems

The BUB was held in an amphitheater-like room that was quite large and was used for other meetings such as the command and staff, operation after-action reviews, awards and promotion ceremonies, and for the crisis action cell (CAC). There were two BARCO projectors hung from the ceiling that projected onto screens at the front of the room and there were two elevated large screen televisions at each side of the front of the room. A control room in the back directed the use of the projection and sound systems. The control room was quite sophisticated and could mix various audio and video sources to be piped over the sound system and projected on the displays. Video feeds from Hunter, Predator, JBS, CNN, AFN, VHS tapes, computer outputs (source for the BUB slides), and other sources could be individually or simultaneously directed to any combination or all display capabilities. CDs, tapes, microphones, and other sound sources were selectable as well. The commander and his principals, including the multinational commanders assigned to MNB(E), sat at a long table at

the front of the room and behind them rose several rows of seats also equipped with telephones that were occupied by representatives of the various headquarters elements, e.g., G-staff, JIC, SJA, Chaplain (passed out candy, offered a prayer and thought of the day at every evening BUB), PAO, CA, PSYOP, MSU, ALO, and others.

In front of the commander's table was a map table that was used by the CAC when it was set up in the BUB. The commander's table was pre-wired to give the head table SIPRNET, NIPRNET, MSE, UHF TACTSAT, and other access when needed and could be configured in 20 minutes or less to support the establishment of a CAC. A hotline to the ACE and radio access to the LNO, CMD, CONOPS, and FSE nets could be activated as well. There were direct tactical phone accesses to the tactical voice switched network. There was DSN access for camp-to-camp and intra-base communication, DSN access to MSE, and direct DSN access to CONUS and Germany, and a KPN phone for access to KFOR headquarters. There was MSE access to DSN for camp-to-camp and direct access to Germany and CONUS. Motorola radios and handheld radios were also used. When a CAC was set up in the BUB, the Hunter, or other video was displayed on the two large screen televisions and the map board was raised. One of the front screens one showed an Excel spreadsheet with events as they occur, and a map overlaying the location of events was projected on the other screen. The BUB essentially had access to all communications and information system capabilities supporting the TOC.

Although advanced U.S. C2 and planning capabilities, such as GCCS, were available in the TOC area, the staff, including the operations center, generally did not use them. Instead, the processes and tools were more manually oriented with stand alone workstations used for planning, butcher paper used for tracking daily events in the operations center, and 1:50,000 wall maps with acetate overlays used to display operational information.

NATO did not provide secure VTC capabilities for use by KFOR and the MNBs. The U.S. provided MNB(E) with both collateral and SCI level secure video teleconference capabilities for U.S. use only. The SCI VTC was located in the Analysis and Control Element area and the collateral VTC was located in the TFF command section area of the TOC.

There were high-end workstations connected to the U.S. SIPRNET and NIPRNET for the exchange of Ops-Intel and there were other information sources such as the Internet that supported civil-military operations, open

source intelligence, and other needs. A NATO-provided CRONOS (NATO Secret) workstation supported access to NATO Ops-Intel and access to the NATO Intel dissemination network LOCE. Unfortunately, although the NATO terminal was located in the G4 area of the TOC, its physical location did not lend itself to ready access during G3 planning activities. A NATO-provided KFOR Secret Network (KSN) workstation supported access to KFOR Ops-Intel information and it was located in a back room in the G3 plans area, only a few knew about its existence. Needless to say, the NATO provided Ops-Intel information network accesses were rarely used to support day-to-day MNB(E) operational planning.

There were other information system capabilities including collaborative planning tools and state-of-the-art analysis and common operational picture capabilities. The TFF staff used both laptops and workstations for building complex color briefings and there were color printers for producing hard copy handouts. Generally speaking, however, the TOC staff was not exploiting the advanced technology capabilities available to them. The information support tools actually used were pretty basic such as 1:50,000 maps with acetate covers either on a table, hung on walls, or attached to large wooden frames. Grease pencils were used to draw on the acetate to portray the actions of the past week and provide other information for operational planning purposes. In fact, for the targeting sessions there were three large wood framed maps that were used for operations planning and briefing the commander. One portrayed the past week's activities, a second the next week's activities, and the third a 1-week-out projection of events and focus. A laptop connected to a projector was also used to display operations planning briefings on the wall as the plans were being developed by staff sitting around a collection of tables that served as the G3 plans cell work area. Briefings for the commander, COS, and others were held in this area as well. The aim was to keep briefings simple.

In order to improve Blue Force tracking in the operations center, the C2PC system was being installed in the TOC to exploit the OMNITRAC/DTRAC position location system installed in many of the vehicles and used to track their location when on mission. More than 400 vehicle-mounted OMNITRAC's and 41 DTRAC systems were on hand. GPS receivers were also installed on some vehicles and handheld GPS receivers were also used for navigation along Serbian border areas. The OMNITRAC automatically transmitted the vehicle location about every 5 minutes via a satellite gateway access to the NIPRNET and

then through a guard gateway to the SIPRNET and then to the C2PC workstation that displayed the vehicles being tracked on a map. C2PC could also be used to display the air picture but was not being used for this purpose.

The air picture provided for use by the operations center was downloaded from the CAOC using FAADCS system and a STU-III DSN dial-up connection. There was a slight problem in maintaining continuity with this arrangement because a low precedence level was assigned to the DSN connection to the CAOC and as a result of high precedence traffic, it experienced frequent disconnects due to preemption. The FM broadcast could be used to send the air picture to laptops in the field and the air picture could also be sent to MANPAD radios and the laptops of deployed forces. Early warning was also via voice FM communications. There was also access to AWACS JTIDS but there was a line of sight communications problem that interfered with transmitting the signal to the TOC. The problem was caused by shifting the AWACS orbit from Kosovo and to over the Adriatic where transmission over the mountain ranges to Camp Bondsteel was poor.

The Automated Mission Planning System was used for helicopter mission planning. In the TOC alone, there were other stand-alone information systems for tracking mines and UXO clearing status, fire support planning and operations, and other planning and operations tracking activities in the operations center. There were numerous other stand alone computer systems spread through out Camp Bondsteel such as those used by the ACE/NIST, engineers, staff weather operations, SOCCE, public affairs, PSYOP, and combat camera product development facilities.

Other TOC communications consisted of FM nets supporting the ALO, CONOPS, TFF Command, TF FS, and Unit Command. The TOC antenna tower did not allow for proper separation of antennas and this caused interference for adjoining command nets. There was also MSE, DSN, STU-II(B)/STU-III, KPN, S/C TACSAT, and a Motorola base station. Although the communications capabilities were reasonably well documented by the TFF G6, a similar level of documentation of information systems was lacking. This was most likely because there was no equivalent of a chief information officer to manage the configuration stand-alone and networked capabilities employed by the various disparate elements that supported the TOC.

Transfer of Authority

The transfer of authority (TOA) from 1st ID to 1st AD was scheduled for June 20 and this also required the careful attention of the TFF commander and his staff. In spite of the enormity of the effort, the TOA went off without any major hitches. The only noticeable evidence that it was taking place was the increased number of personnel on Bondsteel and increased vehicle traffic as the new replaced the old, and then the rehearsals and the actual TOA ceremonies. BG Sanchez, at his last BUB the night before the TOA, thanked the staff for their contributions. He said, “Kosovo was an enigma and that we brought values these people didn’t understand.” His final guidance was to “be evenhanded and treat everyone with dignity and respect.”



Figure 2. Transfer of Authority Ceremony

The TOA ceremony was held on the newly constructed gravel parade ground next to the TOC with a view of the Sharri Mountains in the background (see Figure 2). MNB(E) soldiers from the U.S., Greece, Poland, and the Ukraine stood in formation and displayed regimental colors. The ceremony started at 9 a.m. and lasted about an hour. LTG Juan Ortuno, COMKFOR, symbolically transferred authority by handing over the Task Force Falcon flag from General Sanchez to General Tieszen. There were a number of dignitaries including LTG James Riley, Commander V Corps, and Ceku, commander of the TMK/ KPC.

In an interview after the TOA ceremony, General Tieszen told the press that peacekeeping comes down to what he referred to as “The Three Fs. Be Fair, Be Firm, and Be Friendly.” Tieszen also told the reporters, “It’s very important that we be evenhanded and fair. Firm but friendly. And that’s what we will do.” He was tested a few days later with a riot in Strpce.

At his first BUB the evening of the TOA, General Tieszen provided guidance for the next 30 days. His goals included:

- Setting standards and enforcing them;
- Getting settled into sector and considering TTP adjustments;
- Engaging the population and generating a rapport;
- Reviewing missions and determining what changes were necessary;
- Looking at the quality of life and force protection for remote sites (we had 40);
- Working on systems and processes;
- Developing a personal battle rhythm (read a book and do physical training);
- Maintaining current HQ battle rhythm; and
- Maintaining alertness on safety and security.

The 1st AD team started off with a somewhat internally focused tough-guy attitude that gave the impression that things were going to be a lot different from the 1st ID operation. As a result, there were some tense moments over the following few days and weeks as the new senior level players competed for leadership positions and the new team adjusted to the operational environment. The team building dynamics of storming, forming, and norming were all observed as the new team came together. Since trust and confidence had to be earned, it took some time to integrate existing staff and the new arrivals into the 1st AD team. The most noticeable changes were related to a less stressful battle rhythm and op tempo and, *Iron Soldiers* replaced *Duty First* as the motto of the day.

The battle rhythm of the 1st ID that had been driving headquarters' operations was immediately disrupted with the TOA to the 1st AD. Meetings and events were suddenly not as predictable in terms of when they would occur and how long they would last. There were changes made to the battle rhythm over the next several months that refocused activities, streamlined processes, balanced external with internal requirements, and afforded the staff some down time on Sundays. A 2-week cycle replaced the 1-week of intense activities—for the new battle rhythm, 1 week focused on staff activities related to targeting and the other week on the commanders.

The headquarters' op tempo certainly slowed down, starting on day one—the high activity G3 plans shop essentially closed down in the evening and was quiet even during the daytime hours. As the factions tested the 1st AD team and they became more sensitive to the environment, the team and operation began to stabilize, but this took several weeks. The frequent turnover of commanders and the 6-month unit rotations created significant turbulence and challenges in both the leadership and continuity of operations for KFOR and the MNBs. In the time leading up to my arrival in May 2000, there had been three MNB(E) commanders and before the end of July there would be two more. In Bosnia, it took more than 2 years to see a similar number of commanders for the U.S.-led contingent. The seemingly revolving U.S. command door raised concern on the part of some that maybe careers and administrative requirements were being put above getting the mission accomplished. After all, the Kosovo peacekeeping mission was work in progress and the Army's most important and visible mission at that time.

KFOR and the other MNBs experienced similar cycles of force rotation but not necessarily the same frequency of commander turnovers. There had been three COMKFORs in the first year of operation and a fourth would take over in October 2000. There were also NATO and SHAPE level turnovers in this same timeframe. The Chairman of the NATO Military committee changed in May 1999, the NATO Secretary General changed in October 1999, and then in May 2000 SACEUR changed from Army to Air Force with General Ralston, U.S. Air Force, replacing General Clark, U.S. Army. These represented significant changes from the highest levels of NATO command down to the levels supporting the NATO Balkans operations and the Kosovo deployment in particular.

The rotation of military personnel was a problem in the Multinational Brigades, especially at the tactical level. Civil-military trust relationships earned over time were interrupted every time a new team rotated into the CA/CIMIC, PSYOP, and maneuver units. In MNB(E) the rotations occurred every 6 months. Units such as civil affairs and PSYOP rotations overlapped the maneuver units and this, fortunately, accommodated some continuity of operation. Even here it was necessary to reestablish trust and rebuild the team when new units deployed. Attempts were made to facilitate the transition by reassuring the local leaders and residents nothing would change in the relationships with the shift in personnel. However, opportunities were missed. New civil affairs and PSYOP teams and others such as the MPs and maneuver units had to be careful that they did not get drawn into situations based on locals saying the previous team promised them something or that the military would do it for them. A civil affairs' rule of thumb was to never promise anything.

Joint Implementation Commission

The MNB(E) Joint Implementation Commission (JIC) facilitated communication between the task force commander and the parties in order to ensure overall compliance with the provisions of the MTA and UNMIK Regulation 1999/8 regarding the establishment of the Kosovo Protection Corps (KPC). LTC Ingram, U.S. Army, and MNB(E) JIC, had a staff of one officer and two specialists first class and a contract translator. He reported to the commander TFF through the Chief of Staff. For movement around the sector he had a Montero SUV and a Humvee with secure communications. He also used Motorola *TalkAbout* handheld radios.

As the JIC, LTC Ingram served as the MNB(E) LNO to the KPC, supervised the activities of the training advisory team to the KPC, monitored KPC-related international agreements and implementation activities in sector, and held meetings with KPC leaders and key staff personnel. For example, in response to the construction of a UCK monument in Kamenica, the JIC worked with the KPC leadership to try to get their support to have it taken down. There were NATO officers with Partnership for Peace and U.S. Army Reserve CA forces that had military-to-military mission experience that could have been ideal consultants to the KPC under JIC guidance. Yet, very few of the former and none of the latter were ever assigned to them. There was no institutional involvement

of KFOR J9 with the KFOR JIC in the conversion of the KLA into a civil emergency preparedness and disaster relief type organization. Likewise, the MNB(E) G5 was not involved either.

The MNB(E) JIC served as Secretariat to the MNB(E) Joint Security Committee and attended and facilitated weekly meetings on sector security with representatives of the international community, including UNMIK. He actively interfaced with the KFOR JIC, TFF battle Commanders, and the MNB(S) and MNB(C) JICs. He had contacts with the UNMIK regional administrator, Gnjilane, UNMIK Police in the Gnjilane region, and with the International Organization for Migration (IOM) offices in Gnjilane and Ferizaj.

In an interview with the former MNB(E) JIC, LTC Wiseman, U.S. Army, before he left, he expressed some concern about the rate at which the UCK was disarmed and UNMIK was trying to transform them into a FEMA like humanitarian assistance organization. His concern related to whether this would work in the long run. After all, the Albanians viewed the TMK/KPC (formerly the UCK/KLA) as the liberators and the KPC viewed themselves as the Army of Kosovo. In spite of the potential problems related to power positioning, the Task Force Falcon commander was trying to work with them, but was firm as well. The stated mission of the KPC, as established by UNMIK, was to be the only multidisciplinary, multiethnic, indigenous emergency service agency in Kosovo. They would react to disasters affecting the population and territory, conduct search and rescue operations, and assist in rebuilding the infrastructure and community. The KPC would also provide assistance to UNMIK and KFOR and perform ceremonial duties such as TMK/KPC leadership (see Figure 3) attendance at the June 2000 MNB(E) TOA. They would not, however, have a role in law enforcement, riot control, counterterrorism, or any other task that involved the upholding of law and order. Members were also not to participate in political activities, hold public office, or actively take part in political affairs.



Figure 3. TMK Leadership

The KPC structure consisted of six regional headquarters, one for each of the five MNB regions and one for the Drenica area, with the headquarters located in Pristina. There were three to five detachments per region and an honor guard and rapid reaction group that would be able to be committed anywhere in Kosovo. The KPC would consist of 5,000 personnel with 3,000 active at any given time. The pay ranged from 150 to 700 DM per month (for a comparison, local hires working at the PX on Camp Bondsteel earned about 650 DM per month). They were allowed 2,000 weapons but no more than 200 could be used at any one time. Ten percent of both active and reserve members had to be comprised of ethnic minorities, but there were no Serbian members in June. On any given day, 75 percent of the KPC members were idle. Typical activities that they were used for included school repairs and renovation, road improvements, water system repairs, city parks and sports field construction, and abandoned car removal.

The demilitarization of the KLA was viewed as one of the major UNMIK and KFOR accomplishments in the first year of Operation Joint Guardian. Few post-war guerrilla armies have agreed to disband and surrender their weapons as the KLA did. Few believe, however, that the KLA's disarmament has been complete. KFOR has found weapons with linkages to former UCK/KLA members that support this observation. In mid-June, KFOR Operation Leatherman in the Malisevo region led to

one bunker containing 67 tons of weapons and explosives and documentation linking them to the KLA.

The KPC also suffered from a chronic lack of international support. It was not included in the regional Kosovo budget and financing was dependent on contributions from a few interested nations. The hand-to-mouth approach did not help maintain the independence of the KPC, some of whose members were suspected of engaging in intimidation and corruption. If the international community wished to resolve the possible corruption problem then it needed to ensure the KPC that the members would be given a decent wage and provided the training and equipment necessary to carry out their assigned mission. It should be noted, however, once Kosovo-wide government structures have been chosen through democratic elections, it will be difficult for the international community to avoid the issue of the formation of an Army in Kosovo and the role of the KPC in this regard.

Some Operational Realities

Maintaining a safe and secure environment was the primary military mission. However, MNB(E)/TFF also assisted with the further development of Kosovo and reestablishment of essential services throughout the U.S. sector. MNB(E) units adopted schools and facilitated spring planting through the delivery of seed, fertilizer, and fuel. Over \$3.4 million of Department of Defense (DoD) humanitarian assistance funds were provided to rebuild schools, public utilities, and health care facilities. TFF also coordinated and facilitated the restoration of electrical power and telephone services, especially to the Serbian enclaves. As KFOR's first anniversary approached, MNB(E) began to experience increased ethnic violence in its sector as well as hostilities along its border with Serbia, particularly in the Presevo valley. In spite of these renewed hostilities, TFF continued to support UNMIK, NGOs, and other efforts of international organizations to restore fundamental public services and lay the groundwork for the eventual transfer of functions to the appropriate civil institutions.

One tactic for combating hostilities was the cordon and search operation. These operations were carefully planned and rehearsed before being executed. Each operation had clearly defined objectives and contingency plans. Soldiers reviewed extensive reference material before the operation,

including photographs of people, buildings, and access areas. Search teams needed to be creative since these folks have been hiding weapons for years and were pros at it. Soldiers from other districts conducted cordon and search operations so that the locally stationed units could maintain a good rapport with the civilians. These operations, because they were invasive and disruptive, were followed immediately by resumption of normal operations and by PSYOP and civil affairs team visits. The locals needed to understand that this would be part of the normal way of life if they didn't cooperate—the units would never apologize for a search, and the residents would normally be supportive as long as they saw that it was fair and evenhanded.

TFF faced numerous challenges at the tactical, operational, and even strategic levels in executing its command, control, intelligence, and other support responsibilities. The lack of a clear national and international policy, strategy, and goal for Kosovo complicated the U.S. commander's planning and execution on the ground. Although labeled a brigade, TFF was really operating at a higher level with U.S. division-level augmentation and non-U.S. elements that needed to be integrated into the operation as well. For a number of reasons, the task force was not adequately provisioned (manpower and expertise) to perform the many and varied missions. There was a feeling that peacekeeping deployments tended to depend more on political limitations rather than on an analysis of the requirements for success. Therefore, TFF had to be more creative in using its limited resources to meet its mission responsibilities that in many cases were as, if not more, demanding and complex than those encountered by Task Force Eagle (TFE) in Bosnia.

Proper maps continued to be a problem in spite of NIMA efforts to do better. One creative response to the map problem was the replacement of the military maps with tourist maps. The military maps provided were ill-suited for use in urban operations because of their scale and lack of detail. For example, military maps of Gnjilane only showed the main routes, so the maneuver units and foot patrols had to use tourist maps of the city. Civil affairs helped find some local large-scale maps that showed every street. Topographical maps provided for counter-insurgency operations on MNB(E) borders were also inadequate. Soldiers obtained Serbian maps of the mountains that provided the detail they needed. The absence of grid locations on the substitute maps necessitated the use of GPS receivers by deployed units to provide

accurate position location as they moved about the sector and along the borders.

Kosovo was largely a policing operation for which the military was neither properly trained nor fully equipped to support. MPs were certainly trained for policing skills and civil riot control including the use of non-lethal weapons when approved by COMKFOR. The multinational specialized units, such as the Italian Carabinieri, provided expertise in these areas as well, but organized crime and criminal investigation expertise were still lacking. There was an urgent need for organized crime expertise and the MPs had to teach many of their own people how to be basic investigators. Non-MP military personnel were not trained in crowd control techniques, yet crowd control was often one of the most dangerous duties they had to perform. Training for many of the units occurred after deployment into Kosovo. Riot gear was also not readily available for all units. Some soldiers were supplied with older gear that could not withstand an actual riot control situation, resulting in shattered face and body shields and injury to KFOR soldiers.

In order to restore the local governments, OSCE began registration for an election scheduled for the fall of 2000. Registration facilities were established in both Albanian and Serbian communities, but a boycott severely lowered Serbian participation. Fear of personal safety remained a concern for the Serbs. Registration sites were set up on the border with Serbia, but this did not help. Additionally, many of the Serbs remaining in Kosovo were pensioners who received their monthly payments from the Belgrade government. Threats were made to stop pension payments if they registered, which had an adverse impact on Serbian registration. UNMIK police guarded the registration facilities and no violence was directed against these facilities. For those who did register, the registrants had to provide proof of identity and were then photographed and fingerprinted to produce identity cards.

There was a general feeling that TFF requests for U.S. resources were constantly met with resistance. For example, a longstanding TFF request for a Department of Justice multidiscipline criminal investigation team with European and international organized crime experience was still unanswered at the time I visited. On the other hand, in terms of U.S. ADCON and Title X support, TFF received excellent support from USAREUR and USEUCOM. Additionally, 1 ID and V Corps filled many shortages for short-term resources and staff personnel to tackle key

issues and conduct planning, but these addressed the symptom and not the problem. The fact remained that the expertise that resided within the brigade staff was neither equipped nor experienced enough to tackle the complex strategic and operational issues that MNB(E) had to wrestle with each day. Complicating the situation was the fact that over time, the missions were expanded significantly beyond maintaining a safe and secure environment and included activities such as dismantling organized crime and counterinsurgency operations on its borders. Other MNB(E)/TFF resources were increasingly being diverted to support civil-military assistance activities to fill gaps and shortfalls in UNMIK capabilities and this created additional resource shortages.

The young men and women of the U.S. Armed Forces and the civilian contractor workforce supporting TFF were hard-working, dedicated soldiers and civilians trying to serve their country with dignity and pride. They did so under trying circumstances and sometimes at great personal sacrifice. I was constantly amazed by their accomplishments and I was reminded that nothing was easy to do in Kosovo. Remaining patient and managing expectations became an important part of their daily routine.

CHAPTER XX

Intelligence and Situation Awareness

Larry Wentz

Intelligence

The intelligence setting for KFOR extended beyond the Kosovo and MNB(E) boundaries into the neighboring countries of Former Republic of Yugoslavia, Former Republic of Macedonia, Albania, Montenegro, and Bosnia. In fact, for the U.S. as the sole superpower, intelligence had global implications. The MNB(E)/TFF intelligence team had to cast a wide net, far beyond the theater of operation, to grasp the influences in the area. The boundaries between strategic, operational (theater), and tactical intelligence were not only blurred, but overlapped significantly. Tactical level intelligence was needed at the strategic level and strategic (political) level intelligence was needed at the tactical level. A strategic-tactical level big picture needed to put together to meet the situation and mission awareness needs of the commander on the ground. In fact, total mission awareness had to be pushed not only to the brigade, but to levels of command below brigade as well.

Peace operations intelligence doctrine and tactics, techniques, and procedures such as those set forth in FM 100-23 and Joint Pub 3-07.3, are maturing but not yet adequate for multinational operations. Military intelligence doctrine focuses on fighting an enemy whose doctrine is known and understood, but for peace operations such as Kosovo, the enemy was not clear. Furthermore, there was no doctrine to target, but rather tendencies that evolved over time. In order to be successful in peace support operations, it is also important to be able to understand the culture you will be involved in, to know who the local decisionmakers are, and to have an understanding of social issues. The military did not have a complete understanding of the cultural aspects at the outset of the operation. Developing an appreciation of

cultural sensitivities continued to be a challenge for each new rotation of forces.

Putting the Kosovo intelligence picture together at the outset of the operation was not an easy task, in spite of the fact that there was a considerable amount of Balkans experience in the U.S. and European intelligence organizations and military commands. For example, the 66th Military Intelligence Team in Europe had analysts that managed target sets on the Balkans daily. This provided critical continuity for U.S. Army intelligence activities in theater, but this was only part of the picture. Overhead imagery did not tell the whole story at the outset of the operation. The military tensions and civil situations in Kosovo, coupled with the speed with which the decision was made to introduce ground forces, precluded conducting a proper reconnaissance of the area or putting intelligence forces on the ground in advance of the major deployment. There were no standard templates for structuring intelligence support for peace operations, so the military had to adapt those used for wartime operations. This also required an intellectual adaptation to the new and complex peace operation environment. The intelligence needs of KFOR and the related coalition reporting procedures, information sharing criteria and methods, and national responsibilities were only broadly addressed. The nature and intensity of a potential threat could change suddenly, so the intelligence resources needed to be flexible enough to aggressively adapt to changing requirements. The intelligence effort needed to be unified through the integration of resources and capabilities across all levels, including the multinational partners as they joined the task force. Sharing and mutual support were key to being able to integrate resources and capabilities into a unified system to satisfy the ever changing needs of the combined operation.

The intelligence preparation of the battlefield (IPB) was a continuing process and it took time to properly characterize the overall environment. Early versions of the IPB fell short in their characterizations of the non-military aspects of the environment, such as the ethnic situation of cultural hatred, the socioeconomic situation of clans and organized crime, as well as attitudes among local leaders and civilians towards the foreign military presence. Further complicating the situation was the fact that the front line of the peace operation battlefield was 360 degrees wide.

Strategic guidance and a definition of a clear end state for Kosovo were lacking. Kosovo was a non-traditional intelligence environment that had a heavy emphasis on asymmetric threats and capabilities. In order to accommodate the situation, Task Force Falcon intelligence activities needed to modify traditional U.S. Army intelligence doctrine. Traditionally, operational needs and courses of action determine priority intelligence requirements for decisionmaking by the commander. In Kosovo operations were driven by intelligence that was available. The TFF G2 identified the threats to a safe and secure environment and the commander issued priorities for intelligence collection based on the threat, directives from higher headquarters, and political considerations. The collection manager allocated assets based on the commander's priorities and the intelligence section attempted to fuse the information collected into actionable intelligence.

It was difficult to collect and exploit the full range of information, identify indicators, and provide predictive analysis, especially since TFF operated in a reactive mode. The process required robust intelligence collection and soft analysis capability, which were lacking. There was also a shortfall in predictive analysis, but then this was not surprising since today's U.S. intelligence systems and doctrine favor data collection at the expense of analysis. Furthermore, intelligence system acquisitions are built around platforms. The task force intelligence operation was a difficult job and the non-traditional collection and soft assessment demands exceeded the experience, expertise, and capabilities of the personnel assigned. Since the outset of the operation, the characterization of the complex environment matured to a point where a reasonable understanding of the belligerents and of the non-military aspects of the environment existed as parts of situation awareness. Maintaining the situation awareness and transferring insights across each 6-month rotation of forces was a challenge and the process was not perfect, but did improve.

The MNB(E)/TFF intelligence operation was a challenging round-the-clock, high op tempo activity. They had to be able to collect and conduct traditional hard targeting-based analysis supporting military courses of action related to maintaining a safe and secure environment and countering insurgency activities on MNB(E)s borders. Intelligence also had to be able to collect and conduct softer analysis of the political and local organization intents, economic needs, civil unrest, vigilante and rogue capabilities and intents, election support needs, refugee

movements, international and non-governmental organization activities, revenge violence, civil infrastructure strengths and weaknesses, and organized crime. Further complicating the situation was the fact that intelligence was traditionally collected to answer specific questions about an operation the military had decided to undertake. In Kosovo, intelligence and information were collected in order to determine when, where, and how to act, which was a different approach.

The Task Force Falcon U.S. military maneuver commanders discovered quickly upon arrival that they would need to create their own collection and analysis capabilities to develop a knowledge base which would allow them to take effective action against the belligerents. The initial focus was to collect intelligence against all belligerent parties. Everyone that went outside the compound was considered a collector of intelligence and tasked to do so. Target folders were prepared for key towns, population centers, and organizations and individuals with influence. Information was collected on town leadership, political and economic climate, key establishments, and other demographic, infrastructure and terrain information. Because of the high crime rate in the area, it was necessary to develop criminal intelligence capabilities and integrate the military operations into the law enforcement activities of the UNMIK police. This made it important to also be able to analyze criminal intelligence in relation to the evolving social problems and potential for military actions. The information collected was used to create link and influence diagrams and to perform the soft analysis necessary to identify power bases and to develop an understanding of the life and daily operations within the towns of their area of responsibility.

Police information operations were relatively new for the MPs and it was necessary for them to put a plan together that not only addressed the information flow from inside police channels, but also the flow of information collected from non-police units. The MPs and CID formed a crime-analysis cell that sorted through police reports and cases and performed some critical analysis of the information. The efforts were linked with the battalion S2 and eventually with the ACE at Task Force Falcon headquarters. One of the hardest parts of the operation was collecting the information that the infantry, armor, engineer, and other units received from their daily contacts and patrols. In order to improve information collection, the MPs worked closely with the combat-arms units through daily personal contact, emphasizing that even the most

mundane information could be the missing link in a police investigation. They also provided feedback so the combat arms units could see the fruits of their work. Soldiers worked closely with partner nations, such as the Russians, Greeks, Poles, Ukrainians, Swedes, Canadians, British, Germans, and the UAE to collect information from them and provide feedback as well. Civil affairs and PSYOP teams were used to communicate with the public to help mold attitudes and desired behavior and to inform the community of successes in reducing crime. The MP commanders also participated in local radio shows as a way to get their message to the population. Civil affairs and PSYOP were extremely sensitive to being viewed as an intelligence asset. They consciously maintained an appropriate separation from the intelligence element to preserve their credibility and objectivity.

Many of the criminal, ethnic, and paramilitary relationships were found to extend across the Task Force Falcon sector boundaries into other multinational brigades. The belligerents knew the boundaries and operated across and along them where they perceived a weakness or lack of coordination. Exchange of information between multinational military elements at the tactical level became important and it was necessary to develop special arrangements at the battalion and below levels to do this. Joint operations and patrols were also conducted with the multinational brigade units on TFF boundaries as a way to regularly exchange information and develop shared situation awareness. Active inputs from Special Forces and force protection teams, and passive inputs from PSYOP and civil affairs teams were used to help complete the overall intelligence picture or provide greater focus. Once the commanders had a good understanding of how things worked in their area of responsibility and solid knowledge of the belligerents, their tendencies, their strengths, their weaknesses, and most importantly an understanding of their motivation, they were able to shift the focus to developing actionable intelligence. For the most part, the tactical commanders felt they were able to maintain the focused intelligence picture and to stay out in front of the belligerent forces and maintain a safe and secure environment.

U.S. national and theater level intelligence collection and analysis assets were employed to support MNB(E)/TFF, as well as national purpose-built and tactical collection systems to exploit the non-lethal environment. The Task Force Falcon G2 and the Analysis Control Element (ACE), supported by a National Intelligence Support Team

(NIST) and Special Operations Coordination and Control Element (SOCCE), represented the heart of the Task Force Falcon intelligence operation. There was also access to USAREUR DCSINT, 66th MI, EUCOM J2, the Joint Analysis Center and national-level agencies. Split-base and reach-back secure information networking capabilities provided the ACE and others access to intelligence analysts who have been monitoring and tracking the Balkans over a long period of time.

The Task Force Falcon G2/ACE had access to the KFOR intelligence dissemination systems, as well as daily KFOR and MNB INTSUMs. The non-U.S. elements assigned to MNB(E) provided intelligence inputs and support as well. The U.S. NIC at KFOR headquarters was a small operation relative to the Task Force Falcon G2/ACE/NIST capability. There was some interaction and exchange of information with both the U.S. NIC and the KFOR CJ2, who was an appropriately cleared U.S. military officer. There was some cross-MNB sharing, mainly with Britain, but also with the German and Italian intelligence cells at the Task Force Falcon G2/ACE level. At the battalion and lower levels there was an operational need to share tactical intelligence pertinent to activities along the MNB border areas. There was also close cooperation at the tactical level with the British, French, and Scandinavians on signals intelligence collection and sharing. In this case, NSA was quite cooperative in sharing appropriate U.S. signals intelligence with KFOR and the other MNBs.

The intelligence staff mainly integrated the various stovepiped streams of information coming into the TFF operation. They had access to the information available locally and were the only organization that could effectively weigh the importance and relevance with respect to the capability of the commander on the ground forces and operational intentions and needs. It was important for the MNB(E)/TFF commander to have the ability to perform his own assessment of the situation from all potentially useful sources. These sources included U.S. tactical, theater, strategic and national levels, and multinational sources as well. With today's technological capabilities, there were many varied sources of information at all levels, which required a major effort to integrate and assess at the Task Force Falcon level. Herein lies one of the significant challenges, since the sources of information were largely stovepiped with little integration and processing before being sent to the task force. The amount of information that could be disseminated downward as well as from within the task force's own capabilities was

enormous, which many times overloaded the commander and staff due to the lack of tools and resources to process and analyze the inputs. The problem was not getting information to the commander and his staff, but finding useful data and assembling, analyzing, and packaging the volumes of information into actionable intelligence.

Use of the NIST, which had access to the NSA, the DIA, the CIA, and the National Imagery and Mapping Agency, provided agency representatives on the ground to prepare products that could be more directly used by the G2/ACE and commanders. Other split-base and reach-back operations were used as well, which was an effective way to obtain access to the breadth and depth of knowledge, skills, tools, and assessments not available locally. The approach did have some limitations, in that the further away the analyst was from the operation, the more diminished his view became of the sense of urgency and true understanding of the situation and commander needs. The use of the NIST-like teams in the theater for short periods of time began to bridge the understanding gap. The Task Force Falcon analysis and control element even found it necessary to send staff into the field for several days at a time to walk patrols and participate in other on the ground operations, so they could better understand the intelligence needs of the organization elements they supported.

COMINT, IMINT, MASINT, HUMINT, ELINT, SIGINT, and OSINT intelligence collection capabilities contributed to TFF intelligence activities. The military intelligence community provided communication systems, such as JWICS and Trojan Spirit II, which were used to extend secure wide band intelligence services into Kosovo supporting both SCI and collateral secure intelligence-oriented information services. The tactical military and commercial communications systems supporting these intelligence related services were operating at the limits of their bandwidth throughput. JWICS provided SCI level Web based access (INTELINK) to intelligence databases and Web sites worldwide. Deployable intelligence workstations such as JDISS and CHATS (CI/HUMINT laptop) provided the ability to access a core set of intelligence databases and applications at all levels of the intelligence structure. JDISS access was, in fact, the tactical link to the rest of the U.S. intelligence world. CHATS gave the CI/HUMINT community a significant capability but teams using it were not fully trained on its software utilities, and thus could not take full advantage of the power of the capabilities offered. Lack of training tended to be true for other

high tech information systems deployed. Some CI/HUMINT teams were using the older TRRIP system (the predecessor to CHATS) that was employed in Bosnia. TRRIP put HUMINT reports in different formats, complicating the database population in the Kosovo operation. This issue is representative of backwards compatibility problems experienced with the introduction of enhanced versions of a fielded capability into an operational environment that employs a mix of both the old and new versions. The tactical military intelligence all source analysis system (ASAS) was deployed, but found to be marginally useful. SIPRNET provided Web based access to the collateral intelligence databases offered by INTELINK-S. The Mobile Integrated Tactical Terminal was used to process ELINT data. Unmanned Aerial Vehicles (UAV), such as Hunter and Predator, were used extensively. The joint broadcast system was used to disseminate UAV video as well as other imagery and information including weather. Intelligence collectors JSTARS, QUICKFIX, and ARL were not used. The U-2s, AWACS, P-3s, RIVET JOINT, RC-135, Guardrail, AR8000, ground surveillance radars, REMBASS, multinational tactical reconnaissance, combat camera, low level voice intercept (LLVI), helicopter gun camera video, and handheld digital cameras were part of the inventory of intelligence collectors available to the Task Force Falcon commanders.

These intelligence systems have been identified in order to give the reader a feel for the breadth and depth of capabilities available to the commander and his staff without a discussion of their specific capabilities and use. The subject of intelligence systems and how they are used to support peace operations would fill a book by itself.

In addition to combat camera and other sources providing visual documentation of special events, almost every soldier had his own digital camera to take pictures and videotape events. The freedom to take pictures had some downside risks, in that sensitive photos could and did show up on Internet Web sites. Sometimes soldiers wanted to share experiences without proper consideration of the force protection and security implications of making the information available to the general public. For example, sensitive pictures of Camp Bondsteel and the helicopter flight line with pictures of the cockpit showed up on a Web site. From an OPSEC point of view, there was a need to sensitize soldiers to which photos they could take with personal cameras and how they were shared with others. This was a problem because there was no policy on picture taking. The more difficult challenge, however,

was integrating, archiving, and cataloging the information collected. Sometimes the documentation supporting the pictures and videos did not clearly indicate the subject and when and where the pictures were taken. It was also a challenge to make others aware of the availability of information such as the “happy snaps” from handheld digital cameras, aerial photos of villages taken from helicopters and the content of videotapes from UAVs, P-3s, gun ship cameras, and handheld cameras. Combat camera units were an exception. After every mission they would post pictures on their Web site for authorized access and they also archived still pictures and videos for other uses as appropriate, e.g., PSYOP used combat camera pictures for posters, newspaper ads, and handouts supporting the MNB(E)/TFF information campaign. The analysis and control element, and other intelligence activities used combat camera photos and videos for assessments and constructed target folders on key people, places and things.

Dissemination of intelligence products was a challenge, especially to the soldier at a remote site in the field who only had a SINCGARS radio. Because of the mountainous terrain it was difficult, and sometimes impossible, for headquarters to maintain voice contact with deployed units. These deployed units made weekly visits to higher headquarters to review the intelligence files. The forward-deployed forces also monitored company and battalion headquarters command radio nets for special intelligence reports. Higher headquarters frequently distributed CD or hard copies of INTSUMs and other information to the forward-deployed units. These were often the only ways to get the information to those who needed it in the field. At remote outposts, such as the Eagle’s Nest, a counterinsurgency operation, the platoon leader told me that he got together frequently with his foreign counterparts to conduct joint patrols and share information, in addition to his weekly visits to higher command headquarters for intelligence updates. During a visit to Letnica, there was an U.S. Army platoon monitoring activities in the area. They said they generally got their intelligence updates once a week when visiting company headquarters and they also monitored both company and battalion radio nets for special intelligence alerts.

Deployed units also experienced problems getting timely and reliable information on suspects at road and border checkpoints. Requests for information to the company level were not answered quickly since the suspect databases resided at the battalion level and an additional request

needed to be filed. This process sometimes suffered from the parlor game problem in that requests and subsequent replies were passed by voice from one level to the next with errors introduced, which reduced the value of the information eventually provided to the soldiers.

The U.S. Defense Information System secure data network, referred to as SIPRNET, can now be extended over military tactical communications systems to serve operational units at the tactical level. SIPRNET access was extended to the U.S. battalion level and to the U.S. intelligence support teams collocated with non-U.S. elements, such as the Russian 13th Tactical Group in Kamenica. There was also a U.S. Army signal brigade that provided a contingency operations (CONOPS) tactical communications package that could be deployed on short notice that extended SIPRNET, the non-classified Internet protocol router network (NIPRNET), and secure phone and video teleconference services to support special tactical operations. For example, the CONOPS package was deployed to support the MNB(E) force deployment to Metrovica during the riots. It was also used to extend morale, welfare, and recreation (MWR) services to remote outposts such as the Eagle's Nest. Such deployments not only facilitated information support to operations, but also allowed soldiers at remote locations to make phone calls and e-mail home, surf the Internet, view current movie releases, and in some cases to even have a video teleconference with their families at the home station in Germany. The CONOPS package was road transportable and once onsite could be operational in less than 2 hours. While visiting a CONOPS deployment to Eagle's Nest, the platoon leader mentioned that in addition to problems related to getting intelligence to recently deployed units, the U.S. maps provided to him for his area of responsibility were not as good as some Serbian maps he had acquired. Detailed maps have been a continuing problem in operations and NIMA has been constantly trying to improve the maps it makes available to the forces. Release of NIMA maps to non-U.S. elements was a challenge as well. The UNMIK police criminal analysis team in Pristina was trying unsuccessfully to get maps for use in their criminal analysis and profiling activities.

There were some non-U.S. intelligence collection systems that were used in the MNB(E) sector to help with special collection needs. One such system was the Canadian surveillance system COYOTE that was used to monitor smuggling routes and activities in the Presevo Valley. The system was mounted on a military vehicle and had a 30-foot telescopic radar antenna and a video camera with thermal optics

capabilities. The radar had a range of 24 km in good weather and could identify a vehicle at a distance of 7 or 8 km. Using two observation posts, the COYOTE system could cover an arc 20 km long. The video camera had a 20x zoom lens. Anything that penetrated the arc alerted the operator and the COYOTE system would give him the distance, direction, date, and time. With the click of a button the situation could be video recorded or sent in real time to higher headquarters.

The U.S. Army's Hunter UAV was a true workhorse and a valuable asset to the operation. It was used everyday, weather permitting. The aircraft was a giant radio-controlled plane, 23 feet in length, a wingspan of 29 feet, weighed 1,600 pounds, and flew at 10,000 feet with a range of 288 nautical miles or 12 hours in flight. Two pilots, one on the runway and one at a control room at the Skopje military operations base, worked in tandem through various portions of the flight using a remote control and global positioning device. The pilot on the runway visually flew the UAV from take off to 2,000 feet and then upon return from a mission took over for landing. At 2,000 feet the pilot in the control room took over the aircraft for the duration of its mission. One of the key target areas was the Presevo Valley. While on station, a two-person team in Task Force Falcon ACE directed the mission and identified target areas to be covered. A secure military mobile subscriber equipment (MSE) voice link from the analysis and control element to the control room at Skopje was used to communicate with the pilot who guided the UAV. Analysis of the Hunter video was an art, which was handled by a contractor. The contractor did a very good job, but it was a missed opportunity for the military to develop expertise in this area. Mission planning usually took 48 hours but could be adapted while in flight if necessary. During the mission, commanders could watch live video feeds of the terrain via a retractable camera in the belly of the plane.

The video was sent back to a control station at Skopje where it was digitized and entered into the U.S. defense data dissemination system via the DISA provided point of presence access to the DISN. The DISN extended the digitized signal to the joint broadcast system's satellite broadcast injection site in CONUS. This is where the signal was converted to video and disseminated to the commanders involved in the operation anywhere in the world. The Hunter employed a parachute system that would deploy in the event of a malfunction that allowed it to float back to the ground to be recovered. Over hostile territories, the parachute deployment mechanism was disabled so that in the event of a shoot

down or malfunction the aircraft and its equipment would be destroyed upon impact with the ground. While I was in Kosovo, a Hunter UAV was lost due to a malfunction. Although the parachute deployed, the aircraft sustained heavy damage and could not be repaired.

There were problems with some of the surveillance and collection assets that supported ongoing ground operations. The Airborne warning and control systems (AWACS) aircraft flew out of Italian military airbases but after the air war these bases were placed on reduced operations at night and weekends and therefore, the aircraft could only be used during daylight hours and weekdays. This placed limitations on the operational flexibility needed by the ground commander. Additionally, with the resumption of civilian air traffic over the Balkans, AWACS stand off orbits had to be flown over the Adriatic making it difficult to sustain the line of sight communications with the MNB(E) TOC introducing other limitations to its usefulness to the commander. During civil disturbances, the commander needed live video feeds to the TOC. In particular, it would have been desirable to have an on the ground CNN-like live video feed but this was not possible with the capabilities deployed. Helicopter gun cameras and combat camera could videotape and photograph events but the tapes and pictures had to be taken back to the TOC for use by the commander and his staff. Platforms such as the UAVs and P-3s could provide live aerial video with a zoom capability but these too had some operational flexibility limitations.

The MNB(E) commander could task the U.S. Air Force Predator UAV, which was flown out of Tuzla, Bosnia, but he had to compete with SFOR and MND(N) priorities for its use. Needless to say, the commander MNB(E) priority was frequently not high on the list for the use of this limited availability, high demand asset. There were also weather differences between Kosovo and Bosnia that limited the operational flexibility of its use. There were times when the Predator could not be launched due to bad weather in Bosnia even though the weather in Kosovo was fine. The U.S. Army Hunter UAV was brought into the Kosovo operation specifically to help meet MNB(E) surveillance needs and to provide the commander some added operational flexibility to accommodate rapidly changing needs. Hunter was flown out of Skopje, Macedonia international airport. This had an unintended OPSEC consequence in that the Hunter takeoffs and landings had to be operationally coordinated with the Macedonian civil air traffic control. During the winter months, wing icing prevented both Predator and

Hunter from flying. P-3s equipped with video cameras replaced the UAVs during this period and the UAVs were sent back to their home bases for refurbishment and upgrades. Force protection concerns required the P-3s to be flown at higher altitudes than normal and this affected the quality of the video and usefulness to the ground component commander. Both the U.S. and Dutch P-3s were used. The initial use of the Dutch P-3 uncovered an interoperability problem caused by the use of different standards for video. The problem was resolved by simply using a commercially available U.S. and European standards compatible video display system. Neither the P-3 or helicopter gun cameras provided as good quality video as the UAVs systems.

A key source of intelligence in peace operations is human intelligence (HUMINT), and Kosovo was a HUMINT intense environment in which everyone became a collector. This placed a real challenge on the Task Force Falcon G2X who coordinated the task force's HUMINT activities and on the HUMINT Operations Cell (HOC), which integrated national and tactical level HUMINT. They were both required to deconflict collection activities, integrate disparate inputs from both traditional and non-traditional HUMINT collectors, and then analyze, archive and disseminate findings. There were situations where HUMINT, civil affairs, PSYOP, and the MSU were talking to the same person or persons that threatened their confidentiality and viability as a source. Death threats were made to people who were willingly seen working with KFOR soldiers, so in many cases these people refused to deal with KFOR or U.S. soldiers. Public approval of KFOR often varied widely between the Albanian and Serbian communities and depended on recent regional events. This required constant monitoring to detect changing situations, attitudes, and potential problems. The G2X chaired a weekly HUMINT coordination meeting with the commander, G2, G3, and all of the players conducting HUMINT related activities. The purpose was to have each element discuss its current and planned activities in order to deconflict efforts and seek commander guidance where necessary. Although invited, PSYOP did not always attend since they were very sensitive to being perceived as HUMINT collectors.

There were some concerns about several of the key U.S. CI/HUMINT leadership positions. The U.S. military felt that a CI/HUMINT officer familiar with USAREUR procedures should fill the G2X position and that the U.S. Defense HUMINT Service (DHS) should fill the HOC position. At the time I was in country, the DHS chief filled both

positions. There was also a U.S. Task Force CI Coordinating Activity (TFCICA) leadership position that was unfilled. Requests to USAREUR to provide U.S. Army CI/HUMINT officers to fill both the G2X and TFCICA positions were outstanding. There were other HUMINT operations concerns. The NATO ARRC had the Allied MI Battalion (AMIB) to support HUMINT collection needs at the outset of the KFOR operation but this capability went away when LANDCENT took over command of KFOR and was not replaced by subsequent commands such as EUROCORPS who led KFOR when I was there. There were non-U.S. collectors such as the MSU (Italians), British, Swedes, and Dutch who were very good at CI/HUMINT operations but these combined capabilities were not being fully exploited by MNB(E) or KFOR operations. In regard to the MSU unit assigned to MNB(E), there was an exchange of information but there were also coordination and collaboration conflicts in areas were their efforts and similar U.S. efforts were operating. Since Task Force Falcon intelligence operations were essentially U.S. only and the use of the MSU was unclear, they were not integrated into the intelligence operation as effectively as they might have been in a truly combined operation.

The military police criminal investigation division (MP-CID) recognized the need to collect information from non-traditional sources including the combat-arms units. They found at the outset that it was difficult to collect from these units but over time they were able to gain the level of cooperation needed. The MP-CID established a crime analysis cell that sorted through police reports and conducted some analysis of critical information. Over time, crime analysis cell assessments were provided to the ACE intelligence operations. Generally speaking, there was a need for the military intelligence activities to more effectively exploit non-military and non-traditional sources that supported the overall operation. These sources had insights and direct contacts with the local populace and leaders and organizations that were of interest to the military intelligence activities. The reluctance to exploit non-traditional sources appeared to be a military intelligence culture and trust issue that seemed to be driven by war fighting oriented doctrine and training that did not adequately address the needs of military support to peace operations.

As noted earlier, the relationship between CA/CIMIC and intelligence was highly sensitive, yet for peace support operations a relationship is necessary. There have been U.S. and NATO discussions about the role

of CA/CIMIC in support of intelligence operations but there was no doctrine on how they could or should support them. Certainly there were insights that they could provide through information they obtained about political-military situations, persons of interest, ethnic minority abuses, and rule of law and anticrime operations. Civil affairs was making progress in its effort to earn an appropriate role in support of the Task Force Falcon intelligence team. The civil affairs teams provided the G2/ACE information regarding NGOs, village assessments, key leaders, economics, and demographics. LTC Beard referred to his civil affairs team as information warriors. Over time they became more of a part of the intelligence team because of their on-the-ground insights.

PSYOP responses to task force priority intelligence requirements (PIR) and information requests (IR) were communicated through their daily situation reports, although they were a passive intelligence collector. Combat camera units were players on the intelligence team and were active participants in covering special situations and events in conjunction with PSYOP. They supported quick reaction forces (QRF) and deployed to support coverage of events such as the construction of a UCK monument in Kamenica and local manifestations celebrating the first anniversary of the liberation of Kosovo by the UCK and KFOR.

In the field, good cooperation was observed among Special Forces, civil affairs, PSYOP, and HUMINT teams as well as with other military units, such as the maneuver battalions and MPs. The MSU, although not fully exploited by the task force, provided useful inputs in their areas of expertise including organized crime, counterterrorism, corruption, and smuggling. Some open source information was shared with OSCE, which conducted open source monitoring of the media, but this was not a proactive two-way link between MNB(E) and OSCE. Some criminal intelligence was shared between the military and the UNMIK police but other military dealings with non-military organizations were much more cautious. There was a military need to verify by other means the information provided by them and there was a concern about how they would protect and use the information given to them. Sanitized security and safety information was provided to non-military organizations and the local population through meetings such as the regional and municipal joint security meetings chaired by the military with UNMIK, NGOs, and Serbian and Albanian participants. The civil affairs information centers located in the major towns of the MNB(E) sector were also used to provide information to the local

population. KFOR shared sensitive information with UNMIK at the COMKFOR and SRSG level and with some key staff elements such as UNMIK police. KFOR provided regional security and safety information to the humanitarian community information center that shared it openly with whoever needed it.

The task force OSINT capability was inadequately staffed and, like Bosnia, continued to be a challenge for the military. There were four translators (three Albanians and one Serbian) on Camp Bondsteel, but only one was a CAT II with a U.S. clearance. Camp Montieth had three translators (two Albanians and one Serbian). At Montieth they monitored Gnjilane radio and at Bondsteel they reviewed print material and tapes of radio broadcasts. *The Daily Falcon*, an open source newsletter, was produced from open source material and provided the task force a wealth of information. It was readily available in both soft and hard copy. The 66th MI produced the *Cloak and Dagger*, but this was a classified report and only accessible on the SIPRNET and focused mainly on Serbia. Access to the Foreign Broadcast Information Service was finally provided for the MNB(E) analysis and control element in June of 2000. The OSCE also produced daily reports and weekly summaries of its media monitoring activities and these were available in soft and hard copy as well. The OSCE monitored Albanian and Serbian print media, radio and TV and maintained an extensive database. However, the MNB(E) analysis and control element was not yet adequately connected with this source of open information collection and assessments. There were also over 50 Web sites that were searched daily by MNB(E) staff. Lack of resources limited cross-MNB and KFOR OSINT collaboration and sharing.

The modernization of intelligence collection and dissemination systems focused on building bigger pipes to get more information to lower levels more quickly. They had fallen short in providing more useful information to lower levels and this combination put the commander and his staff in the field in information overload. There was an expressed need for improved fusion and more analytical support to help get the information in a form that the commander could use to support his decisionmaking. In MNB(E), the stovepiped approach even extended to the daily intelligence briefings for the commander. When first attending the morning intelligence briefings, each organization element involved in some form of intelligence collection and assessment separately briefed its input for the day. As a result, the TFF commander

frequently became the integrator of information and in turn performed his own version of predictive analysis on the spot. He then generated courses of action and crafted intelligence requirements that drove near-term collection activities. Hence, subsequent daily intelligence briefings often became overly focused on answering previous questions of the commander. When LTC Greco, U.S. Army, arrived in June as the new Task Force Falcon G2, he made the ACE team chief responsible for the morning brief in order to provide one voice and overall assessment for the commander. However, since SOCCE reported directly to the commander organizationally, their briefing was separate from the ACE and sometimes there would be disagreements in assessments. These issues were not necessarily bad, but in some cases they could have been settled before briefing the commander. There were also some disconnects related to intelligence collection and mission planning that could have benefited from improved collaboration and coordination. The new G2/ACE approach was certainly far better than the earlier stovepiped briefings. Measures and processes were introduced to improve the fusing of information and to conduct predictive analysis to give the commander a big picture assessment and actionable intelligence for more coherent decisionmaking.

Adapting the task force's collection and analysis capabilities to meet their operational needs was a major challenge. The brigade intelligence operation was functioning as a division or higher level for intelligence operations, but not staffed or equipped to do so. Staff members generally were not senior intelligence officers with division level experience and did not possess the broad set of analytical skills, linguistic skills, or specialized knowledge to do the complete range of soft analysis needed. Furthermore, the military-oriented collection processes and capabilities had to be adapted to meet the asymmetrical threat challenges of ethnic violence, terrorism, and organized crime. They had to conduct surveillance in urban areas and exploit unconventional communications such as commercial radios, cellular phones and ham radios. Exceptions to force protection policies were necessary to facilitate field HUMINT team (FHT) collection activities. FHTs could consume local beverages and food and visit shops, cafés, and business establishments. They could also remove flack vests and Kevlar helmets during meetings with locals. SOCCE personnel were exempt from the force protection polices and wore BDUs without name and rank patches while walking around the towns and villages and some lived in safe houses in the communities where they were operating. Non-traditional databases such as

KRYPTON and archives had to be created to address needs such as individual profiles, ethnicity profiles, criminal activities, organization profiles, detainee profiles, and documentation of acts of ethnic violence. The limitations of performing soft analysis meant it was easier to analyze what happened rather than predict what might happen. LTC Greco was able to make some improvements in the task force focus on predictive analysis and introduced some strategic and big picture thinking and analysis.

Information sharing was not a natural proclivity for many of the multinational military and civil organizations and actors involved in the Kosovo operation. Military intelligence organizations were not accustomed to sharing with international and NGO organizations and vice versa. There were suspicions of intent on both sides. NGOs were concerned about maintaining impartiality and tended to keep the military at arm's length. For operational security reasons, there was reluctance on the part of the military to share time-sensitive operational information with anyone, especially multinational political bodies such as the U.N. and NATO headquarters. This was most visible during the air war where SHAPE was reluctant to share information with NATO headquarters and others outside of the direct military chain of command. Information coordination centers had to be established to facilitate sharing with groups such as NATO. In Kosovo, KFOR and the MNBs created information centers to facilitate information sharing with NGOs and international organizations.

For military to military sharing, strict need-to-know rules were applied. Fears that data would be misused or that databases might contain inaccuracies prevented more open exchanges. Not all nations in the military coalition were treated as equals and many partners in the Kosovo operation were former enemies in the Cold War, so differing restrictions were placed on sharing sensitive information with them as well. There was a need for the Western nations to learn how to make better use of the military intelligence and cultural insights that these former enemies brought to the table in support of the coalition peace operation. There were also other non-NATO troop committing nations that had capabilities KFOR and the MNBs could have used more effectively.

No matter how dedicated each nation was to the overall cause, there was a tendency to protect intelligence capabilities, to control what tasks they performed and to control sharing and dissemination of their

products. Needless to say, intelligence sharing in a combined operation continued to be a major challenge. There were a number of obstacles that impacted KFOR and MNB operations, such as a lack of accurate, consistent and timely intelligence, redundancy and wasted efforts, and a lack of experienced and trained KFOR CJ2 intelligence staff. There were also problems related to cooperation, coordination, collaboration, and sharing to leverage and exploit all of the multinational capabilities employed in support of KFOR and the MNBs. For example, there was little obvious KFOR and cross-MNB collaboration to exploit the combined capabilities of the U.S., Norway, Sweden, and British EW strengths and the U.S., MSU (Italians), British, Swedish, and Dutch CI/HUMINT capabilities. MNB(E) was able to achieve some signals intelligence collection collaboration among the U.S., UK, French, Norwegians and Swedes. The U.S., British, French, and German UAV capabilities were not shared nor were they leveraged in combined operations or to fill gaps in operational needs. Some UAV videos and pictures were shared, but not in real time or as a combined operation.

NATO policy directs member nations to provide intelligence to NATO as a national requirement and NATO assembles, classifies, and disseminates the processed intelligence to authorized users. An unintended consequence of this policy as it applied to the KFOR operation was that NATO not only required the participating member nations to provide the intelligence but they also required them to provide the communications to deliver it to KFOR headquarters as well. In this case, the nations provided intelligence through the national intelligence cells (NIC) collocated with KFOR headquarters and through the MNB lead nation provided intelligence operations. In both cases, there were no NATO communications requirements for intelligence connectivity to support these operations. Under the ground rules, they were considered national activities. Since NATO policy does not allow use of its communication systems to support national requirements, the nations had to provide their own intelligence communications connectivity to deliver intelligence to KFOR.

There were several key players involved in the KFOR and MNB combined intelligence operation:

- First, there was the international, fully integrated combined headquarters intelligence staff of the KFOR CJ2 organization element. The CJ2 organization was not, however, modeled after

an existing headquarters staff so it did not have a national design and established procedures. The organization and procedures used were developed for the KFOR operation. The staff was contributed by nations in accordance with internationally allocated billets and therefore, was not a trained and experienced intelligence operation. The senior intelligence officer (CJ2) was a U.S. military officer. The staffs filling the KFOR CJ2 deputies and subordinate positions were well representative of the NATO allied nations. The senior U.S. presence assured support from the extensive U.S. intelligence capabilities. The intelligence staff assumed an allied flavor and generally did not reflect national views, but did reflect the needs of the combined forces commander.

- Second, a number of National Intelligence Cells (NICs) were established and collocated at KFOR headquarters to contribute national intelligence to the KFOR commander through his CJ2 and intelligence staff. The major contributing nations were the U.S., UK, Belgium, France, Germany, and Italy. The U.S. NIC provided intelligence support to KFOR mainly through briefings to the KFOR CJ2 and the U.S. Deputy Commander KFOR, both of whom were special access cleared U.S. military officers. Weekly NIC meetings were held among the key players, but the reality was that many of the NICs absorbed more information for their home audience than they contributed to the KFOR operation.
- Third, the U.S. NIC at KFOR was a combination of a Theater Intelligence Support Team that was essentially a field extension of the EUCOM J2 and the Joint Analysis Center at Molesworth, England and a small National Intelligence Support Team (NIST). The U.S. national intelligence agencies were represented through the NIST. The NIST had access to the direct feed of raw collection from U.S. national level sources that provided information releasable at the KFOR combined operations level for selected categories (e.g., imagery, SIGINT and OSINT material). There was a slight problem in that the U.S. national level agencies tended to write their reports at the highest U.S. classification level and then upon request would decompartment to coalition releasable. Think and do combined operations is an intelligence culture change yet to be realized. A role the NIST

served as a direct link for rapid and responsive decompartmenting of U.S. high-level intelligence for release to KFOR CJ2 and selected allies.

- Forth, the intelligence staffs (G2) of the five multinational brigades, who were the principal subordinates of the combined forces commander under the combined headquarters, provided KFOR releasable intelligence to the KFOR CJ2 through daily intelligence summaries and other inputs as deemed appropriate. These staffs generally wore national hats and therefore, were at times reluctant to share certain intelligence not only with their coalition force superiors but also with officers from their own nation who were occupying higher level positions in the coalition structure. One needed to be reminded every now and then that the intelligence operations were nationally driven and controlled not KFOR driven, as a true combined operation would be conducted.

The KFOR dissemination capability supporting intelligence sharing consisted mainly of three independent secure information networks and the NATO provided STU-III B secure voice capability that used the KFOR common user voice switched network referred to as the KPN. The KFOR information networks consisted of: the CRONOS network, a NATO Secret level operations and intelligence information system that provided access to NATO intelligence applications and databases; the LOCE network, a NATO Secret level intelligence dissemination system that provided access to imagery and other intelligence stored on a releasable to NATO server at the U.S. Joint Analysis Center in Molesworth, England; and the KFOR Secret Network (KSN), a KFOR releasable information system that allowed access to NATO member military elements and some of the non-NATO member military elements supporting the KFOR operation. Therefore, at best the de facto KFOR intelligence system architecture was a federated network of stovepiped NATO and national systems that for NATO and national security policy reasons were not interconnected. Hence, exchange of information was essentially by hard copy and “sneaker net” soft copy. NATO had no direct access to the national intelligence systems other than through persons with access to special information sharing arrangements with the KFOR NICs and access to nationals manning the NATO provided CRONOS and LOCE network workstations that were located in the MNB operations and intelligence centers.

Special classifications and storage and release procedures had to be established by NATO for use by the coalition forces. In the theater of operation, there were multiple classifications: national releasable intelligence, RELNATO for members of the NATO alliance, and RELKFOR for certain contributing nations. There were differences in NATO and national doctrine and disclosure rules and not all nations of the coalition were treated equally. For the U.S., there were strategic and operational level foreign disclosure restrictions that limited the tactical level's ability to share certain information with selected nations. Even within these levels there were different bilateral arrangements for sharing among authorized nations. There were even more strict release procedures for international organizations such as UNMIK and UNMIK police, the non-NATO troop committing nations assigned to KFOR, and the NGOs that resulted in limited sharing of information with many of them.

National differences also adversely influenced sharing. The British and French tended to be very need to know oriented and kept others at arm's length. The U.S., as the dominant player in reconnaissance, surveillance, and intelligence, was viewed as being even more insular and to some extent, even arrogant. The U.S. feeling that they had a better view of situation awareness than anyone else did not foster in MNB(E) a need to proactively share with KFOR CJ2 and other MNB G2s, especially since they received less information than they provided. Additionally, the U.S. NIC at KFOR had access to the same national and theater level information that was available at MNB(E). A difference was that they did not have an analysis and control element to exploit intelligence onsite. However, the U.S. NIC/NIST at KFOR did have the ability to release sensitive intelligence that essentially gave the KFOR CJ2 and some allies access to most things that the MNB(E) G2/ACE had. There was also the feeling that KFOR CJ2 really had little more to offer than some occasional details from other sectors. In spite of a seemingly unwillingness on the part of the U.S. to more openly share, MNB(E) did share selected U.S. source intelligence with the KFOR CJ2 and the other MNB G2s. The MNB(E) G2/ACE on occasion provided SIGINT, EW, and CI/HUMINT summaries and imagery. They also shared operations specific information bilaterally with the British, Germans, and Italians.

The daily KFOR INTSUM was essentially a summary of intelligence provided by the NICs and the MNB G2s. There was some added input

from the CJ2 staff sources and analysis related to KFOR special interest areas. The daily INTSUMs produced and disseminated by KFOR and the MNBs was the primary source of shared intelligence. Otherwise, there appeared to be little other active sharing among the MNB G2s. The lack of more extensive intelligence sharing may be simply due to the fact that the five nationally-led sectors were essentially set up as independent operations except for cross-boundary operations where there was a select need to share. On the other hand, the absence of an operations and systems architectures for KFOR intelligence may have been more of a contributor and was the likely reason for the intelligence disconnects and unnecessary duplication of effort across KFOR and the MNBs.

The U.S. communications security policy does not permit NATO classified information to be sent directly over U.S. secure communications systems. Additionally, most of the U.S. special security facilities used by intelligence personnel do not have direct access to the NATO dissemination systems. Thus, there were problems in getting time sensitive NATO classified information to U.S. intelligence analysts in these facilities, especially those located in the United States. The U.S. intelligence producers also persisted in using U.S.-only classification and secure information systems to disseminate intelligence releasable to NATO. During the air war over Serbia, this problem was exacerbated to the point that U.S. personnel had to print out NATO releasable material from the U.S. system, digitally scan the paper product, reclassify it for release to NATO and insert the product into the NATO dissemination system.

In the KFOR operation, there were other factors that worked against U.S. intelligence personnel using the NATO systems, most notably were lack of familiarity and accessibility. MNB(E) intelligence was essentially a U.S.-only driven operation and the personnel were trained on and accustom to using U.S. systems to conduct operations. The NATO systems were new to them and they were not that familiar with the capabilities offered and hence, reluctant to use them. As a result, the NATO systems were essentially used for secure e-mail and to exchange the daily INTSUMs with KFOR and the other MNBs. There was a LOCE terminal in the TFF ACE but maintenance and crypto problems resulted in the staff not relying on its use. Besides, the U.S. systems available to the ACE personnel not only offered access to

similar information but access to more extensive intelligence databases and analyses.

NATO provided the MNB(E) headquarters with KPN voice network access and STU-IIBs for secure voice and secure information network access and two CRONOS workstations and a KSN workstation. One CRONOS workstation was located in the TFF ACE and the other in the G4 area of the TOC. The KSN workstation was located in the G3 plans area and many of the staff did not know that it existed or what it was used for. This was true of the KPN access as well. It was referred to as the white phone that rang every now and then but no one was sure what it was to be used for. Three workstations were not enough to provide the operational access necessary for more extensive use of the NATO capabilities by the intelligence and operations staff. They were physically located in different areas of the TOC and not where the duty staff would normally be working further limiting their operational utility. The workstations located in the ACE introduced an additional restriction in that the ACE was a special security facility with access limited to appropriately cleared personnel so this significantly reduced the availability of workstation access to a broader set of likely users such as civil affairs and PSYOP staff. Another factor influencing the lack of use of the NATO provided capabilities was the MNB(E) operations and intelligence staffs were physically separated in different buildings within the TOC compound. If there had been an integrated MNB(E) combined ops-intel cell, then the CRONOS, LOCE, KSN, and KPN terminals could have been physically collocated enhancing their utility to the overall operation. The fact that the NATO capability was not extended to the tactical units also limited its accessibility and usefulness to battalion ops-intel staff.

The U.S. procedures for sharing with NATO and non-NATO nations were cumbersome as well. Downgrading the classification of U.S. national products before they could be shared was problematic. Analysis Control Teams (ACTs) composed of several military intelligence analysts with appropriate language skills were used by MNB(E) and placed with multinational partners assigned to MNB(E) to facilitate intelligence sharing with them. Maneuver and tenant units, such as civil affairs and MPs, also used ACTs for intelligence support and as a liaison to the Task Force Falcon analysis and control element. Although ACTs helped, it was not a totally satisfactory solution. The Task Force Falcon G2 and KFOR CJ2 were both U.S. Army officers and

had a good personal working relationship, which facilitated intelligence sharing between KFOR and MNB(E). Since the U.S. NIC and its national intelligence support team at KFOR were authorized to release U.S. information to KFOR, they became a useful vehicle for getting certain sensitive U.S. information released to KFOR CJ2 and certain allies.

Intelligence sharing within U.S. elements of Task Force Falcon was a challenge as well. Information sharing and coordination disconnects existed between almost every level. The G2X had problems deconflicting the HUMINT collection efforts. There were a number of initiatives aimed at improving intelligence sharing and bridging disconnects. Weekly G2/ACE SCI-level video teleconferences were held with USAREUR and the JAC. The NIST held weekly video teleconferences with the Balkans Task Force. Brigade G2 and battalion S2 conferences were held twice a month. The S2s visited the ACE and the TFF G2 visited different battalions each week. ACE personnel were sent into the field for several days at a time to get a firsthand understanding of the environment and needs at the lower levels. SIPRNET connectivity was extended to battalions and this gave them direct access to various databases and intelligence Web sites. Databases were also put on CDs and sent to lower levels, such as battalion command posts. The ACTs had SIPRNET access and these teams, where necessary, translated the releasable intelligence from SIPRNET sources into the language of the nation being supported. This was particularly true for the Russians who had few English-speaking officers. The U.S. team located with the Russians not only translated releasable intelligence into Russian, but news stories from the Internet that related to Chechnya were translated as well. The Russian units in Kosovo were from the Chechnya operation and many would be returning to that operation at the completion of their Kosovo tour.

Translators and Interpreters

The U.S. military did not have enough Albanian and Serbian translators to fill the needs of their elements interacting with the local Albanian and Serbian population. There was a need for translators with military clearances and accesses. CAT-II and CAT-III linguists were required for sensitive and classified missions such as those conducted by SOCCE, HUMINT teams, SIGINT collectors, and other special intelligence operations. The CAT-II and CAT-III interpreters required

additional qualifications such as written language proficiencies. If they were used for interrogations then they needed to be emotionally suited to work in that environment. For electronic warfare operations, they needed to be able to translate and comprehend the discussion quickly without time to review recordings or notes. They also needed to be willing to work long hours under field conditions for multiple days. The CAT-II and CAT-III linguists were in short supply and were stretched between the Kosovo and Bosnia operations. Fluent bilingual interpreters were also hard to find. Most American interpreters did not speak both Albanian and Serbian. Because of the short supply of good interpreters, there was a tendency for U.S. elements to get attached to a particular translator and resist release for their use elsewhere.

It was necessary to contract linguist support. TRW was the contractor who provided interpreters from a pool of U.S. contracted and local hires. Many of the local linguists had little or no background in the military and initially had difficulties translating military jargon. Because of the deep-rooted ethnic hatred, there were problems with Albanians translating in Serbian areas and vice versa. The fact that most Albanians could speak Serbian did not necessarily make them suitable for interaction with the Serbian communities. Interpreters are cultural liaison agents. Besides the language, a lack of trust and ethnic tension were key factors. Even American born translators exhibited biases. Both ethnic groups could tell the ethnicity difference immediately and this could provoke heated reactions such as cursing and spitting at the interpreter. Many times the Albanian interpreters would say they were from Macedonia. Names, however, were revealing since they could identify the area or town or clan from which the individual came from. It was also necessary to be aware that sometimes interpreters would interpret and not translate. At times they would put their own spin or political slant on the translation. Many others were not fluent in the language they were translating and could not interpret properly. On one particular civil affairs visit to Kamenica, it became clear that the Albanian interpreter was having trouble translating into Serbian, so the civil affairs officer stopped the meeting and told the church leaders that they would come back at another time.

Elements such as civil affairs had to mainly rely on local hire (CAT-I) interpreters to support their missions. The CAT-I interpreter contracts strictly required them to only be able to provide interpreter support and not offer social, religious or cultural insights to the teams. However,

without the institutional knowledge of Kosovo, teams often solicited such information and many of the interpreters welcomed the opportunity to educate and explain the many cultural and social aspects of their society. Nevertheless, it had to be remembered that the local interpreter's first loyalty was to his or her country, not the United States. Since the United States forces needed interpreters to support them, those hires that were detrimental to the missions would have normally been replaced. However, that did not frequently happen because interpreters were in such short supply.

Force Protection and OPSEC

After a year of military presence, the operational environment was reasonably stable. There were fewer incidents of attacks against KFOR soldiers and facilities. Soldiers came into more frequent contact with locals as patrols of towns and villages increased and civil affairs and PSYOP teams actively engaged local businesses, civil government organizations, and the local population in general. More locals were out and about on the streets and attending the weekly markets. There were concerns by some that the reduced level of violence might lead to complacency and a relaxation in the security posture of the military but the commander MNB(E) continued to be concerned about the high target value and threat to American soldiers. Thus, strict force protection rules remained in effect for movements off base in the MNB(E) sector. Travel off base required two-vehicle convoys, two-shooters per vehicle, flack vests, Kevlar helmets, and locked and loaded weapons. Soldiers were not generally allowed to consume local food or beverages or purchase things from local shops, cafes, and business establishments. It was felt by many in the field that the flack vests, helmets, and weapons intimidated local civilians and was awkward and disruptive in small offices and other areas where the teams came in contact with the locals. Some relaxation of the rules were being enacted for forces such as field HUMINT, civil affairs, and PSYOP teams who dealt with the local people everyday. One was constantly reminded, however, that in Kosovo the situation could and did change at a moment's notice. As a result, force protection, as well as OPSEC, continued to be a challenge that needed to be assessed and managed carefully by the military.

Although force protection was not a mission it has become one, as the U.S. military has become overly risk adverse for peace support operations. The reason for this seemed to be largely political and driven by the view that such operations can and should be bloodless. This was certainly the view of our allies (especially the British) regarding U.S. force protection measures. Some U.S. field commanders expressed concern that if the U.S. continued to pursue this philosophy, we might breed a generation of military leaders that may not make the tough decisions when it comes to putting soldiers in harm's way. A number of commanders also expressed the belief that approval authority for many activities was being retained at too high a command level. For example, assessing and managing risk to his forces is a fundamental task of any combat commander. The task force conducted a continuous and extensive intelligence and risk analysis to anticipate problems before they occurred and to take reasonable precautions in allocating forces and tasks in order to minimize the risk to the soldiers while still executing the mission. It was important that the soldiers were seen as a force that was professional, impartial and highly capable so that it gained the trust and confidence of the population it was there to protect.

Unsecured communications became an OPSEC problem with the pervasive use of commercially purchased handheld radios such as the Motorola *TalkAbout* sports radios. They were used for convoy communications, for dismounted operations and as on base communications. Military tactical radios also had to be operated in the clear mode in order to overcome an interoperability problem that precluded secure communications with non-U.S. forces in the MNB(E) sector. This was the case for cross-MNB border communications for operations such as joint patrols as well. There were also cases where MNB(E) soldiers were in tactical pursuit of civilian vehicles about to cross the border had to notify check points on the other side using non-secure communications. There were still numerous international and local radio, TV, and print journalist questioning soldiers in the field. The Serbian press showed up at demonstrations in Serbian communities, filmed the activities and interviewed locals. In one incident I witnessed in Strpce, they interviewed one of the KFOR interpreters. Incidents of photographing U.S. facilities and soldiers were on the rise. A large number of local hires worked on Camp Bondsteel and Camp Montieth and also populated the interpreter force and their activities needed to be closely monitored, including security screening before being hired by the contractors Brown and Root and TRW.

The forces in the field had to constantly be aware of the complexity of the environment. Serbs were reluctant to talk. Albanians were more willing, but often lied. The Albanians wanted conflict to exist between KFOR and the Serbs, while the Serbs seemed to want the chaos to continue. Both ethnic groups were known to be good at human intelligence, propaganda and intercepting communications traffic. Radios tuned to KFOR frequencies and weapons were found during cordon and search operations. The weapons usually found were the basic Kosovo home defense package that consisted of an AK-47, 300 rounds of ammo and a hand grenade but some times large caches of weapons were found as well. It was known that Albanian and Serbian intelligence services and organized crime contacted the local Albanians and Serbs hired by KFOR so monitoring these activities was a major challenge for the counter intelligence teams. Propaganda was being published in local newspapers and broadcast on local Kosovo radio stations. Since there were no Serbian newspaper publishers in Kosovo, Serbian language newspapers came from Serbia and as expected, contained propaganda as well. An aerial photograph of Camp Bondsteel even showed up in a Serbian newspaper. The OSCE monitored the media for abuses and UNMIK had policies in place against misuse of the media and took actions to shut down newspapers and radio stations that violated its policies.

The variety of Albanian and Serbian activities employed against KFOR and its mission presented MNB(E) with continuous force protection, intelligence and counter intelligence challenges. The Joint Staff Integrated Vulnerability Assessment team was used to help baseline the force protection posture of MNB(E), identify weaknesses and develop recommendations for improvements. MNB(E) established a force protection working group to manage the resolution of outstanding deficiencies. There were other physical security, COMSEC, INFOSEC, and OPSEC analysis done to assess vulnerabilities and develop initiatives to improve the security posture of the task force and raise the awareness of the importance of using proper security procedures. Force protection and OPSEC were a common theme of the commander at the daily battle update briefings.

Special Operations Forces Liaison Elements

While on a visit with the Vitina civil affairs tactical support team, I had the opportunity to meet with two of the Special Forces liaison team

members and their interpreter, who was a CAT-II interpreter from New York City. We met at Sam's Pizzeria on the main street in Vitina across from the UNMIK police headquarters. Ironically, Sam's did not serve pizza and was well known to be a front for organized crime. The café was undergoing construction to include a very nice restaurant area. The commercial power was off, a regular occurrence in Kosovo, when we sat down to have a cappuccino. There were a number of suspicious locals sitting near us trying to listen to what we were saying. While sitting in the café having a discussion, a truck pulled up and delivered a portable power generator. Shortly thereafter we were served a freshly made cappuccino.

The purpose of the get together was to learn a little more about the things SOF elements do in support of peace operations. The teams lived in a safe house (with appropriate force protection) in town and spent a lot of time walking around town talking to business people, town leaders and the general public. They did not come under the TFF force protection rules, so they wore BDUs with no name, rank or other identity patches and drove Pedjero SUVs. As they put it, "if you want to know what's going on then you need to get downtown and talk to the people." SOF's purpose was to observe, meet, and develop contacts and trust relationships in order to build a better understanding about what was happening in the area. They spent time in cafés and ate in local restaurants talking with various individuals. Locals would visit the safe house to have discussions as well. It was noted that when KFOR first arrived in country, many of the stories about atrocities were probably true. Today, the stories tended to be embellished and the real truth is less obvious.

The team members I spoke with were from Ft. Carson, Colorado, and were on a 5-month assignment. They felt that peace operations did impact combat skills and that it took time to re-train after serving in such an activity. The frequent rotations were a problem for maintaining trust relationships with locals on the ground, but they tried to have overlap in team members to facilitate the transition. Knowledge of local customs, conversation skills, type-A personality, and good listening skills were important attributes for team members. They did cross-level briefings for teams rotating in and out, and the after-action reviews were built into pre-mission training. SOF members with in-country experience discussed their lessons with those preparing to deploy. They were trained on what to eat and not eat. They told me that their

unit had a high rate of tuberculosis due to the many different areas they deploy, and the fact that they live, eat, and drink on the economy. They cautioned me to stay away from dairy products, including cheese that the locals tend to put on everything, for fear of contracting hepatitis.

Kosovo was essentially made up of small clans of either Albanians or Serbs, but in some rare areas there was a mixture. If something happened, they would not give information on each other. As a result, it was very hard to break into the clan culture. During the cold weather there were not many problems because no one went out. However, with warm weather, problems started to occur. The greatest challenge faced by SOF teams was the ability to present an open presence to the clan-based population so they would open up and talk about what was going on. The teams found it difficult to know who to really trust or believe of the locals.

The daily reports from the field teams went directly to SOCCE at Task Force Falcon and not through the intelligence chain of command. SOCCE was the first to brief at the daily intelligence briefing for the commander. It was clear BG Sanchez placed a lot of trust and confidence in their reports. The Special Forces team tried to match its younger soldiers with the young locals and the mature soldiers worked with the older folks.

There were shifting local perceptions and expectations with the passing of time. KFOR was viewed at the outset as the liberator. Then the Albanians began to retaliate against the Serbs and the level of violence increased. The sympathy of the international community was initially with the Albanians, but with the escalation of violence against the Serbs this sympathy was shifting to the Serbs. Albanians were concerned about the loss of international support.

Combat Camera

The mission of combat camera was to install, operate, and maintain tactical visual information systems, and to provide division level commander's situational awareness and decisionmaking support through visual documentation of the operation. They provide:

- Documentation to support the onsite commander, essential for command and control, as a battlefield information resource, and force multiplier;
- Support to the requesting staff sections for reconnaissance, intelligence and operational missions to support their programs; and
- Documentation of operational forces as a permanent visual record to the joint combat camera center (Pentagon). Combat camera records of DoD activities allow offsite management authorities to visualize ongoing activities.

Combat camera consists of soldiers with still photograph and videography skills. They are employed for the purpose of acquiring tactical visual documentation of the actions of U.S., allied, and hostile armed forces in combat and combat support operations, and in related peacetime training activities such as exercises, war games, and operations.

Combat camera provides near real time tactical and visual information to keep the command informed on the conditions and actions in the area of operations. The imagery is used to assist commanders at all levels to make informed decisions about effective use of combat and combat service and support assets. At times the teams find themselves being viewed by the military commanders as something between media and military. However, once they have had a chance to work with the commanders, they were more likely to be accepted.

The combat camera team reported to the MNB(E) G3 and was led by 1LT Tony Vitello, 55th Signal Company, U.S. Army. The team was located on Camp Bondsteel and had an office and small production facility in the tactical operations center. There were three two-person teams, consisting of a photographer and a videographer, which went into sector on missions. The team's Humvee did not have a radio but it was equipped with a Qualcomm *Omnitrac*s that could be used for tracking their location. Because force protection rules required two vehicle convoys when going into sector, the team had to link up with a unit that was going outside of the wire. Sometimes the teams had to be creative to find a link up, such as the time I traveled with them to support a MEDCAP out of Camp Montieth. In this case, we had to linkup with the early morning military escorted bus service from Camp Bondsteel to Camp Montieth. At Camp Montieth we linked up with the MEDCAP team and also with the evening bus

returning from Camp Montieth to Camp Bondsteel. Other times the linkups were more straightforward, such as the time I accompanied them on a PSYOP support mission when we linked up with the PSYOP team at Camp Bondsteel.



Figure 1. Combat Camera in Action

The teams have conventional and digital still image cameras, as well as digital video cameras (Figure 1). Upon return from a mission, digital pictures were reviewed and the best ones were selected, annotated, and e-mailed to the joint combat camera center for posting on the Web site. The team also had a limited photo and negative scanning capability and still and video editing capability. Digital stills could be put on CDs, ZIPs and JAZZ disks, e-mailed, or made into hard copies. There was also a limited night vision still and video photography capability. Tasking was either direct from the G3, by FRAGO or word of mouth. They offered a 24-hour turnaround for products.

Combat camera covered quick reaction forces and significant operational events to document for historical purposes, use by the intelligence cell, and for after action reviews. They documented training and MMB(E) TOA activities and events, such as the riots in Metrovica and Gornje Kuse, cordon and search activities, MASH surgical operations, MEDCAPs/DENCAPs, site evaluations, aerial photos of villages, and nighttime operations. Combat camera supported special documentation needs for civil affairs, PSYOP, and information

operations. For example, when I accompanied combat camera on a MEDCAP mission, they were photographing various scenes for possible use by PSYOP for handbills or posters as part of the MNB(E) information campaign to promote the good things KFOR does for the community. Combat camera did not do command photos or group photos or lend their equipment to others.

Staff Weather Operations

A visit was made to the 7th Expeditionary Weather Squadron (EWS), commanded by Major Clements, U.S. Air Force. Staff weather operations (SWO) had a team of 4 forecasters and 3 observers who provided weather forecasting services for the task force and supported over 40 aircraft in 5 unique weapons systems in 7 separate flying units. They also had one forecaster at Camp Able Sentry who supported CH-47s and UH-60 MEDEVACs. The Air Force served a 90-day tour, whereas the Army tour was 6 months. The SWO expressed some concern about the number of unaccompanied tours the weather staff was being assigned. Normal assignments are accompanied, but for longer operations and the change in mode of the operation have raised concerns about the ability to retain forecasters and to attract new recruits into this career field.

Staff weather operations was a critical ops-intelligence player that provided accurate, timely, and relevant weather intelligence for planning, weather warning, and operations. The 7th EWS mission was:

- Support Task Force Falcon headquarters staff;
- Resource protection through weather advisories, watches, and warnings;
- Flight weather briefings for Task Force Falcon and transient aircraft; and
- Weather observations from U.S. base camps within MNB(E).

The area between Skopje, Macedonia, and Camp Bondsteel was mountainous and forecasting weather along the air route was difficult. Frequently helicopter pilots would unexpectedly encounter bad weather. An automated system was being installed to improve their ability to meet mission needs and to accommodate future staff reductions. The new

system also offered online weather service via dial-up access through DSN. Weather was of interest to everyone on base and was the first morning and evening briefing for the battle update brief. In addition, the SWO supported the analysis and control element, daily forecasts, FRAGO weather (weekly), aviation briefings, 3-day forecasts for *The Daily Falcon*, operational mission briefings (QRFs), JVB weather briefings, 24-hour observations and forecasts, and UAV support.

The tactical meteorological (TACMET) and communications systems supporting the Camp Bondsteel weather operations included systems such as the portable automated surface observing system (PASOS), the remote miniature weather station (RMWS), the NATO automated meteorological information system (NAMIS), Ellason Tactical Weather Radar, tactical wind measuring set TNQ-36, Wrasse near real-time satellite-gathered weather receiver, pilot to meteorological service voice system (PMSV), BF Goodrich lightening protection system, light weight satellite terminals, TV-SAT, NIPRNET and SIPRNET access, MSE phones and FM, UHF, and SINCGARS radios.

The SWO weather operations had a number of other challenges as well. There was a need to identify other meteorologist in Kosovo and to better coordinate information sharing among the related weather activities. There was a need for improved weather forecasting during degraded winter operations. The SWO needed access to Kosovo area weather history, case studies and observation databases and there was a need for additional portable automated surface observations sensors in U.S. zone and other KFOR locations.

CHAPTER XXI

Civil-Military Operations

Larry Wentz

The U.S. military civil affairs (CA) doctrine uses civil-military operations (CMO) as a comprehensive term that describes the general activities that a military force conducts in coordination with and in support of civilian entities in a peace operation. The U.N. and NATO refer to these activities as CIMIC (civil-military cooperation). The U.N. uses the term *civil affairs* for its civil administration activities. In this chapter, CA and CIMIC are used as they apply to CMO activities conducted by the U.S. and NATO elements respectively.

KFOR headquarters conducted operational-level CMO that focused on promoting unity of effort through coordination and synchronization of the tactical-level CMO conducted by the Multinational Brigades (MNB). The MNBs focused on the traditional activities that promoted the legitimacy of the military's presence and supported the civilian-led peace building efforts. Although the military force, KFOR, was not under the executive authority of the Senior Representative of the U.N. Secretary General in Kosovo, the NATO OPLAN 31402 made it clear that KFOR's mission was to coordinate with and support UNMIK. Commander KFOR General Directive 1 recognized that "the success of KFOR was inextricably linked to the success of UNMIK." Thus, the mission of CIMIC and CA was to conduct civil-military operations in support of KFOR and its MNB efforts to establish a safe and secure environment. The mission was also to provide within means and capabilities support to the U.N. by facilitating the execution of the UNMIK four pillars: humanitarian assistance, civil administration, institution building, and economic reconstruction. Support to international organizations (IO) and non-governmental organizations (NGO) humanitarian, public safety, and infrastructure repair activities was permitted as well, as long as it was conducted within military means and capabilities.

During the time of my visit to Kosovo, support elements from the U.S. Army Reserve 411th and 443rd CA battalions were combined to form Task Force Yankee to conduct the MNB(E)/Task Force Falcon CMO activities. Task Force Yankee was under tactical control (TACON) of Task Force Falcon (TFF), and under operational control (OPCON) of Special Operations Command Europe (SOCEUR). The commander was LTC William G. Beard, U.S. Army Reserves, who was also dual hatted as the MNB(E)/Task Force Falcon G5. One of his duties as the G5 was to represent MNB(E) when dealing with KFOR, UNMIK, and civil and government organizations. A change to this arrangement occurred with the June 2000 transfer of authority to the 1st Armored Division. A deputy commander for civil-military operations was created under the new MNB(E)/TFF commander, which raised the level importance of the effort and placed a more senior officer in position to negotiate on the behalf of MNB(E). TF Yankee soldiers staffed both the G5 section and the CA tactical support teams (TSTs). The G5 operation was located in the MNB(E) tactical operations center on Camp Bondsteel and the TSTs were located in SEAhuts dedicated for CA use on Camps Bondsteel and Montieth.

The G5 staff not only served as MNB(E)/TFF plans and policy, but was the operations element of the civil affairs battalion as well. The G5 team consisted of five officers and two sergeants. The team was not a trained G5 staff element. The CA battalion commander had to split his time between commanding tactical civil military operations and performing the duties of the G5 and this challenged his ability to effectively cope with the demands for his active involvement in both functions. The ad hoc G5 staff struggled to meet the operational level plans, policy, and program demands, while at the same time focus on CA tactical operations and command issues. The operational demands suggested there was a need for both a trained G5 staff with a dedicated leader and a dedicated civil affairs tactical commander.

The G5 staff monitored and managed the \$5 million DoD Humanitarian Assistance (HA) program and conducted analysis and assessments of HA projects based on the Task Force Falcon commander's priorities. They were also often involved in the coordination and some times participated in the tactical distribution of humanitarian supplies in the MNB(E) sector. There was a HA board that was used to review and approve projects for funding and implementation. The board required detailed presentations based on a fully integrated staff assessment

that included the engineers, legal, and other staff sections as appropriate. Detailed explanations with engineer sketches and other supporting material were required as well. It was felt the HA project approval process was slow and cumbersome. The G5 produced a staff study recommending procedures for quick impact humanitarian projects with funding of \$2,500 or less. The study recommended the use of blank purchasing agreements to accelerate the processing and approval of funding for small projects.

As the lead planner for MNB(E), the G5 supported the Joint Registration Task Force. During civil registration, they maintained communications with the civil affairs liaison officer to OSCE, as well as maintained statistics on the number of registrants and registration site openings or closings in the MNB(E) sector. The group briefed these statistics daily at the evening battle update brief. G5 was also responsible for planning for the return of Serbian internally displaced persons (IDP) and Albanian displaced persons (DP). They used reports provided by the Joint Committee for Returns to support the planning.

The G5 staff maintained a database containing information on NGOs, village assessments, key leaders, local economics, USAID programs, area demographics, village locations, daily CMO situation reports, and other related information. The G5 staff responded to information requests from the G2/ACE, tactical support teams, other TFF units, and higher headquarters such as KFOR and USAREUR. Sometimes the information requested was not available from the existing database and had to be obtained from other sources. Although the database was maintained on a computer, it was not maintained on a server as an online data network service and therefore, could not be remotely accessed from other workstations in the MNB(E) TOC or remotely from the NIPRNET or Internet. Providing an automated data network interface accessible from the Internet and NIPRNET would have offload some of the G5 burden of responding to requests for information and would have facilitated information sharing and dissemination in general. It would have also facilitated automated linkages to other relevant databases and the population of the G5 CMO database from remote sources.

The tactical support teams were key to the success of CMO in MNB(E). They deployed Monday through Friday into sector where they had direct contact with UNMIK, IO, and NGO personnel and with local civilians and leaders. The teams were assigned areas of responsibility

that allowed the same soldiers to visit the same villages, neighborhoods, civil administration, and business establishments. This served to build trust relationships and allowed team members to gain a first hand understanding of the local concerns, needs, and what works and what does not. The TSTs were also used to support MNB(E) QRF and special operations initiatives. A typical team consisted of an officer grade team leader (usually a major), one or two other officers, three sergeants, and a CAT-I interpreter. TSTs traveled in two to three vehicle convoys, had a Montero SUV, and several Humvees for deploying into sector. SINCGARS radios, GPS receivers, and *Omnitrac*s were mounted in the Humvees. Motorola *HT1000* and *TalkAbout*s were used for dismounted and convoy communications. They also had an INMARSAT capability. Civil affairs units, like others who deployed into the field, experienced poor line-of-sight radio performance in the mountainous terrain of Kosovo. Laptops and Palm Pilots were used for note taking and preparing situational reports. The team needed digital cameras to support documentation of HA project related activities and other events of importance to the MNB(E) mission, they were a passive intelligence collector. The CA tactical administration room at Camps Bondsteel and Montieth had SINCGARS base stations and DSN and NIPRNET access. The physical separation of the battalion communications and the commander who was located at the G5 section in the TOC presented operational challenges to communicate with the deployed TSTs. At Camp Montieth the administration room also had local telephone access for calling within the Gnjilane area. Local telephone service was not that good. When it was necessary to make commercial calls to Pristina and elsewhere outside of the Gnjilane area, one had to go to the telephone company office in Gnjilane to place the call.

The operations tempo of civil affairs was as hectic as the rest of the task force. They participated in the weekly command and staff meetings and met weekly with the targeting and information operations groups. They participated in the daily battle update briefings and morning intelligence briefing. The G5 representative briefed the status of the civil registration and HA programs daily at the evening battle update brief. LTC Beard represented civil-military operations at the weekly UNMIK sponsored regional four-pillar meeting in Gnjilane. TST team leaders participated in local UNMIK administrator meetings and the weekly joint security meetings chaired by the maneuver commander responsible for the area. Team members held regular meetings with local religious leaders, UNMIK, OSCE, NGOs, local mayors, business

leaders, and public utility managers. They represented Multinational Brigade East at the KFOR sponsored civil-military operations coordination working group held every two weeks. The CA commander held a weekly staff meeting with his G5 staff and TST members. The location of the meeting alternated between Camp Bondsteel and Camp Montieth. LTC Beard organized some bilateral meetings with the German CIMIC team to get a better understanding of how they do things and share information on current activities, which was a step towards building some cross-MNB collaboration.

As with other combat support units, civil affairs felt the force protection measures distracted from their roles and limited their ability to operate and move about the area. Flack vests, helmets, and weapons intimidated local civilians. It also made the TSTs indistinguishable from standard combat units and introduced inefficiencies into their operation. For example, a one person meeting required a two vehicle convoy and the rest of the team had to wait while the meeting was being conducted. Arriving in full battle gear did not send a signal of a safe and secure environment. The U.S. Army Special Operations Forces (SOF) liaison elements, also under OPCON of SOCEUR, were not constrained by the force protection rules. They attended many of the same meetings and dealt with many of the same local leaders as the TST members.

The CA support to the UNMIK pillars of humanitarian assistance, civil administration, institution building, and economic reconstruction was multidimensional. In support of the UNMIK humanitarian assistance (HA) pillar, civil affairs coordinated with NGOs and the international community to provide adequate shelter, clean water, food, and medical assistance. For UNMIK Civil Administration they assisted in the establishment of multi-ethnic governmental structures to perform civil service functions and public services such as sanitation, postal, and fire services. They also coordinated utility repairs for local individuals to get services such as telephone, water, and power restored to their homes and met regularly with local religious leaders to discuss issues and needs and coordinate activities to facilitate resolution. Institution building was the responsibility of the Office for Security and Cooperation in Europe (OSCE) and CA assisted OSCE in the democratization and institution building including human rights monitoring, organizing a judicial system, media development, training of local administrators, and organization of elections. Finally, the European Union (EU) was responsible for economic reconstruction,

but managing Kosovo's transition from a socialist to a market system had been problematic. EU suffered chronic shortfalls in money and staff. There was no light or heavy industry in Kosovo to provide jobs for the unemployed. Power plants only delivered 75 to 80 percent of the required electrical power and loss of power was frequent. The water system, whose pumps were also driven by the power system, was problematic as well. It was recommended not to drink water from the taps in the cities or elsewhere. In some cases, more water was being lost than was being used by the local populace due to broken pipes in major cities. It was not unusual to have the water shut off from 7 p.m. to 7 a.m. in cities such as Pristina.

The MNB(E) reconstruction efforts focused on conducting detailed damage assessments of industry, assisting development programs, identifying and activating revenue sources, coordinating utility reconstruction and manufacturing aid, as well as coordinating projects with IOs and NGOs. Efforts were also made to develop and fund labor intensive projects that would employ locals. The Village Employment Rehabilitation Program (VERP) was such a program funded by the EU and implemented by the U.N. Development Program. It focused on funding low cost projects that would hire unemployed locals in selected rural areas. Typical projects funded riverside cleanup, retainer wall construction and secondary road repair at a project cost of roughly \$25,000. CA also facilitated getting humanitarian projects for the TMK and recommended future reconstruction projects. The U.S. civil affairs approach to reconstruction projects was to facilitate, coordinate, and enable. This approach gave the locals buy-in and ownership in what they did. The main idea was to help them do it themselves instead of doing it for them. Managing a sizable number of HA programs that had a heavy focus on construction created high demands for engineering assistance. Although TFF engineers helped with the technical aspects of construction, facilities, public works, and related project assessments, they were often unavailable to civil affairs due to other operational demands. A few soldiers on the CA team had relevant expertise and were able to fill some gaps. It was felt that CA could do a better job staffing its teams with officers and enlisted personnel with relevant engineering skills since many of its reserve force soldiers have such skills in their civilian careers. Alternatively, funds could be made available in country to hire local general engineering consultants.

The approach of the other MNBs to CMO and reconstruction projects was not necessarily the same as the U.S. For example, the MNB(S) German-led brigade, reconstruction, and humanitarian aid were coordinated and channeled by a separate staff within the brigade headquarters and implemented by a specific task force called the Civil-Military Cooperation (CIMIC) Task Force. The MNB(S) sector was a rural environment with agriculture and wine being the principle sources of income. Industrial enterprises were few and unemployment was high, at 60 to 65 percent. Here too, as was the case in the rest of Kosovo, the family structure provided for the social security of each member. The German conscription program allowed them to review skill profiles and select candidates that were needed to meet their CIMIC staffing needs. They assisted in building over 30 schools and more than 960 houses, repaired roads and bridges, and were involved in more than 350 other projects such as building playgrounds and gymnasiums. More than 68 million DMs were spent for construction during the first year. As part of the humanitarian aid effort, about 960 tons of relief supplies were distributed, particularly to small villages in the mountains where other organizations did not go, due to rough terrain or the lack of media coverage of these areas. Their military field hospitals provided assistance for civil emergencies while CIMIC provided training for locals, such as teaching villagers how to repair tractors. Cooperation among more than 70 NGOs, UNMIK, OSCE, and UNHCR in the MNB(S) sector was problematic at the outset, but improved over time.

Following a field assessment in March 2000 (which identified that the international community lacked a capacity to assess reconstruction needs across Kosovo) planners at SHAPE set up a Kosovo development group (KDG). The KDG was under the authority of the European Union's Kosovo reconstruction department and reported to EU offices within the region. Belgium, Denmark, Finland, France, Germany, Greece, Italy, and Spain volunteered a staff of 18 non-CIMIC officers, who worked in teams of 3 in the province's 5 sectors. KDG teams traveled (in civvies not military uniforms) throughout the province, identifying and prioritizing reconstruction projects in cooperation with local authorities and about 120 NGO organizations. The projects covered all aspects of reconstruction, from repairing infrastructure to regenerating the economy. The cost of deploying the KDG was shared among the participating nations, KFOR, and the European Union.

Information sharing was problematic among the civil and military organizations as well as with the local population. As a result, KFOR and its Multinational Brigades established information centers rather than the traditional civil-military operations center (CMOC) or CIMIC Center in NATO parlance. The centers were placed outside the wire of the military compounds and located in the larger urban areas either in a separate facility or collocated with the UNMIK building used for municipal administration purposes. For example, in MNB(E), the Gnjilane information center was located in a building near the Serbian enclave. The other MNB(E) centers were collocated with the TST offices in the UNMIK municipal buildings in towns such as Strpce, Kamenica, Vitina, and Kacanik. For KFOR headquarters, instead of providing a CIMIC center, they provided a liaison officer to the UNMIK sponsored Humanitarian Community Information Center (HCIC) located in downtown Pristina. KFOR used the HCIC conference room for its civil-military operations working group meetings with the MNBs and participants from UNMIK and NGOs. The military centers were run by CA/CIMIC soldiers during weekdays and provided a visible presence of commitment and solidarity from KFOR and UNMIK. They also represented a non-threatening environment for citizens to voice complaints and request assistance.

The HCIC was staffed and resourced primarily by the United Nations Office for the Coordination of Humanitarian Affairs (OCHA). They were supported by the U.S. Agency for International Development (USAID), the UK's Department for International Development, Catholic Relief Services, International Rescue Committee (IRC), OSCE, World Food Program, and Save the Children. The center provided a database of local and international organizations working in Kosovo, advice and information to the humanitarian community, and disseminated information through its Web site (www.reliefweb.int/hcic/). Information was available in the form of reports, maps and geo-referenced data for which the place codes had been standardized and were compatible with *MapInfo* and *ArcView* geographic information systems. A database was being constructed on what organizations and agencies were working in specific regions and the services they were providing. The HCIC was very successful in facilitating the sharing of information in Kosovo.



Figure 1. TST Visit to Gnjilane OSCE Center

The OSCE began to open information centers as well. These centers tended to focus on helping local NGOs find opportunities. While visiting Major Lapage, U.S. Army and Gnjilane TST team leader, we did a walk through the town and found an OSCE information center that had just opened. We stopped by and they invited us in for a look around. There was a conference room on the second floor that could be used by the NGOs. Major Lapage (Figure 1) took the opportunity to explain his role to the office manager and discussed how civil affairs might help. He arranged for a follow-up meeting with them and suggested they provide him a list of NGOs and their capabilities so he might be able to find some tasks for them. As we sat around the conference table, someone noted that this was not the right professional environment for cutting deals. They felt it would be a much better approach if civil affairs could be authorized to wear civilian clothes and bring economic and financial planners to the table.

Strategic planning was a short fall in the Kosovo operation. There was no UNMIK strategic plan at the outset to focus, coordinate and synchronize the CMO efforts of UNMIK and KFOR and its MNBs and with the NGOs. Recognizing the importance of early synchronization of strategic vision, KFOR provided staff support to UNMIK to help develop

a strategic planning document. Additionally, the U.S. assigned Colonel Rich Roan, U.S. Marines, followed by Colonel Mike Dziedzic, U.S. Air Force, to UNMIK as the director's of strategic planning. Under their tutelage, a working draft of an UNMIK strategic planning document was issued in December 1999 with a second draft in the Summer of 2000. The UNMIK strategic plan was limited in scope and did not contain timelines and milestones for implementation. It was essential a list of things that needed to be done but this in itself was an important step forward. UNMIK also lacked the staff necessary to execute the plan.

The absence of a strategic plan was not limited to UNMIK. KFOR and the MNBs lacked plans as well. Broad civil-military cooperation guidance and intent was provided by KFOR to the Multinational Brigades along the CIMIC lines of operation that covered freedom of movement, humanitarian support, public safety, civil administration, infrastructure repair, economics and commerce, and democratization. Measures of effectiveness and end states for the lines of operation were not specified. In order to foster collaboration and cooperation, KFOR produced and disseminated daily CMO SITREPs based on reports provided from each MNB and the activities of KFOR headquarters. KFOR sponsored CMO meetings at KFOR headquarters every two weeks between CA/CIMIC chiefs to facilitate coordination, informing and consensus building. On the other hand, KFOR assessments of ongoing CMO activities were not always provided to the multinational brigades. A KFOR civil-military cooperation campaign plan was drafted during the first rotation of KFOR staff but it was never really implemented. Subsequent KFOR CIMIC officers had no knowledge that there even was a campaign plan. Attempts to resurrect the plan at KFOR J9 failed, mainly due to inadequate command emphasis. The KFOR record for passing on institutional knowledge during the transfer of authority between rotations had been in need of improvement.

There were many challenges in conducting tactical level civil-military operations, but the lack of a KFOR approved CMO plan that integrated and leveraged the activities of the MNBs was viewed as a major shortfall of the operation. The MNB(E) G5 in his after action review reported that tactical level CMO activities within MNB(E) were hampered by the absence of an overarching KFOR campaign plan and means for measuring the status and effectiveness of the CIMIC lines of operation at the municipal and maneuver unit levels. Additionally, there was no overall CMO campaign for MNB(E) either. As a result, the CMO activities

were not fully integrated and synchronized with KFOR and other Multinational Brigades, or within MNB(E) elements and maneuver units. Many of the CMO activities were more reactionary than deliberately planned and synchronized to attain an overall objective. Reports requested by KFOR and the CIMIC sponsored meetings were primarily used to inform themselves, the MNBs, and other organizations, such as UNMIK, of activities within the KFOR and respective MNB sectors not to manage the CMO program.

Although UNSCR 1244 required that the “international security presence with substantial North Atlantic Treaty Organization participation must be deployed under unified command and control,” the balkanized approach to civil-military operations in KFOR was representative of the lack of overall unity of effort for NATO forces in Kosovo. KFOR headquarters was a coordinating rather than a command and control headquarters. The MNBs were relatively independent and had approaches to civil-military operations that were more indicative of national political priorities and military operating styles. In addition, national contingents often sought to involve NGOs or government sponsored relief agencies from their own countries or regions rather than treating UNHCR as the designated lead agency for relief coordination. Beyond inappropriate use of resources, this sort of favoritism affected the impartiality of the military. On the other hand, there were occasions where CA/CIMIC assistance helped steer clear of excessive village chief and clan involvement in the selection of relief based on local politics rather than need. What was missing was an overall civil-military operations strategy and campaign plan. As a result, the CMO strategy became driven from the bottom up. This approach lacked unity of effort and ran the risk of missed opportunities, misuse of resources, duplication of effort, unintentionally legitimizing certain behavior, and empowerment of local leaders and organized crime elements.

The MNB(E) maneuver unit’s focus was to provide a safe and secure environment. In executing that mission they performed CMO related activities, such as sponsoring town meetings and coordinating with IOs and NGOs. The focus of the civil affairs teams was to perform extensive civil-military operations activities to support the Task Force Falcon commander’s intent and the maneuver units in their area of responsibility. The potential for disunity of effort existed because neither civil affairs nor the maneuver units had been provided phased objectives with means to measure the effectiveness of civil-military activities.

The civil-military operations conducted by the tactical support teams contributed significantly to influencing the behavior and attitude of the local leaders and community. The TSTs operated in all maneuver battalion task force sectors to coordinate civil-military projects and humanitarian assistance. A year earlier, many local Serbs viewed KFOR as evil. Through the good efforts and actions of civil affairs to prove KFOR was there to help, the local population attitude changed substantially, especially in the Serbian communities. Many examples of positive things civil affairs did have been cited in articles in the *TFF Falcon Flier*, NATO press, international press, and elsewhere. I personally witnessed many while on mission with several of the tactical support teams. For example, while visiting Major Ricci, U.S. Army and TST team leader in Kamenica, a Serbian man approached us when we arrived at his office at the UNMIK building. The man was there to seek help in getting his telephone service restored. The word was out that Major Ricci and civil affairs had taken an action with UNMIK that directed the local telephone company to restore the telephone lines that had been cut to the Serbian enclaves. Power and water companies had become responsive as well. Major Ricci took down the man's phone number and passed it to UNMIK for action. It turned out that Major Ricci spoke a little Serbian. When Serbs came to him with problems he could talk to them a little, which helped a lot in building trust. With the word out that CA was helping, people were waiting at their office door every morning to get assistance to help solve problems or they stopped team members in the street.

MNB(E) had Greek, Russian, Polish, Ukrainian, Jordanian, and UAE units assigned to it, which offered an opportunity to gain some operational experience in working with a foreign military force. It also presented some cultural, procedural, and language challenges. For example, the Russian contingent spoke little English. There was an underlying hostility from the K-Albanian population towards the Greeks and Russians. The Greeks and Serbs shared an Orthodox background in contrast with the K-Albanian Muslim background. The decision of the Greek government to openly oppose the NATO air campaign also added distrust. Russian alignment with the Serbs created a strong distrust of them from the K-Albanians. In fact, the Russians were frequently attacked in their MNB(E) sector, endangering U.S. soldiers as well. Civil affairs teams played an important role in trying to build trust in these sectors by demonstrating solidarity between the U.S.,

Greek, and Russian forces. U.S. forces conducted joint patrols with Greek and Russian forces in their sectors. The U.S. conducted joint cordon and search operations as well. Greek and U.S. forces combined efforts for humanitarian assistance, treating Albanian patients, and visiting schools together. The civil affairs team leader often accompanied the Greek commander when he attended civic events and spoke with the local media. The Russians were somewhat fascinated with civil affairs and attempted to put together their own program. Joint U.S. operations with the Russians, such as security escorts and deliveries to medical clinics, legitimized the KFOR commitment.

Civil affairs teams went into towns and looked at the state of the infrastructure, including public works, sanitation, financial status, education, and limited administrative services. They assessed the situation, looked at the available resources, and then tried to help the locals plan projects to improve the situation. Many local leaders seemed to lack the basic skills that are needed to lead, manage, and guide progress in a peaceful society. The Albanian leaders were taking every opportunity to further their cause. At municipal meetings they didn't want to focus on problems, but on political issues. Nepotism ran rampant. Most local people getting jobs in the municipalities were not qualified, had their own agenda, and the ones in position of authority gave jobs to family members. For example, the Vitina civil administration was behind most Opstinas in MNB(E). The previous UNMIK administrator was reluctant to populate municipal positions because he knew the history of personnel using their positions to promote their agendas. Civil affairs provided some material and facilities for educating the emerging provincial leaders. The efforts required a lot of time negotiating and conducting face-to-face meetings with the community leaders, managers of small businesses, UNMIK representatives, and international organizations such as the Red Cross, the World Food Program, and CARE. The CA leaders and maneuver commanders often had to craft a compromise between competing points of view that carried the day and ensured the peace.

The tactical support teams earned trust, built good rapport with the local people, and spoke informally with them to pick up details that didn't emerge from the more formal discussions. CA tried to get contracts for small companies with Camp Bondsteel and attempted to identify projects that would bring people together. While visiting with Captain Barwikowski, U.S. Army and TST team leader in Vitina, I witnessed the

signing of a contract (Figure 2) with some local workers to install speed bumps along the main street of Vrbovac. Civil affairs coordinated the hiring of local nationals. Though difficulties did arise with the workers and the quality of work, problems were resolved, and the residents of Vrbovac were happy with their new speed bumps.



Figure 2. TST Signing Contract for Speed Bumps

Captain Barwikowski also told me about the “great potato deal.” Serbian farmers had been unable to sell nearly 200 tons of potatoes harvested last fall. The tactical support team contacted the agricultural co-op in Vitina to coordinate the sale of 40 tons of potatoes to Albanians. This was a first for Albanians buying Serbian produce in large quantities. The TST was also instrumental in helping some Vitina Serbs get hired by Brown and Root, who had previously hired Albanians due to Serbian concerns for personal security. The 101st Airborne set up its operation in an old fan factory on the edge of Vitina. There were jobs available in the dining facility as well as custodial work. Working with Brown and Root human resources, the civil affairs team worked out an arrangement where by the Serbs could be hired to work the night shift. In another example shared with me, the Vitina TST coordinated a local contract to repair a school that had been torched by Serbian soldiers before KFOR arrived. The team provided school supplies, coloring books, and crayons to local schools as well. LTC Miles, U.S. Army and commander of the 1-187 Infantry, was responsible for the Vitina area and held a weekly joint security committee (JSC) meeting at the UNMIK building

in Vitina. For this meeting, the TST team leader participated with the UNMIK administrator, NGOs, and local representatives from the Serbian and Albanian community. The Serbian representative rarely attended. As a result, the TST worked with the local Serbian church leadership to help address Serbian concerns in the Vitina area.

TST and G5 representatives attended the TFF weekly operations planning and targeting meetings to try to help synchronize CMO with the maneuver and information operations plans. They were also helpful in providing ground-truth insights on the current situation in sector and changing trends within the local community. They had contacts with local civil, political, and religious leaders, and could provide perspectives on likely reactions of these leaders to events and actions taken by MNB(E). CA personnel worked with the information operations cell to help them capture the specifics related to civil-military projects and humanitarian assistance successes in sector. This information was then included in press releases, PSYOP products, and information operations talking points, which were used to persuade the populace and local leaders of the benefits of cooperating with MNB(E). The CMO activities were not specifically integrated with the information operations effort, except in those instances when sanctions were imposed on specific communities. KFOR civil-military projects and humanitarian assistance were withheld to send specific messages to a community. For example, sanctions were imposed in Kamenica and Strpce in response to civil disturbances.

In addition to standard civil-military projects, such as repairing utilities and school construction and repairs, CA personnel also coordinated small-scale employment projects. Local business rehabilitation was sponsored as well as interethnic business cooperation. While visiting Major Bob Albanese, U.S. Army and TST team leader for Kacanik, we stopped by a soft drink bottling plant to see if there might be a way to link them up with an U.S. State Department small business investment opportunity. Initially, the Kacanik civil affairs TST office and living quarters had been located in the Polish headquarters building, until for force protection reasons they were not allowed to stay overnight and had to return to Camp Bondsteel. The Kacanik TST office and information center are now located on the first floor in the UNMIK municipal building and the team travels to Kacanik daily. The UNMIK administrator in Kacanik was very good. He got out to the towns in his area to understand the situation firsthand. The UNMIK building,

including OSCE offices, was next to the Polish battalion headquarters that was collocated with UNMIK police in an old MUP building. The TST made daily trips to Kacanik from Camp Bondsteel. UNMIK occupied the first floor and some local government staff funded through UNMIK occupied the rest of the floors. The locals wanted more people put on the payroll, like the old style communist system. However, UNMIK could not afford to fund a larger staff. Although they employed 5 locals, they were still in need of help. KFOR, USAID, DRA, and other organizations funded or provided material for reconstruction projects in the Kacanik area.

Major Albanese was a schoolteacher when not on a civil affairs assignment. He was interested in helping the Kosovo school system in the Kacanik area but thought it needed structure and discipline. For example, an 80K DM investment was made in refurbishing a school in Kacanik, but there were already signs of destruction by students and the teachers didn't seem to want to take any accountability or corrective action. The Serbs had suppressed the Albanian school system so many children were taught at home. As a result, structure, discipline, and lesson planning were not a part of the newly established Albanian school system and culture. Students were sometimes in class for a one-half hour before a teacher showed up. Little lesson plan development was done. They have not had a formalized system in place for a long time. Major Albanese talked to the director of the Kacanik school system about taking procedures from his school district in New York and modifying them for their use. At that time, grades 5 through 8 used the school in the morning and grades 1 through 4 in the afternoon. There was a high school that went to grade 12, but it could go longer for what we would refer to as vocational school. The director of the high school had 15,000 DM to invest in school improvements. He spent about 7,000 DM for painting fences and outside improvements, instead of making the inside structure more pleasing for the students by patching holes and windows. There was no quality control of the construction and no controls on the use of the money the director was given for improvements.

Humanitarian assistance efforts by the TSTs included escorting Kosovar Serbs to medical and other social welfare visits in or through Kosovar Albanian communities, coordinating for food, clothing, and medical assistance distributions to specific families and communities. While visiting the TST at Kacanik, we distributed blankets and pillows to the town of Kerbliq.

As noted earlier, TSTs were also used to support MNB(E) QRF and special operations. For example, they were deployed to try to help convince local residents to take down UCK monuments in Petrovce and Kamenica. They were also called upon to try to help defuse possible further civil disturbances following the vandalism of the UNMIK office in Strpce. I accompanied Major Rob LeValley, U.S. Army and TST team leader for Strpce, on a visit he made the day after the Strpce office was vandalized. He interviewed locals about the incident and talked with the Polish brigade commander and the local UNMIK police chief to try to get a sense for whether there might be any further disturbances. We also witnessed a Serbian-led demonstration that set up a roadblock to express their concerns about the lack of KFOR action to find a missing Serbian shepherd who they believed had been kidnapped and possibly killed by some ex-UCK soldiers the locals they claimed to have seen in the area. A few days later the shepherd was found dead in the woods near Strpce. Following the accidental shooting of a 6-year-old boy by a KFOR soldier near Vitina, TST members were on the scene to monitor the crowd and keep them informed of the situation surrounding the shooting. Team members provided emotional support to the family following the boy's death. When two Serbs were reportedly abducted in Domorovce, TST members were deployed to monitor and defuse local resident demonstrations and protests. In Kamenica, some 3,000 Albanians celebrating the illegal renaming of the town and unveiling of a UCK monument started throwing rocks at Russian forces when they were told they could not affix a UCK plaque to the monument. TST members supporting a QRF team intervened and were able to calm the situation by negotiating with Albanian leaders they knew. Getting to know the villages, their residents, and particularly the leaders, cannot be underestimated. TST members were quite effective in building local trust relationships and legitimizing the commitment of KFOR.

The KFOR appreciation day gathering in Gnjilane was another example of using TSTs to get out and test the pulse of the community during special events and to resolve conflict. The Gnjilane event included traditional ethnic Albanian dancing, songs, and speeches, and was held in the center of town. Although organizers and KFOR estimated the turnout to be very large, only about 6,000 people actually attended the event to thank American KFOR troops for their role in bringing peace to the province. The event was organized by the LDK political party but was not sanctioned by UNMIK or KFOR. KFOR troops provided security protection. The roads into the center of town were

blocked and there were plenty of checkpoints and infantry walking around. The celebration was very peaceful. There were also UNMIK police and KPS police around the area. SOF team members were seen in the crowd as well as in the cafés. This was also the first event and first day in the driver's seat for the 2-2 Infantry who replaced the 1-63 Infantry. I accompanied LTC Beard, Major Lapage, and other members of the Gnjilane TST for a walk during the height of the celebration.

TSTs and G5 staff received no pre-deployment training for their role in support of information operations. The G5 participation in the targeting process was viewed more as support to information operations than using civil-military operations as a weapon of choice for meeting the TFF commander's operational priorities and objectives. In the absence of a CMO campaign, there was a need to better link CMO activities with TFF objectives and the information campaign. This was especially true for the information operations talking points. The TSTs viewed the talking points as an excellent idea for delivering KFOR messages with one voice. It was felt that those developing the talking points needed to spend time in the field to gain a better appreciation for life outside the wire in order to improve the credibility of the messages. Members of the information operations cell did take some measures to get out with the civil affairs and PSYOP teams and maneuver units to develop some first hand experience and understanding of the situation in the field. Sometimes there were conflicts between TST views and those expressed in the talking points. The TSTs felt they had a better understanding of ground truth. This led to concern about being too restrictive with the use of talking points and not allowing the TSTs and other with direct contact with the locals to have more flexibility and discretion in dealing with locals on key issue areas.

Reporting was a major activity of the TSTs daily tasks. Situation reports, village assessments, spot reports, and results of discussions and reactions to the use of the talking points were typical information that was collected and provided to MNB(E). A frequent problem was that TSTs were often asked for information that they had previously reported to MNB(E) headquarters elements. Additionally, little information ever came back down from higher organization levels. There was a concern on the part of the TSTs that information was not being reviewed, assessed, assembled, and distributed in a way that others could access and use it. Many felt that the MNB(E) process may have been more cut and paste reporting that became shelfware. On the other hand, the daily KFOR

CIMIC report was quite well received and provided useful information on UNMIK and KFOR civil-military operations activities. The report served to inform the civil-military community in and outside of Kosovo, as well as promoted CIMIC legitimacy and unity of effort among the civil-military players within Kosovo. Unfortunately, the more open dissemination to UNMIK and civilian agencies outside of Kosovo had to be stopped. This was due to a NATO policy that states any NATO document, regardless of classification, is not releasable to non-NATO entities without the expressed permission of the North Atlantic Council.

Pre-deployment training included participation in a five-week language training course in either Albanian or Serbian. The language training included some instruction on basic aspects of the social culture in which the soldiers would find themselves. Some soldiers with Hispanic background actually picked up Albanian quite quickly once in country. Once onsite, the fact that soldiers were trying to learn basic language skills had positive effects of helping to break the inner barriers of the local Albanian and Serbian cultures. As was noted by other units, however, the CRC/IRT training was less than satisfactory. It implied that Bosnia and Kosovo were the same, when in fact they were not. Every Kosovo AAR emphasized the point “Kosovo is not Bosnia,” yet the pre-deployment training had not yet adapted to this point. There was no Kosovo block of instruction per se. Frequently instructors would say, “when I was in Bosnia,” while discussing issues about the situation in Kosovo. The civil affairs unit also did not participate in an MRE, so the leadership learning curve was fast and furious when they hit the ground in country. Although the CA units had soldiers with Balkans experience, they did not necessarily have Kosovo experience. Nor did they have an understanding of how Task Force Falcon operated, including the battle rhythm. Trust and confidence were essential elements of team building, as well as timely integration of the teams into ongoing operations.

Per discussions with LTC Holshek, U.S. Army and KFOR liaison to UNMIK, one of the most valuable Kosovo civil-military operations lessons at the KFOR level was that it was more important to have adequately trained and qualified personnel than it was to have up-to-date doctrine. Soldiers often forget doctrine, but they less often forget the training that shapes their instincts in the field. The after action reviews tend to overly focus on doctrinal changes. The real issue is whether soldiers on the ground actually read or apply the doctrine, or

even are aware of it. For example, LTC Holshek noted that six months after publication of the latest version of FM 41-10, U.S. Army civil affairs officers at KFOR headquarters were not even aware that it had even been published, let alone obtained a copy. It was also pointed out that the most elegant and sophisticated doctrine is hardly useful to the uninitiated. The field is not always the place to learn basic theoretical concepts of CMO, although it is an ideal environment to reinforce them. As implied above, doctrine rarely fits every practical application, especially U.N.-led international peace operations. CMO doctrine in particular has barely been able to keep pace with the rapidly evolving and complex realities of peace operations over the past few years. This has been evidenced by both U.S. Army Civil Affairs and Psychological Operations Command (USACAPOC), and SHAPE in their difficulties in updating their doctrinal references. In the final analysis, training closes the gap between doctrine and operational reality.

Peace support operations tend to be mainly led or conducted by civilians, especially in transitional civil administration situations. Thus, the skill set requirements for the military CA/CIMIC forces have been radically altered. Holshek noted that the good news is that the requirement for CA/CIMIC specialists to perform nation-building is diminishing. The bad news is that the demands on CA/CIMIC generalists, particularly at the operational level, are increasing rapidly. The kind of people required to perform or coordinate operational level CA/CIMIC (for operations such as Joint Guardian) must possess greater peace support operation knowledge, combined/joint staff experience, CMO-related training and skills, political and cultural sensitivity training, and oral and written communications skills (usually in the English language). They must be solid staff officers and know something about risk assessment, and mission and course of action analysis. Beyond this, they must be knowledge and information managers and basic public administrators, logisticians, engineers, legal, and law enforcement specialists, and educators. They also need to be skilled at networking and coordinating in a multinational operational environment. The CA/CIMIC soldier today, in addition to the structured CMO training, must also possess interpersonal skills and an openness and sensitivity to their mission that cannot be taught. It is an art, not a science. They must be enablers as much, if not more, than technical experts. Between the military and civilian worlds they simultaneously inhabit, they must be engines of synergy, fueled by knowledge and information. They may not know all the answers, but they should at least know how to

find them. Thus, the effectiveness of the military team on the ground ultimately comes down to the quality of the participants. CA/CIMIC military force providers like SHAPE J9 and USACAPOC must now concentrate even more on making sure the people they select to perform operational and tactical level civil-military operations are the right kind, with the right background and the right training, for the right phases of the mission.

There is a historical reality related to the introduction of a non-traditional military role such as CMO into a traditional military warfighting force. There is the danger of developing a non-integrated subculture, or a CMO ghetto, within the deployed military community. This was certainly the case in the early days of CA/CIMIC activities in Bosnia. Admiral Smith, U.S. Navy and IFOR commander, made the comment upon his departure that “he didn’t know what civil affairs was when they first arrived but now he can’t do without them.” As LTC Holshek put it, even the best-trained and most experienced CA/CIMIC officers have three strikes against them when they first report to many of the commands and commanders they support. First, they are not one of them (meaning they are either not in a combat specialty, not from the commander’s unit, and/or are a reservist). Second, they are involved in something many commanders don’t inherently understand and feel uneasy about, referred to as mission creep. The third strike is when a CA/CIMIC officer asks what he ought to be doing, rather than explaining what he can do to support the force and the extended mission (which implies an ability to conduct mission analysis and understand the CMO mission). Therefore, the first CA/CIMIC mission is to establish legitimacy with the supported command and commander. The untrained, unqualified and inexperienced CA/CIMIC officer is not as likely to be able to explain the value added and convince the commander that the CA/CIMIC team will be a force multiplier and an enabler to his operation.

For U.S. Army Reserve civil affairs forces, real world peace operations deployments are particularly challenging. Unlike most other Army Reserve forces, Reserve CA units are not afforded the usual two-week annual training (AT) exercise. This is the time during which the entire unit deploys to a military training center to conduct training in common soldier skills and other U.S. Forces Command or USACAPOC training required for deployment readiness. This leaves the typical Reserve CA unit commander with 48 unit training assemblies in 12 weekend drills per year, with an average of 60 to 70 percent attendance on a given drill

weekend. The challenge is for the CA commander not only to maintain readiness in these basic deployment readiness skills, but also to provide training in refreshing and improving the civil affairs skills for which they are needed.

USACAPOC provides great emphasis on doctrinal development and one time CA qualification training at Ft. Bragg, North Carolina. However, once initiated at Ft. Bragg, CA training involves rather perishable skills that cannot be updated solely through publications of updated doctrine. A careful review of USACAPOC training requirements for CA forces should look to streamline training requirements to cultivate skills that bring the most value-added to field operations. In this regard, USACAPOC could develop adaptable training modules or packages that enhance training for the emerging operational CA skills now needed rather than functional specialists in nation building. It should also consider sharing some of the training innovations of its units throughout its command. The 304th Civil Affairs Brigade has now run two mini-AT events on extended weekends at Ft. Dix, NJ. The events are intended to maximize opportunity, and to train as many of its soldiers as possible in basic deployment related skills. Training preserves the AT option for its soldiers, as well as opens many more options for CA intensive green-phase training throughout the remainder of the training year. Its headquarters company has implemented a system to group additional duty assignments in teams along mission and training lines to build leadership, improve training quality, and overall skill levels. There are many other such initiatives occurring across the CA community, which could be shared on a Web site. Distance learning tools and virtual simulation environments could be employed as well.

LTC Holshek noted that USACAPOC could explore implementing the U.N. Association of the United States recommendation that stated, “the United States, should renew the offer made by President Bush in 1992 to make Fort Dix, NJ—within easy driving distance of both United Nations headquarters and Washington—available for U.N. training of earmarked contingents.” Besides supporting this idea, USACAPOC could take a step further by offering to run an international CIMIC training center (ICTC) to train in civil-military cooperation in international peace operations. There is also a potential opportunity to help create a research and analysis center on international CMO as well. In regard to the latter two points, the Canadians have such a training and research facility at the Lester B. Pearson International Peacekeeping Training

Center in Nova Scotia. The Pearson center trains international civilians and military peacekeepers in a wide range of peace support operations skill areas, as well as conducts research into peace support operations. The George Mason University Program on Peacekeeping Policy co-sponsors an annual workshop with the Pearson Center, referred to as the Cornwallis Group, that brings together civil and military personnel with real world peace operations experiences and those concerned about the use of international forces and organizations in interventions. The focus of the workshop is to educate and explore ways to enable these forces and organizations to work together. There may be a possibility for other collaboration initiatives with the Canadian activity as well. Such a training capability could afford the opportunity for all CA and PSYOP battalions to rotate through an ICTC and test and upgrade civil affairs and peace support operation skills before deployment. The program would operate much like combat maneuver units, which rotate through the National Training Center in the U.S. or the U.S. Combat Maneuver Training Center in Germany. These soldiers obtain tremendous return on investment and training value-added.

In spite of many obstacles, civil affairs made a number of significant contributions to the success of the first year of MNB(E) operations. Over 500 detailed village assessments were conducted and documented. These assessments consisted of information and evaluations of food, water, sewage, sanitation, medical facilities, schools, religion, roads, transportation, electricity, governmental organizations, communications, public safety, key leaders, and more. TSTs forwarded their assessments to the G5 for database archiving, tracking, and distribution. Several village employment and rehabilitation program pilot projects were implemented and as a result of the success of these efforts, about 800,000 DM were obtained for additional projects. Utilizing a DoD funding source for \$5 million, the civil affairs element was able to fund over 250 humanitarian assistance projects such as school repairs, electrical power grid and water treatment plant repairs, urgent humanitarian housing needs, and repair and replacement of fire and sanitation trucks. For example, streetlights were replaced in Kacanik where in addition to locating and procuring the right light bulbs, the TST needed to borrow a cherry picker to be used to replace bulbs in the lampposts. The Polish, Greek, and U.S. forces engaged in adopt a school program that provided much needed repairs and supplies. TSTs facilitated the spring planting season by coordinating NGO distribution of fertilizer and seed to local nationals and also helped coordinate the

repair and procurement of planting machinery. CA teams helped delivered 12 tons of humanitarian assistance aid and assisted in over 150 MEDCAPs/DENCAPs and medical training. CA assisted the UNMIK and OSCE Joint Registration Task Force. They coordinated daily with UNMIK, NGOs, international organizations, and local leaders. Labor and employment initiatives were conducted at the Glama Quarry, Gllamica Quarry, and Intregj Factory. CA also coordinated contracts with local companies to install speed bumps to slow down speeding drivers through villages.

CHAPTER XXII

Information Campaign

Larry Wentz

Information Operations

Information operations, led by KFOR headquarters, was essentially an information campaign that supported the KFOR mission and promoted the successes and credibility of UNMIK and KFOR in Kosovo. The Multinational Brigades' information operations took on different forms—there was no consistency in implementation across KFOR and the MNBs. In the U.S.-led sector, the U.S. concept of information operations as an integrating strategy drove MNB(E) information operations. It was therefore an effort to integrate the activities of various commanders, staff elements, and soldiers from the MNB(E) headquarters and subordinate U.S. and multinational battalion forces.

The lack of a strategic end state for Kosovo and overarching strategic plan to guide and help synchronize the information operations efforts resulted in multiple and loosely connected information campaigns occurring simultaneously in Kosovo. Information operations were still in its formative stages in NATO, so doctrine differed.

MNB(E), and the U.S. element in particular, was the most proactive in implementing information operations as an integration strategy. The approach employed was more than simply a public information campaign. There were both offensive and defensive aspects to MNB(E) information operations. The defensive aspects included operation security (OPSEC), information assurance and protection, and monitoring disinformation and propaganda. A Field Support Team (FST) from the U.S. Army Land Information Warfare Activity (LIWA) was used to support conducting information operations efforts in the MNB(E) region. The LIWA FSTs primary functions were planning, targeting,

overseeing, monitoring information operations execution, and conducting information operations assessments for the brigade. U.S. Army tactical information operations doctrine was the basis for the intelligence preparation of the information environment. This supported the military decisionmaking process, targeting process, and execution of operations by centralized planning and decentralized execution. The 1st ID and 1st AD had different approaches for executing information operations. The 1st ID used the LIWA FST team chief as the MNB(E) IO officer and at the battalion level, IO was just one more duty assignment. With 1 AD deployment, the Deputy Fire Support coordinator was appointed MNB(E) IO officer and the battalion Fire Support officers were appointed IO officers. This action provided a technical hierarchy as well as chain of command to ensure that the information operations tasks and responsibilities were executed.

Information operations in Kosovo strove to garner international support, influence essential Kosovo decisionmakers, and shape the local attitudes to behave in manners that supported KFOR soldiers and operations. The effort focused on providing operationally relevant information to leaders and the population, rather than managing perceptions. KFOR relied on Public Information, PSYOP, civil-military cooperation, and the Joint Implementation Commission. The MNB(E) information operations weapons of choice were the maneuver battalions, public information, PSYOP, civil affairs, special operations, and the JIC. Special services such as military escorts for Serbs, MEDCAPS, and DENCAPS were employed as well. KFOR use of disinformation, propaganda, and deception were not allowed, but this did not necessarily apply to national campaigns. Only white PSYOP was employed by KFOR and there was no counterpropaganda campaign in spite of extensive use of propaganda by the Serbs. Disinformation and propaganda flowed into the sector from various sources, including media sources within Kosovo as well as external to the province in Serbia and Albania. Word of mouth from travelers throughout the region and sector constituted a large source of disinformation. Propaganda in Kosovo tended to be very simplistic and obviously contrived. Serbian propaganda lacked credibility with the local population, especially ethnic Albanians. There was also disinformation on the Internet. KLA-FOR Online (<http://www.kfor-online.com/>) was an example of a Web site that was a spoof of the KFOR and NATO official Web sites. It depicted the U.N. SRSG and the NATO Secretary General as Nazis, and lauded the

successes of the Albanians with NATO's help to get rid of the Serbs in Kosovo. Direct refutation of propaganda only served to give it credibility. Instead, the KFOR campaign targeted areas such as promoting a safe and secure environment, deterring violence and criminal activities, encouraging a free and open society, promoting a positive UNMIK and KFOR image, and mine and UXO awareness. The target population was mainly 20 to 50 year olds and was a mix of Romas, Turks, Albanians, and Serbs. In Bosnia, the German PSYOP product *MIRKO* specifically targeted teenagers and was one of the more successful products produced by the IFOR/SFOR information campaign. There was no such product for Kosovo and little effort addressed teenager needs.

When I visited the KFOR information operations cell in Pristina in June, COL Bill Carter, U.S. Air Force, had just taken over. The activities of the KFOR information operations cell focused on planning, coordinating, collecting data, and analyzing the effectiveness of the KFOR information campaign. The information operations cell was also responsible for assessing all information-related activities of the KFOR headquarters operation and advising COMKFOR accordingly when conflicts arose, or if there was a possibility of improper use or release of information. The information operations cell reported to the Assistant Chief of Staff for operations and consisted of a PSYOP support element and an IO coordination section that consisted of current operations and long range planning.

There was a KFOR Joint Information Strategy cell, consisting of the IO cell and the Combined Public Information Center (also referred to as the Coalition Press Information Center or CPIC). The strategy cell brainstormed with the KFOR CJ heads to find avenues, methods, and messages for executing the information campaign. One of the concerns at the time was the inability to convey information, since the Kosovo national information infrastructure was dysfunctional. They focused on areas such as promoting KFOR successes, democratization, refugee returns, and law and order.

There were several KFOR working groups used to coordinate information operations activities. A weekly KFOR headquarters information operations working group meeting was held at the Humanitarian Community Information Center in Pristina with UNMIK and NGOs. There were two weekly working groups held with the MNBs

where NGOs were also invited, but usually did not attend. The chief of the KFOR information operations cell sponsored one of the weekly information operations working group (IOWG) meeting that rotated among the KFOR and MNB headquarters locations. The other was a PSYOP working group that met after the information operations working group. The KFOR IOWG was used as a way to facilitate KFOR-MNB collaboration and coordination, share insights on activities being pursued, share information operations tactics, and to deconflict activities where possible. In reality, the working groups focused on consensus building rather than directives, and MNBs only shared some the things they were doing in their sectors. The meetings also provided an opportunity for the KFOR and MNB information operations team leaders to network.

I had the opportunity to attend the KFOR IOWG held the first week of June at MNB(S) headquarters in Prizren. Participants included U.S., UK, Germany, France, Italy, and Spain. The main subjects of the meeting were the upcoming local celebrations being planned for the anniversary of KFOR, safety of the local population (particularly children), and the registration progress. COMKFOR instructed the MNBs not to participate in any anniversary celebration that was not sponsored by KFOR or UNMIK. Two official activities were scheduled, one of which was a June 11 UNMIK-sponsored celebration at the headquarters building in Pristina. On June 12, there would be a joint UNMIK and KFOR press conference where there would be a presentation on UNMIK-KFOR activities, short statements by the U.N. SRSG and COMKFOR, and a Q&A session. The KFOR 1st Anniversary information campaign, which was still in development, would focus on informing the public of KFOR and UNMIK accomplishments. The MNBs were requested to provide KFOR vignettes on accomplishments in their region. The safety campaign had several aspects. The new Kosovar passenger train service would be opening in June and there would be a charge. The information campaign needed to make the public aware of this, but more importantly, to make the children aware of the train operation since they played frequently on the tracks. With school ending for the summer, COMKFOR was concerned about children's safety from cars and landmines. The campaigns continued to emphasize road safety and mine awareness. The registration was moving too slowly, so the OSCE asked KFOR to help inform the public by putting up OSCE produced election posters in the Serbian enclaves. An OSCE contractor would take care of the

rest of Kosovo. KFOR would be putting an information campaign package together with the help of MNB(E) to address freedom of movement for Serbs, mine awareness, and the registration process. The rest of the meeting was devoted to the MNBs reviewing the focus of the previous and upcoming week's information operations activities, sharing initiatives, and discussing issues in their sectors. For example, MNB(W) shared their success with using T-shirts and ball cap handouts at sports events, as a way to attract people to come and listen to the mine awareness presentations. MNBs emphasized the need to do more joint operations and to continue to improve cooperation with UNMIK police and the Russians.

KFOR and the other MNBs did not conduct information operations like MNB(E). The MNB(E) information operations activity was a well-structured process with direct commander interest and involvement. It also brought all of the task force team into the planning and execution. LTC Smith, U.S. Army, was the MNB(E) information operations officer, supported by the LIWA FST led by Major Brown, U.S. Army. The information operations cell reported to the G3 and was located in the G3 plans area of the TOC. Collocation with G3 plans shop ensured that information operations were integrated into all of the plans and allowed the information operations cell to interact with other battle staff on information operations related matters.

The MNB(E) information operations cell participated in and chaired various meetings with the commanders and staff, the KFOR information operations cell, and KFOR IOWG. MNB(E) had its own internal information operations working group chaired by either the information operations officer or LIWA FST Chief. The MNB(E) IOWG served as a forum to exchange information among representatives of the primary staff elements and units involved with conducting the brigade's offensive information operations. The purpose of the information exchange was to coordinate and synchronize the execution of information operations in sector for the upcoming week and to obtain evidence to support accurate assessments of the brigade's IO efforts. The conduct of the various meetings comprised the IO cell's battle rhythm (Figure 1). These meetings were the initial targeting meeting, the target development meeting, the MNB(E) IOWG, the MNB(E) assessment meeting, the KFOR IOWG, the executive targeting meeting, and the commander's decision briefing. A target synchronization matrix directed and synchronized information operations engagements of

specific leaders and population groups in the sector. An information operations execution matrix was used to assign tasks to headquarters assets and subordinate battalions.

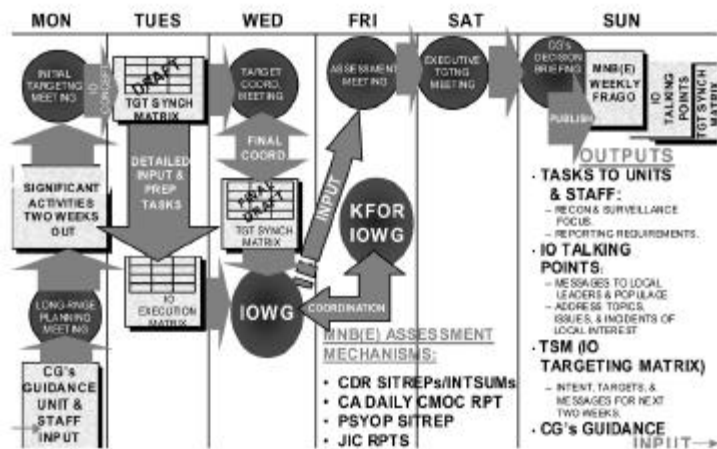

Figure 1. Information Operations Battle Rhythm

The IO cell prepared talking points for senior task force leader discussions with local leaders and supported the Crisis Action Cell (CAC) and QRFs when needed. Additional duties of the MNB(E) IO officer included assisting the OPSEC officer with defensive IO, assessing information-related activities of MNB(E) from an information operations perspective and information protection planning.

UNMIK, OSCE, KFOR, and MNB approaches and products included use of newspapers (including KFOR and MNB funded inserts for local papers), magazines, posters, handbills, radio/television, press conferences and releases, and Internet Web sites. Unlike the Bosnian newspaper *Herald of Peace*, which was published as a single paper in two languages, separate Kosovar newspapers were produced in both Albanian and Serbian languages. UNMIK published the *UNMIK News*, OSCE the *UPDATE*, UNHCR the *Humanitarian News*, KFOR the *KFOR Chronicle*, and at the MNB level the U.S. produced the *K-Forum* and *Falcon Flier*. KFOR also produced a monthly magazine the *Dialogue*. KFOR and the MNB PSYOP teams used posters and handbills extensively (Figure 2) for focused activities, such as land mine and UXO awareness.



Figure 2. PSYOP Product

KFOR and MNB(E) both funded radio stations and television programming. They used these media to provide Kosovo with popular music, KFOR messages, and talk shows featuring KFOR personnel. The content of the messages disseminated to the public included information from NATO, the U.S. State Department, KFOR, and UNMIK. The MEDCAPs and DENCAPs also interacted with the public by visiting remote communities and providing medical services.

The MNB(E) information operations team also created talking points that addressed key KFOR and MNB(E) sector issues and objectives for the information campaign. Typical subjects addressed a wide range of interest areas such as refugee returns, civil registration, mine awareness, role of Kosovo Police Service, and status of UNSCR 1244. These talking points were updated weekly or as required and distributed by FRAGOs to all levels of command. They served to provide a common perspective and educate those involved in the operation so that while on patrol or engaged in discussions with the local populace and community leaders the soldiers were prepared to discuss in some detail

issues and initiatives. Commanders on the ground viewed this as a very effective tool for their use in conducting operations.

PSYOP

Major Jorge Rangel, U.S. Army, commanded the 315th U.S. Army Reserve PSYOP company. The PSYOP company consisted of a tactical PSYOP detachment with three tactical PSYOP teams (TPT) and a product development detachment (PDD), located on Camp Bondsteel. In order to meet MNB(E) force protection requirements, each TPT consisted of four military personnel plus an interpreter. Frequently, combat camera accompanied TPT deployments, and at times, they helped the TPT meet the force protection requirements by providing the additional vehicles and shooters to meet the two-vehicle and four-shooter configuration for deployment into sector. The PSYOP company consisted of assets capable of disseminating operationally relevant information and associated messages to support the brigade's mission. However, given they actually supported all of the Multinational Task Force objectives (six battalions and a brigade level QRF), it was felt that six teams would have been more appropriate. Some believed the TPTs would have best served the task force if they were stationed with the maneuver battalions around the sector. However, the task force leadership wanted to keep this asset centrally located and controlled.

Although PSYOP used the PDD to develop and produce their own products, they did some local contracting for publishing as well. The tactical PSYOP company did not train for Presidential Decision Directives (PDD) operations or deploy with professional journalist and radio/television broadcasters and technicians as part of the team. The PDD staff stepped up to the challenge and under the circumstances did an outstanding job supporting the brigade. The arrival of 1st AD Mobile Public Affairs detachment in June included a broadcast media specialist who was able to provide professional support to PSYOP. By mid tour, the PDD made the greatest contribution to the over all PSYOP effort because of its good relationships with television and radio stations in the region. The impact of their contribution was largely due to the technical sophistication of the target audience and their willingness to engage the mass media.

The PSYOP team provided the ability to reliably and quickly access and influence the behavior of the target audience in MNB(E) using print media, radio, television, and face-to-face dissemination. The PDD could generate print products in 12 hours or less once approved. Radio scripts could be done in less than 2 hours. Getting product approval for dissemination could take up to 12 days. The process involved review by the G3, information operations cell, Staff Judge Advocate, political advertising (POLAD), and any other applicable staff section with final approval requiring sign off by the Chief of Staff, battalion commanders, and the task force commander.

Although the PDD had its own translators, one of the other big challenges was timely and accurate translation into Albanian and Serbian. CAT I personnel (local hires) often lacked basic translation skills and CAT II personnel (U.S. secret-cleared) with Serbian language skills were hard to come by. It was important to have translators that could accurately comprehend, speak, and write the language.

The purpose of TPTs was to provide ground-truth passive intelligence, establish UNMIK and KFOR credibility, foster cooperation between the Albanians and Serbs, help stabilize the region, eliminate violence, and promote ethnic tolerance. PSYOP personnel conducted engagements directed by the MNB(E) targeting process. All PSYOP soldiers were fully briefed and understood UNSCR 1244, the Task Force Falcon commander's intent, and commander KFOR's intent. This allowed every PSYOP soldier to speak intelligently with civilians about the purpose and intentions of UNMIK and KFOR. PSYOP team leaders spoke directly with community leaders, NGOs, and U.N. organization personnel. This offered them an opportunity to develop a sense of ground-truth and to assess the effects of MNB(E) operations. Senior staff read the TPT situation reports because of the consistent value of the (passively) obtained information.

The battle rhythm was demanding. The TPTs deployed into sector 6 days a week and at times on Sunday as well. In addition to supporting QRFs, TPTs were also used to support special events, such as the 1-year anniversary of the liberation of Kosovo. Many of these occurred on Sundays. They also supported cordon and search missions where weapons were confiscated. In these cases, the TPTs deployed with loudspeakers in order to help the maneuver battalion with crowd control should a disturbance occur. The PDD staff of seven supported 17 to 19

live radio shows per week and 1 to 2 television shows. These activities presented a variety of guests and topics all aimed at maintaining support for KFOR and NATO forces at work in the region. In addition, the PDD developed 5 to 7 print documents weekly and a newsletter, the *K-FORUM*. PSYOP participated in the daily BUBs and held staff meetings Monday through Saturday. They participated in the task force targeting meetings and information operations working groups, including representing MNB(E) at the weekly KFOR-sponsored PSYOP working group. MNB(E) PSYOP team also launched a cross training exchange with the German, UK (referred to as Shadow Element) and French PSYOP elements. In September, PSYOP conducted a media conference in which local Serbian and Albanian media providers came to Camp Bondsteel to discuss relevant media issues. Because of this effort, an Albanian station agreed to fax daily news bulletins to a Serbian station. All participants agreed that future conferences would be beneficial. PSYOP personnel also provided the TFF ACE through daily situation reports relevant information (passive intelligence) on topics and issues germane to the MNB(E) mission.

PSYOP fliers were distributed to the public as different needs or events arose. For example, fliers explained to the residents of Strpce that a recent attack on the UNMIK office was an attack against KFOR and would result in sanctions against the community. Fliers announced curfews, explained KFOR actions, and promoted community-building initiatives. Using a Risograph, the PDD produced handbills such as the *K-FORUM*, a one page, front and back newsletter. The news articles were not generally written by the PDD staff, but from open sources. The *K-FORUM* was produced in Albanian, Serbian, and English. Since many the small towns did not have access to news media other than radio and television broadcasts from Serbia, the *K-FORUM* gave them the news of Kosovo. While in sector with a TPT, one of the major points made by the residents of the small village visited was the desire to get access to reading material. They were quite pleased to receive the handouts from the TPT, which also included the *Dialogue*, the KFOR magazine produced in Pristina. For a while, excess *Stars and Stripes* newspapers were distributed throughout the sector.

The MNB(E) PAO published *Falcon Flier* was also given to locals when it was available. Posters addressed a variety of issues, such as reporting crime, the KFOR and local veterinarian program to capture stray dogs, and mine awareness. KFOR placed ads in newspapers such

as the Albanian *Fer Press* in Urosevac. One such ad called for an end to violence and contained a picture (taken by combat camera in the operating room of the MASH hospital on Camp Bondsteel) of an 8-year-old girl who had been shot (Figure 3). Over time, the *Fer Press* proved unpopular with the public and MNB(E) ceased to use it.



Figure 3. PSYOP Product for *Fer Press*



Figure 4. Thumbs Up for KFOR

Along with presence patrols conducted by the maneuver battalions, face-to-face PSYOP was a significant operational capability. The three MNB(E) TPTs were used to provide coverage throughout the brigade sectors including the areas controlled by the Russians, Poles and Greeks. The TPTs distributed PSYOP products, conducted loudspeaker operations, and held face-to-face sessions with the public. Loudspeakers were used for crowd control as well as information campaigns. For example, the “Thumbs up for KFOR” (Figure 4) information campaign that was aimed at trying to stop children from coming up to KFOR vehicles and trying to give or receive a high five from the soldiers. There were some that felt the campaign also aimed at countering the use of the three-finger VJ victory sign by the Serbian children. TPT personnel were trained for personal contact with the public, and were effective in persuading and influencing public perceptions of KFOR. They were also able to assess the immediate effects of their engagements and detect changes in behaviors and attitudes in later visits to the communities.

While face-to-face communication with the locals was the most effective means of PSYOP, television and radio were the best ways to communicate with the majority of the population. Face-to-face is a precision, high impact method of administering the message of the commander. Radio and television allowed PSYOP to convey the commander’s message more effectively to the mass of the population, thereby promoting support for KFOR on a wider scale.

In addition to producing and disseminating fliers, handbills, posters, and other print products, the PSYOP company was capable of producing radio and television programming. Local radio stations were contracted to broadcast MNB(E) information and messages (Figure 5). There were two Serbian radio stations, Radio Max in Silovo and Radio Zupa in Brezovica. I was able to visit Radio Max one evening with Staff Sergeant McCarthy. Radio Max was a husband and wife run radio station located in their home, which was under construction in a Serbian enclave. PSYOP paid for airtime and provided the station with CDs, KFOR announcements, and scripts.



Figure 5. PSYOP Sponsored Radio Station

There were seven Albanian stations under contract: Radio Festina in Urosevac, Radio Victoria in Gnjilane, Radio Iliria in Vitina, Radio TEMA in Urosevac, Radio Energji in Gnjilane, Radio Pozaranje in Pozaranje, and Radio Kacanik in Kacanik. UNMIK ran a joint Albanian/ Serbian radio station in Kamenica. I was able to visit this station, which was located in the UNMIK building. To my surprise, there were two collocated sound booths, one Serbian and one Albanian, for the broadcasters. A glass partition separated them (Figure 6). The terrain and cost were too restrictive to initially set up full AOR radio coverage, so several small stations were used to achieve limited coverage to get things started. The number of contracted radio stations grew from 6 regional stations in April 2000 to 14 by the end of July with coverage that extended to all 7 municipalities across the brigade's sector. As the number of stations grew, the PSYOP company took advantage of the opportunities to expand broadcast coverage for dissemination of information and messages to support the MNB(E) mission.



Figure 6. Combined Serbian and Albanian Radio Broadcast Booths

The first operational Kosovar television station in sector, an Albanian station television Vali in Gnjilane, did a couple of KFOR broadcasts in May but did not reemerge until July 2000. Given the new television capability, the PSYOP Company was preparing to initiate a similar vigorous effort with television broadcasting as they did with radio. The most popular program was the live Four Pillars show, which featured the local KFOR commander and representatives from UNMIK, UNMIK police, UNHCR, and OSCE. These shows were normally scheduled for 1 hour, but often went on for 2 to 3 hours and in many cases had to be cut off after several hours of broadcasting. The shows were successful because authoritative principles from important organizations were present and questions on most any subject were answered with credibility.

In addition to producing radio public service announcements, the PSYOP company scheduled and prepared MNB(E) headquarters personnel for appearance on live radio shows. The PSYOP company and the information operations cell coordinated each week on topics, facts, and messages appropriate for public service announcements and radio shows. Meetings were held after shows in which call-in questions were received from the local populace in order to ensure follow-up facts and messages were addressed in later appearances. By July 2000, each task

force maneuver battalion commander had a contracted radio station available in his sector to conduct weekly live radio shows.

At the time of the departure of the 315th, they were doing 17 to 19 live radio shows per week and 1 or 2 television shows. These shows covered a wide range of topics and important KFOR communicators:

- Commanders, soldier shows, and information operations;
- Medical, dental, veterinarian, and pre-natal care;
- Preventative medicine, substance abuse, and nutrition;
- NGOs and UNMIK four pillars;
- Psychological trauma;
- Rule of law, legal issues in the region, and finance;
- English;
- Farming;
- U.S. History and education;
- Weekly operations updates; and
- Children's stories.

Translating and interpreting live on the air was dangerous because hasty translations would leave room for error when accuracy was of highest importance. There were plans to get some broadcast delay equipment to support live call-in radio talk shows.

The weekly MNB(E) information operations working group provided a good source of feedback from those in the field who were able to sense local population sensitivities and changes and views of the products disseminated. Face-to-face interactions with leaders and local residents and building trust relationships with these people provided a means to get honest feedback. The KFOR information operations and PSYOP working groups were good forums for obtaining feedback. Open source literature was reviewed and radio shows and other media were monitored. There was a weekly coordination meeting with OSCE who

had an extensive media monitoring activity. Behavior change takes time and some changes would not become evident immediately.



Figure 7. KFOR Headquarters

While in Prizren for a KFOR-sponsored information operations working group, I met LTC Grade, German military. As the chief of the KFOR PSYOP support element, he was in Prizren to chair the KFOR-sponsored PSYOP working group. In response to an invitation to visit KFOR headquarters to discuss KFOR PSYOP activities, a trip was made to Film City, the home of KFOR headquarters. Film City was a film studio (Figure 7) located on a hill overlooking the city of Pristina. There were some first impressions of KFOR headquarters that served as a reminder that contrasts in Kosovo also exist within the KFOR military establishments. After having spent several weeks at Camp Bondsteel and deploying into sector multiple times with U.S. forces, a few things struck me as being different as I arrived at KFOR headquarters. As I entered the main gate, I saw a street lined on both sides with national PXs that sold anything from alcohol to souvenirs. Second, soldiers were not wearing helmets, flack vests, or carrying weapons. In fact, some of the multinational military uniforms were shorts, not battle dress uniforms (BDUs). Third, although there was certainly heavy force protection around the base perimeter, soldiers were free to walk on and off the base subject to having appropriate identification. Soldiers were also free to eat and drink at local establishments and buy from vendors on the streets, in shops and outside the main gate to KFOR. The pace

of KFOR headquarters operations was busy but certainly less hectic than MNB(E) headquarters activities. It was almost like being on a base in Germany, a stark contrast to MNB(E)'s high OPTEMPO and strict force protection.

The KFOR PSYOP support element (PSE) reported to the chief of the Information Campaign (IC), who in turn reported to the KFOR assistant chief of staff for operations. The PSE was generally focused on the Pristina area, rather than all of Kosovo. This lack of comprehensive focus led to the MNBs being vastly different in their approaches to PSYOP. NATO funding was not sufficient to have the PSE assume a leading role in the information campaign. Reporting to the IC chief was an IO coordination section who were responsible for long-range planning and current operations. France, Spain, and the UK did not participate in the PSE. Germany, Denmark, Belgium, Italy, U.S., and Romania were the contributing nations. The PSE operated the KFOR owned print, radio, and television assets and coordinated the theater-wide PSYOP campaign with the MNBs. The primary means of coordination was the weekly KFOR sponsored PSYOP working group that rotated its meetings between KFOR headquarters and the headquarters of the MNBs.

KFOR taped radio programs and monitored their quality to be sure that the script sent was used and that local stations did not use them out of context. The products were written in English first and then translated. UNMIK, OSCE, and the MNBs conducted media monitoring and KFOR tried not to overreact to propaganda. KFOR was truthful and distributed pragmatic information. The general rule was, "do not react to disinformation, react to selective issues of importance."

There were plans to expand the KFOR PSE from a small, largely military team to a staff of 53 that included civilians as well as military. In order to improve the effectiveness of the operation they needed better continuity, given the high turnover rate of the KFOR military personnel. In addition, they needed to build a professional journalist and radio/television production staff for the longer term. The military would cover 32 positions and 21 would be a local civilian mix of Serbs and Albanians. There would be 12 staff covering radio, 2 for television, and the rest would cover the print media. The PSE had four interpreters and could use the KFOR command group interpreters as well. The military staff would rotate and civilian staff would provide the continuity.

Some Observations

Assessment of information operations effectiveness was extremely difficult. Attempts to do so were highly subjective and dependent upon interpretation. Every 3 months, Gallop conducted a survey of Pristina and Metrovica, which estimated the number people that saw and used the KFOR products. OSCE provided daily and weekly reports on radio, television, and print media activities. All units who interacted with the public also contributed their insights and observations from the field.

There were a number of early KFOR PSE issues to be addressed. The experience, education and training of the military staff assigned to the PSE varied and generally did not adequately cover unique aspects of the operation, such as culture, religion, and politics. The MNBs saw themselves as independent and there was a need to better integrate and leverage KFOR and cross-MNB PSYOP activities. The assets and experience of the MNBs were quite different as well. Two had good access to radio and television and some had none. Radio and print experts were needed to compete with local media. KFOR and the MNBs needed professional journalists and broadcasters. The initial information operations and PSYOP capabilities at KFOR lacked the expertise that KFOR was trying to develop. KFOR had an excellent relationship with Radio Television Kosovo (RTK). They relied on the local RTK television expertise, since this was something their own their staff lacked. In order to develop a capability, KFOR established a training program with RTK to educate their television staff. They were using internships to train their staff. KFOR had good relationships with the local radio stations as well. CJ2 screened civilian candidates recommended by UNMIK, RTK and others for the PSE openings. Candidates needed to provide documentation on personal background, expertise, and demonstrate certain skills.

Other challenges included the Serbian Red Cross, which was essentially funded and controlled by the Serbs. It was reported that they were taking USAID and other international aid packages and covering the source markings with Serbian Red Cross markings before distributing to the Kosovar Serb community. Russian soldiers in Kamenica region were reported to be displaying the three-finger VJ victory sign to the local Albanian population. It did not serve to improve their image, and further created tensions between Albanians and Serbs, especially when

the children started returning the symbol to the Russians and other KFOR forces. Joint U.S. and Russian patrols were conducted to portray unity of effort and an MNB(E) information center was opened in Kamenica, these combined efforts served to enhance the acceptance of the Russian forces in the area.

CHAPTER XXIII

Public Affairs

Larry Wentz

New ways of military thinking about the media have begun to emerge. For example, the term *media awareness* is now used by the military, implying that the old ways of thinking, such as “keep the press under control,” are going away. The media today enjoy greater access to soldiers supporting peace operations than in any other military operation. This is not true, however, for combat operations. For the air war over Serbia, General Clark, U.S. Army and SACEUR, placed tight controls on media relations and the release of information on allied air operations.

Peace operations can be just as complex as combat and the media coverage involves more than simply reporting on the military operation. This means that in addition to being familiar with the military, the media also needs to have a working knowledge of the humanitarian, political, economic, cultural, social, legal, and even criminal justice issues of the country in which the peace operation is being conducted. Furthermore, today’s journalists and broadcasters often have communications capabilities that are superior to those of most other actors on the peace operations landscape, including in some cases even the military. Coupling the superior communications capability with privately contracted transportation assets means that journalists, once dependent on military forces for logistic and communications support, are now largely independent agents—many times arriving before the first military response to a peace support operation.

The changing reporting and operating environment affords a number of the media the ability to file real-time or near-real-time news from the field. Using satellites, cellular telephones, and computers, the reporters can file their stories and provide simultaneous reports of activities occurring throughout the peace support operation environment. As a result, the media can flatten the traditional organizational hierarchy through unrestricted access and compress decisionmaking cycles

through real-time reporting. Indeed, the speed with which media file their stories is faster than the transmission of information up a military chain of command or through an aid organization to its leadership. Around-the-clock news reporting has created a seemingly insatiable hunger for newsworthy stories. The access, filing capabilities, and pervasiveness of the modern media corps virtually guarantees reporters will transmit all newsworthy events in real-time to a global audience. Therefore, the military needs an effective media policy and a comprehensive strategy and information plan that is part of the overall peace support operation planning process and addresses how the military forces should interact with the media in peace operations.

Multinational peace support operations have high global visibility, but media and public interest in such events is relatively short lived. The conflict in Kosovo was such a case in 1999. There was heavy daily coverage of the air war and Task Force Hawk—its Apache attack helicopter deployment had heavy coverage since the press anticipated possible combat operations. In spite of the difficulty of physically getting to the Kosovar refugee camp (Camp Hope), the Joint Task Force (JTF) Shining Hope humanitarian assistance operation received media coverage up until it was turned over to the UNHCR on June 26, 1999. For the KFOR deployment, it was reported that a staggering 2700 media people accompanied the NATO forces when they entered Kosovo at the end of the bombing (at the peak of the Vietnam War there were 500 correspondents).

The establishment of an effective media policy at the outset of the KFOR operation was important to its overall success. There were differences in media policy among major NATO elements such as SHAPE, AFSOUTH, ARRC, and KFOR. Furthermore, there were differences between NATO and the troop committing nations and their national policies and actions. As a result, the overall media policy for the Kosovo operation was unclear and coordination of related NATO and national activities was problematic at times—NATO and the nations did not always speak with one voice. There was a lack of tactical communications supporting the public affairs (public information) activities and this was particularly true for MNB(E). The communications capabilities of KFOR and the MNB public information elements lacked compatibility and connectivity. There was little coordination among the public information activities during the early phases of the KFOR deployment and even after a year, coordination was still an issue being

worked by the KFOR public information officer with his MNB counterparts. The Internet was an important medium for promoting the image of the operation and KFOR access to the Internet was a problem at the outset of the operation, but it improved significantly over time with the establishment of the KFOR unclassified WAN and the KFOR Web site. The MNBs also had Web sites supporting activities in their sectors and these sites were linked to the KFOR and appropriate national sites as well as UNMIK, OSCE, EU, and NGOs. E-mail was found to be an effective means to communicate with the international media and provided KFOR and the MNBs an ability to surf the Internet to obtain the international media views of the operation.

KFOR tried to have its public information centers located outside of the military bases, usually in a hotel or commercial or government office building, in order to ensure open access but also to avoid unauthorized media access to the military operational areas. Although the objective was to make press access to the military as easy as possible, not all press information centers offered unrestricted access to the media. For example, the German and U.S. press centers were located on military guarded and access controlled base camps, limiting the freedom of access whereas KFOR and the other MNBs had theirs outside. The KFOR press center was in a commercial office building in downtown Pristina with open access to the media. The MNB(N) French run press center was located in an old Serbian military hotel in Metrovica with a military guard at the entrance but the accredited press had free access. Putting the public information center outside the wire did require some military security measures to ensure the safety of the journalist should an attack occur.

The local and international media coverage of the KFOR deployment was generally favorable, however, few international media remained several months after the extensive coverage of the initial deployment and stabilization activities and herein lies a major difference between war and peace support operations. For war coverage, the stories end when the troops go home but for peace support operations, the stories end when the media goes home. Hence, the military Public Affairs Officer (PAO) or Public Information Officer (PIO) has a much more challenging job in the long haul to keep the media interested in telling the soldiers' stories and reporting the successes of the operation. There are other differences that affected military-media relationships. In wartime, the military (for operational security reasons) imposes

restrictions on the release of information, limits press access to the military, and controls coverage in the war zone by using staged briefings, press pools, and military escort officers. In peace operations, the media live and operate outside the military as independents with the freedom to travel and work at their own discretion. In many cases, they were generally better informed on local developments than the military intelligence operations.

When a newsworthy event makes the headlines and the evening news, the world public, the families of service members, the news media, and even governments have an insatiable appetite for information that must be made readily and immediately available. Many of the old sources of controversy such as censorship, access to military units, press pools, and transmission of information back home are no longer at the center of discussion of military-media relationships for peace operations. CNN is everywhere on the peace operations landscape and where they go all other media will follow. Censorship today is virtually impossible, especially with today's communications and information systems capabilities that allow the media to virtually broadcast live from essentially anywhere in the world at any time. Cellular phones offer instant uncensored connectivity to those on the ground and the global Internet's e-mail messaging and Web sites offer uncensored information from persons who are both on the inside and outside of an operation. Globalization of information has significantly changed the way people follow and report on military operations.

The importance of good media relations is reflected in an observation made by COL G. Anderson, USMC. He said, "The media gives you a chance to tell your story. You never get a second chance to create a first impression." Another important observation by Dr. Lawrence Yates of the U.S. Army Command and General Staff College is also worth considering. "The news media commands the public's perceptions of the military. The most productive response to the presence of the media is to be honest and to assist the journalists in disseminating information."

There have been moves by the military to become more media friendly, requiring new field manuals and media awareness training for commanders and soldiers. A bold and innovative plan in Army military-media relationships surfaced in Bosnia with the use of embedded media, an approach used successfully by the Marines since WWII. Journalists were assigned to Army units to be deployed to Bosnia and accompanied them when they deployed. The rationale was to foster familiarity on the

part of the journalist with the unit and its soldiers. The assumption was that as the reporters got to know the unit and the soldiers, they would develop a more positive attitude toward the military mission and tell their story. It was also believed that the immediate presence of reporters would foster a more positive attitude on the part of the soldiers toward the media. The downside, from the military's point of view, was that commanders might become too comfortable with reporters thereby making candid remarks that might embarrass the Armed Forces.

U.S. forces deploying into Kosovo used the embedded media concept as well. There were some 30 reporters that entered Kosovo with U.S. troops from Macedonia and stayed 1 to 2 weeks with the units they accompanied—both the PAOs and journalists felt the embedded concept worked well. The military intent was to continue to ensure a free flow of information through a close working relationship with the media and to make press access to the military as easy as possible. Press conferences, media opportunities, scheduled interviews, information handouts, and escorted visits to outposts were organized and used by the PAO as a means to keep the media informed of MNB(E) activities and to keep the information flowing. For example, while I was in Kosovo, the press was invited to attend the TOA between 1st ID and 1st AD held on the parade ground on Camp Bondsteel. MTV news host Serena Altschul and three television producers arrived at Camp Bondsteel to film a documentary about the lives of young U.S. soldiers during a peacekeeping mission. Escorted visits to outposts such as Sapper and deployed units were conducted as well. The *Stars and Stripes* reporters were seen frequently on Camp Bondsteel.

DoD policy encourages cooperative military-media relationships and a culture change is taking place on the part of the military and media, but building mutual trust takes time. There was a feeling on the part of a number of people interviewed that the Army was still somewhat at arm's length when dealing with the media. For example, while accompanying a military-escorted group of correspondents to outpost Sapper, I asked Jennifer Black, the *World News* correspondent, for her impression of working with the military. She said she felt from her personal experiences that the U.S. forces (mainly the Army) kept the media at arm's length, whereas other militaries did not. When KFOR deployed, she accompanied the British into Kosovo and had a good working relationship with them while in their sector.



Figure 1. Correspondents Visiting Sapper

These same correspondents interviewed the PAO (Figure 1) and some of the soldiers manning the checkpoint at Sapper. They also interviewed some locals being searched at the checkpoint. Following the interviews, the journalists decided to walk, without military escort, into the town of Dobersin a few kilometers away in the General Security Zone where the UCPMB had a training area. Jennifer Black walked the rugged dirt road in sandals since her luggage had not made it on her commercial flight to Skopje from London. When the correspondents returned from Dobersin an hour or so later they said they tried to talk to some soldiers at the training area, but were told they did not have time to speak to them since they were busy. The correspondents had also walked into the town of Dobersin but were not very successful in getting anyone there to talk to them either. Although these examples are only a small sample of real world experiences, significant efforts were made by the military to work cooperatively with the media and to share information with them.

U.S. Marine Corps (26th MEU) Public Affairs

Marine Corps Public Affairs serves as a link between Marines and the public. Public Affairs Marines must be trained, equipped, and postured to serve the force commanders, as they execute their duties in keeping Marines and the American people informed of what is happening on

the battlefield, as well as on Marine Corps bases. To accomplish their mission, PA Marines must have a sound understanding of the organization, tactics and equipment used in war and other conflicts. They must be integrated into the commander's battle staff and must train side-by-side with the warfighting units.

Captain Gabrielle Chapin, U.S. Marine Corp, was the public affairs officer during the 26th MEU participation in Operation Allied Force, Task Force Shining Hope, and Operation Joint Guardian. The 26th MEU involvement with the media in Kosovo actually began during operations in Albania. An early USMC PAO assessment of where American and international media were located during the air war and the humanitarian assistance operation indicated that the majority was staying in Tirana, Albania. For the press, it was a somewhat dangerous 4-hour trip by land from Tirana to Camp Hope, the Kosovar refugee camp for which the Marines had provided security. Attacks by bandits were a constant threat along the way—besides cash, the bandits were interested in reporter's satellite phones, cameras, laptops, and four-wheel drive vehicles. In order to more effectively engage the media, the PAO created a sort of round robin operation where media would be flown from Tirana to the U.S.S Kearsarge, remain overnight, and then be taken by helicopter in the morning to Camp Hope and then returned to Tirana. In addition to making it easier and safer to get to Camp Hope, the intent was to provide the media a place to file stories and hold numerous interviews (Colonel Glueck the 26th MEU commander, pilots flying bombing missions, Marines going ashore to provide security at the refugee camps, etc.). The number of journalists was kept to around 20 at a time in order to accommodate their needs. The beauty of the media plan was that there was so much going on that the media were extremely pleased with the access—the Marines were involved in the NATO bombing mission, were on TRAP (tactical recovery of personnel) alert, and were providing security at Camp Hope where refugees were arriving. This was where the good relationships between the 26th MEU and the media were established for the Kosovo operation.

By the time the Marines received word that the 26th MEU would participate as part of the initial U.S. force into Kosovo, they had already worked out who from the media should go in with them. Colonel Glueck supported the idea of embedding media within units, on a space available basis. It is important to note that embedding media is something that has traditionally made the Marine Corps famous—for

example, the photos taken by Louis Lowery and Joe Rosenthal of the Marines raising the flag at Mt Suribachi in WWII.

Days before disembarking at the Thessaloniki, Greece landing site, the journalists selected were flown to the ship and introduced to their units. Units were selected based on their place within the convoy. For example, reporters and journalists were assigned with units that would best suit their needs. One television crew traveled in the back of a five-ton truck and filmed the convoy as it traveled up the winding roads from Thessaloniki to the staging area at Brazda, Macedonia and then on to Gnjilane, Kosovo. Colonel Glueck allowed one TV satellite truck to be placed into the convoy. The TV satellite truck provided each of the networks an opportunity to cover events as they happened. Ground rules were established for the release of information. The media only stayed with the units for a few days after arriving in Kosovo. Requests to remain with the units could be made with the PAO once in country. On the day of the launch, the journalists mustered with their units as though they were members. CNN set up a live remote near the landing craft air cushion (LCAC) vehicles and the world was able to follow the 26th MEU amphibious landing in Greece and departure by road convoy for Kosovo. However, this was not the end of the media coordination. Colonel Glueck also allowed those who could not be accommodated for the deployment to be on the beach where the landing would take place. A public affairs rep was at the landing site the day before and established an area for media to meet. Those accredited were allowed closer access and opportunities to interview Marines and commanders.

The movement over the border into Kosovo was not fluid. Units were held up at the border for some time. Still, those media with units were fed and bedded down with the Marines. The embedding process was important because it gave the media a deeper (and often more appreciative) understanding of how Marines live and work. Because there was only one public affairs officer for the 26th MEU, a system of handling the overwhelming number of journalists already in country needed to be established. The plan was to inform all major news services that each day the 26th MEU would offer a situation update in the morning and then allowed opportunities to go out on patrol with some of the mechanized units. Others were shown where units were located within the sector. The key to handling the large number of journalists interested in covering the operation was to provide media-relations training for each member of the 26th MEU prior to its deployment.

Media training for the Marines began early in the work-ups and included a number of classroom type discussions and on camera interview sessions. Each small unit leader was aware of what tags media must wear to prove accreditation, ground rules for media embedding or visiting units, and the importance of allowing them open access on a not-to-interfere basis. For example, if one of the news networks happened to stumble upon a Marine checkpoint and wished to spend the night, a call was made to the PAO for confirmation. The PAO attempted to track where major media were located within the Marines sector. By embedding media, each unit became comfortable having them present. This positive relationship between the 26th MEU and media resulted in very positive coverage.

Media operations supporting the initial KFOR deployment were essentially independent even within the Task Force Falcon piece of the operation. The Marines setup their media operations in a field overlooking Gnjilane. Because there were limited communications capabilities at this stage of the operation, there was little to no contact with other PAOs. A Joint Information Bureau was not established at the outset. Communications and information systems supporting PAO were sparse. This was largely attributed to PAO not being a high priority for acquisition and modernization. On the other hand, the media with their state of the art satellite phones, cellular phones, mobile TV capabilities, and laptops were well equipped to receive and send information in an environment such as Kosovo. The Marines JTF Enabler communications package was available for use by the media to file stories/photos once they arrived in country. However, it was more likely that the military might need to use the media equipment. In fact, the Marines used the media satellite phones on a number of occasions during the deployment operations.

The 26th MEU was able to accommodate up to 300 journalists a day because the Marines were well trained in dealing with the press. Each acted as a spokesman for the MEU. The 26th MEU established relationships early on, had a good system of ground rules, and provided very open access. The media did not interfere with the operation. Instead, they were an integral part of the operational environment. There was no spin when dealing with the media. Colonel Glueck made himself available to media and answered questions in a direct, accurate way. Finally, besides accommodating media, a number of young Marines sent photos and stories through the U.S. Navy Chief of Information to AP, Reuters, and all major news networks. This offered yet another

opportunity to tell the Marine Corps story. For example, one of the Marines had taken a photograph of a firefight, and it appeared on the front page of Washington Post and New York Times the morning following the event. The PAO also created a Web site on the 26th MEU homepage to share information on the operation.

Task Force Falcon (U.S. Army) Public Affairs

The mission of the U.S. Army Reserve Mobile Public Affairs Detachment (MPAD) attached to the MNB(E) was to ensure free flow of information throughout the operation to external media and internal audiences to convey the Army experience. The Public Affairs team consisted of 18 soldiers who were print and broadcast journalists. As Sergeant Jack Eden, U.S. Army Reserve, put it, "I'm a photographer with a pencil. We tell stories both in pictures and words."

The MPAD had two aspects to its operation: the command support side and the public affairs side. They advised the commander and served as his spokesperson for releasing information on operations. The MPAD coordinated and facilitated media operations and produced unit internal information products. Major Debra Allen, U.S. Army Reserve, was the commander of the MPAD and also functioned as the Brigade Public Affairs Officer. The public affairs operations included press releases, media escorts, and interviews with MNB(E) leaders. They participated in the TFF Crisis Action Cell and integrated operations with the MNB(E) information operations efforts. The PAO needed to be able to make public disclosures of significant events with a minimum of delay. PA also provided G5-like task force command information coverage, such as base photographers. They monitored external media coverage but they could not reproduce and hand out copyright material (PSYOP and open source intelligence [OSINT] activities could do this).

In practice, the G3 battle captain alerts PA and other headquarters support elements such as PSYOP and combat camera of significant events for which coverage was appropriate. The PAO felt that there was a G3 problem in this regard since frequently the PAO was not alerted to cover significant events. While I was at Camp Bondsteel, I did observe a situation that should have had PA involvement but did not. A QRF was activated one evening to cover a rock-throwing incident in Kamenica. PSYOP and combat camera were called up to accompany the QRF but PA was not. The reason for this was unclear at the time but

upon reflection, a contributing factor to an apparent PAO-G3 disconnect may have been one of mode of operation of the MPAD and the PAO. Involvement needs to be a proactive two-way process and as such, both the G3 and PAO need to actively engage each other and this did not appear to be happening on either part. Up until June 2000, the MPAD media operations seemed to be more reactive than proactive in its interactions with elements of the task force. They produced press releases when directed by the MNB(E) leadership, escorted media representatives when notified, and tended to take a generally neutral stand when providing information to the media that entailed releasing only facts with no associated messages. The MPAD rotated in July 2000 and with the change in unit came a more proactive approach to media operations. The new MPAD initiated press releases to ensure the facts surrounding events that could impact the MNB(E) mission were released as quickly as possible to head off potential misinformation or propaganda. The MPAD coordinated with the information operations section to ensure that appropriate MNB(E) messages were released. The MPAD also coordinated with the information operations section on facts and messages to use in preparing senior MNB(E) leaders for press interviews and speeches.

The MPAD coordinated media coverage for all units in Task Force Falcon. In addition to the Camp Bondsteel operation, there were two journalists at Camp Montieth supporting the maneuver brigades and a TFF PA liaison officer located in Pristina at the KFOR Press and Information Center who worked with the media and the KFOR Public Information Office. The TFF PAO served as KFOR spokesperson in Gnjilane when KFOR PIO could not attend the weekly press conference. There was a difference in the pace of PA activities at Camps Montieth and Bondsteel. Montieth was much more active pace—they were closer to the sector action. It was suggested that Bondsteel was too spread out and this made it harder to find out where the stories were. The maneuver brigades liked to have PA come along with them to give visibility to their units and soldiers. The PA photographers and journalists went out with CA and PSYOP teams and covered significant operations (MEDCAPS and cordon and search operations). They covered hospital stories about the medical staff and victims. On visits into sector, the PA journalists were genuinely impressed by the gratitude from the Albanians for the U.S. being there to help, especially during the winter.

Unlike Bosnia, the TFF PAO did not have direct access to DoD PAO; they used the chain of command to send information unless it was a very special event requiring direct access. Normally, TFF PA reported to USAREUR PAO who reported to EUCOM PAO. Once a week a conference call was held with the U.S. PAO at SHAPE headquarters. OSCE/UNMIK held a press conference every Wednesday in MNB(E): one in Gnjilane covered by U.S. TF 1-63 Armor out of Camp Montieth and one in Urosevac covered by Greek units.

The MPAD worked with radio stations and did special interest and significant event videos. They had a video shelter with professional production equipment that could be used to produce commercial quality videos. Combat camera also used pictures and video to document events and activities for historical purposes and other special uses. Although they used professional photographic equipment, their production capability was of a lesser quality than the PA capabilities. The MPAD produced family support videos that were sent back to Germany. Scripts and commercial quality videos were provided to AFN radio news and AFN/USAREUR TV news as well.

DoD funded media visits for small town journalists who would not normally be able to make such a visit. There was a hometown news release program for newspapers. However, doctrinally and legally, PA could not target the public and decisionmaking community. They did not survey hometown newspapers to see where it might be appropriate to provide soldier stories. If asked, they would provide stories. The PA office facilitated coverage of the TFF by the local and international media. They invited and coordinated media coverage of special events. There was a Media Operations Center on Camp Bondsteel with briefing rooms and related visual aides and support capabilities. There was also a small media center at Camp Montieth. PA coordinated and facilitated media escorts into the sector and in their view, it was better to have PA accompany the media than to have the journalists show up unannounced and conduct interviews on their own. For significant events, the PA staff did a worst-case assessment of questions they and the commander were likely to be asked and crafted appropriate responses.

Support was provided to the information operations cell and PSYOP but there was concern about maintaining their objectivity and independence while still being a team player. A key concept of the PA information policy was to be transparent, rely on the truth and dispatch

complete, accurate and timely information to establish the task force and the PAO as a credible source of information and to gain and maintain public trust for KFOR and MNB(E) operations. Therefore, support was in the form of attending and participating in the TFF meetings (the MNB(E) information campaign was fundamentally truth projection aimed at helping gain international support). Since PSYOP did not deploy with its full complement of production capabilities, the MPAD did help do some specialized work for them. They contributed radio scripts and print stories and helped with some products in support of special events such as the Clergy for Peace Conference held on Camp Bondsteel.

KFOR PIO provided guidance for a wide range of subject areas such as mine awareness and clearing actions, special events, and cordon and search. There was an MPAD reference book kept on file that was used to structure media releases—it contained KFOR, TFF, and U.S. guidance on a range of subject areas. In response to the establishment of a TFF Crisis Action Cell (CAC) in the Tactical Operations Center to monitor and manage an unfolding crisis, the MPAD would put someone in the CAC area to take notes—there was a generic format for producing an initial public release for a special event. They provided print and video coverage of significant events. Many times PA found that the initial information provided to them for significant events needed to be updated before issuing a public release. The approval process for PA products consisted of using the G3 for facts, G2 for security, and chief of staff for final approval. Figure 2 is a sample TFF PA press release.



Figure 2. Sample Task Force Falcon Public Affairs Press Release

Force protection measures were viewed as an impediment to MPAD operations. Missions off base required the presence of four shooters and two vehicles. There was a shortage of vehicles for use by CA and shooters to accompany the MPAD journalists, and this impacted their ability to effectively respond to events, especially for short notice requests for coverage. For example, when I accompanied PA on a pre-planned trip to Metrovica we were delayed for over an hour trying to round up two shooters to accompany the group. The MPAD journalists felt their ability to freely move around sector was being hampered by the rules. There was also a photography-related force protection issue stemming from the fact that there was no official policy for on-base photography. Unofficially, we were told not to take pictures of the base camp gate access areas and panoramic views of remote outposts that showed military positions. The military was outraged when aerial photos of Camp Montieth appeared in the PA published Task Force Falcon newsletter, *Falcon Flier*. Aerial shots of Camp Bondsteel were published later but in this case, the gate areas were blurred. The Serbian newspaper even published aerial pictures of Camp Bondsteel. Since there was no

specific guidance on photography on base, one needed to be careful because cameras and film could be confiscated if inappropriate or compromising pictures were being taken. While accompanying civil affairs and combat camera teams, I was twice challenged about taking photographs on Camp Montieth.

There were other MPAD-related challenges for which at least one had a lasting negative impact on the military journalists I spoke with. This particular issue related to PA coverage of a riot in April 2000 in the Serbian enclave of Sevice. Heavily outnumbered American infantry, MPs, and Polish paratroopers fought and prevailed over coordinated assaults by a Serbian mob that attacked them with rocks and clubs. The PA story on the Sevice riots was not published in the *Falcon Flier*, even though the story had already made the *Stars and Stripes*. In spite of BG Sanchez's strong warning to the UNMIK administrator in Sevice that he would not tolerate his soldiers being attacked, the story was apparently withheld because the task force leadership did not want to risk further upsetting the Serbs. The PA journalists were displeased about this action since they viewed themselves as responsible for publishing the soldiers' side of the story. The decision to not publish the story was demoralizing for them. For the rest of the tour, they were more cautious about what they wrote.

KFOR Public Information

The KFOR Coalition Press Information Center was located in downtown Pristina next to the sports stadium. Each of the MNBs had public affairs LNOs at the CPIC. The CPIC was used for press briefings and as an information center that distributed KFOR and MNB information, as well as publications from UNMIK, UNHCR, OSCE, the World Health Organization, and others on activities related to their organizations. UNMIK, UNHCR, OSCE and EU also had their own public information operations. KFOR PIO held daily briefings in Pristina at 11:30 a.m. Because of the time difference between Kosovo and the continental U.S., this was too early for U.S. media to consider broadcasting live coverage. During the air war over Serbia, the NATO daily press briefings were conducted at 3 p.m., and this gave the event maximum global TV viewing time coverage.

KFOR PIO held an MNB PIO/PAO coordination meeting about once a month. The location would rotate among the KFOR and MNB

headquarters locations. The purpose of the coordination meeting was to provide an update of KFOR and MNB activities and to have discussions of cross-MNB issues related to PIO/PAO activities. The PAOs also shared information among themselves on journalist activities in their areas.

While in Kosovo, I attended the June 2000 KFOR PIO workshop held at MNB(N) headquarters in Metrovica. The KFOR PIO chief was a French LTC and he chaired the working group meeting that was held in the conference room of the French CIMIC Center—Maison de France. The main issue discussed at this meeting was coordination among and between KFOR and the MNBs and the need to improve. The chairman cited the case of a recent MNB(C) weapons cache find and the linking of the weapons to the former UCK—documents, videos, and pictures were found that provided evidence of the linkage. He commented that most of the nations did not put out supporting stories when KFOR made the linkage announcement. It was noted, however, by MNB(C) that the situation did create a lot of KFOR tourism—military from all sectors came by to have their pictures taken in front of the cave where the weapons were found and a Russian contingent even showed up unannounced by chopper one day. The chairman emphasized the importance of KFOR versus national views. He made a strong pitch that KFOR and the MNBs needed to support the Russian contingent, which was constantly being attacked by locals.

Following discussions on the main issues, the chairman then went around the table for selected MNB inputs on activities in their area. A wide range of subjects was covered including upcoming TOAs, registration activities, press activities in their sectors, police activities, and increased occurrences of mine strikes. There was plenty of material to cover. The KFOR Web site had about 130,000 visitors per month and KFOR was in the process of updating and enhancing its Web site. The UK suggested adding MNB press releases and Q&A chat rooms. MNB(C) made an announcement about a late breaking news story about three British soldiers who were accused of stopping cars and robbing the occupants. The PAO said it was true and an embarrassment to the UK government and was being handled as a UK matter. A UK newspaper ran the story and MNB(C) immediately brought the story to KFOR's attention.

CHAPTER XXIV

Communications Systems

Larry Wentz

Introduction

The Kosovo public telecommunications (PTK) infrastructure suffered from a lack of investments and old equipment. It had poor countrywide coverage and one of the lowest connected subscriber populations in Europe—about 6 lines per 100 persons. The PTK services were problematic before the air war, but Operation Allied Force surgically neutralized any functioning capabilities that may have existed then. The lack of a functional civil telecommunications infrastructure created some interesting challenges for the civil and military participants as they deployed into Kosovo. The military deployed with their own military tactical systems while the civil organizations had to be more creative in supporting early communications needs. Handheld radios, cell phones, and satellite phones were the norm at the outset until contractor provided services were implemented to fill their needs. There was a need to coordinate, collaborate, and share information between the civilian and military entities, but this was complicated by the lack of a civil telecommunications infrastructure.

System interoperability and information sharing between NATO, national militaries, international organizations, such as the U.N., and the NGOs in Kosovo were problematic. A variety of stovepiped secure and non-secure communications and information systems (CIS) populated the Kosovar landscape in support of the KFOR, UNMIK, information operations, and NGO operations. As a result, there were interoperability challenges and security disconnects to be addressed.

The U.N. extended its commercial services based global communication and information system into Kosovo to provide voice and information network services (including e-mail and Internet access) to all of its

deployed elements. The UNMIK network was a mixture of leased services and U.N. provided services. NATO contracted a commercial turnkey service for its KFOR voice and data network services. There was also a military tactical network overlay to support essential KFOR command and control needs. The CIS services that supported KFOR headquarters were extended to its five Multinational Brigade headquarters as well as KFOR support elements and NATO and SHAPE Headquarters elements. Each of the five Multinational Brigades deployed a mix of military tactical and commercial capabilities that served the needs of their respective sectors including support to the multinational units assigned to the lead nation of each sector. For example, the U.S., as the lead nation for MNB(E), extended telecommunication services to the Russian, Polish, and Greek elements assigned to it.

A wide variety of off-the-shelf commercial products and services offer so called military-unique features—rapid, globally deployable, self-sustaining communication capabilities with voice and data network encryption. NATO and Allied militaries moved towards more extensive use of a combination of commercial and military systems. In fact, private sector products and services have become a major source of communications and information systems support for peace operations. They support both fixed and deployable military command and control packages. The emerging strategy for sustained operations is to replace the military tactical capabilities as soon as possible with commercial capabilities. The intelligence community also uses commercial capabilities extensively to support forward deployed elements and to provide access to rear area intelligence centers and analysis teams.

This chapter introduces the reader to the challenges of deploying and interconnecting civil-military CIS systems in an environment void of a civil telecommunications infrastructure. The fixed and deployable systems used to support UNMIK, KFOR, IO, and NGO operations are discussed as well as the challenges of interoperability in a mixed environment of civil and military organizations and systems. The role of commercialization of military communications and information systems is also emphasized. Reconstruction of the PTK infrastructure, including limited commercial cellular service and emergence of Internet service providers and Internet cafés are discussed as well.

Firsthand Opportunities

I had the opportunity to visit many of the MNB(E) communications sites as well as KFOR and UNMIK communications operations. LTC Kokinda, U.S. Army, 121st Signal Battalion, arranged visits to the U.S. tactical and commercial communications facilities on Camps Bondsteel and Montieth, the U.S. tactical sites at the Russian, Polish, and Greek base camps, and the U.S. communications supporting the 1-187 Infantry base camp at Vitina.

MAJ Lin Crawford, U.S. Army, 7th Signal Brigade, organized a visit to the EAC POP, referred to as The Rock, on Camp Bondsteel and to a CONOPS package deployment at outpost Eagle's Nest. MAJ Lee, U.S. Army and TFF G6, organized a visit to the TFF operations center and provided an overview of the communications and information systems supporting the ops center. During the visits to the U.S. facilities, TFF signal personnel provided informative and detailed briefings on the equipment and capabilities. The soldiers I met were the most professional and certainly understood the systems they were responsible for operating and maintaining.

During a visit to KFOR, COL Muller, FR. Army, KFOR J6, provided a briefing on the KFOR communications and information systems and MAJ Irby, U.S. Army, MNB(E) LNO to KFOR, provided a tour of the new KFOR HQ operations center in Pristina. On a visit to UNMIK, Andy Fleming, UNMIK communications, provided an overview of the communications and information systems supporting UNMIK and the four pillars, including UNMIK police and the emergency services radio network. Paul Currian and his staff provided an overview of the Humanitarian Community Information Center in Pristina and its efforts to establish an information-sharing network using their Internet Web site and other collaboration tools.

The Challenge

No single civil or military organization was responsible for planning, implementing, and operating the communications and information systems that supported the civil and military players. There was little to no civil-military CIS coordination prior to deployment, and even within the military there was only limited sharing of CIS deployment

information among coalition partners. The Kosovar civil telecommunications infrastructure was essentially nonexistent and could not be relied upon as a viable source of service and connectivity for military use. There was little reconnaissance of likely military tactical communications sites and headquarters facilities to guide the planning and deployment. The timeline for contingency planning was short and end states and command relationships were not well defined. As a result, information needs were ill defined, adding additional challenges for configuring and dimensioning the communications and information networks deployed.

NATO and national military restrictive security policies generally prevent the interconnection of the NATO and national military classified networks. Funding and policy issues preclude the open interconnection of the unclassified civil and military networks.

A coalition CIS architecture did not exist to guide planning and deployment in support of the KFOR operation. However, NATO, SHAPE, and many of the same member nations had been working together since the IFOR operation so there was an extensive experience base that facilitated putting the pieces of the KFOR and MNB networks together to support the deployment into Kosovo. Within the European theater, U.S. organizations such as EUCOM, DISA-EUR, USAFE, NAVEUR, USAREUR, 5th Signal Command, and 7th Signal Brigade had established good working relationships. The successes of the NATO and U.S. efforts were, however, not without significant monetary and personal expense. Staff worked 18 hours a day, 7 days a week to make it happen. For the United States, organizations such as EUCOM required staff augmentation to get the job done.

The support of the Joint Staff to make contingency money available to acquire the communications capabilities to support the operation was key as well. A strictly enforced battle rhythm was also a key to success. The EUCOM J6 Joint Communications Coordination Center (JCCC) along with the J6 Crisis Action Team (CAT) was key to keeping the schedule. The EUCOM J6 also established a Future Plans Cell that hosted several meetings with the component representatives and DISA-EUR that led to the development of an Annex K for the U.S. operations plan.

In spite of the theater experience, coalition communications interoperability may have taken a step backwards in the Kosovo

operation. In Bosnia, at least a federated voice network existed to provide non-secure voice communications among the military and civil participants, but in Kosovo this was not the case. The KFOR voice network, the KPN, only had limited interconnectivity with some of the MNB military voice networks. For example, there was no direct KPN interconnection with the MNB(E) U.S. tactical (MSE) and fixed (*Dragon* package) network but there was a USAREUR operator interface with the KPN. There was a very limited KPN access to UNMIK and the PTK network in Pristina. KPN phones were placed in MNB command centers to provide access to KFOR headquarters and other elements. The KPN was interfaced with the NATO IVSN so this provided access to NATO organizations and nations having IVSN service. Extensive automated interfaces among the national tactical voice systems and the KFOR network were not as prevalent as in Bosnia—KFOR and the MNBs tended to operate stand-alone voice networks.

Frequency management coordination was a challenge in spite of the fact that there was already a structure in place. Contributing factors included a lack of information on deployed military units and civil agencies and NGOs, lack of information on available spectrum, lack of user awareness of frequency management coordination process, poor planning, late requests, and a lengthy approval process. There was an AFSOUTH Theater Frequency Management Cell (TFMC) that worked with the EUCOM Balkans Spectrum Management Cell (BSMC) to coordinate and manage the theater frequency requirements in Kosovo. There was a Regional Frequency Management Cell (RFMC) at KFOR (J6) that worked with the TFMC and the MNBs to coordinate requirements and perform any necessary host nation coordination. The KFOR frequency manager was also responsible for managing all commercial access as well. The U.S. Navy/Marines and Air Force did their own frequency management and coordination with EUCOM and the BSMC. For the Army, the MNB(E) TFF Frequency Manager (G6) worked with the BSMC and coordinated frequency requests with the KFOR RFMC. The TFF frequency manager used the NATO CRONOS and KFOR Secret Network to communicate frequency requirements to KFOR, who then deconflicted and assigned frequencies. The KFOR approval process could take 2 to 3 weeks. In order to provide some improvement in the process and provide the MNBs some flexibility, the KFOR frequency manager authorized the MNBs to manage their own VHF-FM spectrum (30-89 Mhz). This action improved the MNBs ability

to manage the range of frequencies more effectively and there was a desire on the part of the MNBs to be given added flexibility to manage more of the spectrum in their sectors.

The civil telecommunications infrastructure was extensively damaged and could not be used to support civil and military needs. Limited local calling was available in towns and cities, but the national network was undergoing reconstruction and so national and international connectivity was extremely limited. A NGO rep explained to me at a meeting at UNMIK in Pristina that it was easier to simply get into a car and drive to someone's office to meet face to face than to try to use the civil or military communication systems. There were multiple stovepiped military and civil systems. The root cause of this situation was not technical, but largely a political issue coupled with some continuing distrust between military and non-military organizations and outdated restrictive NATO and national policies on the interconnection of networks and sharing of so-called military information. The unwillingness to provide some limited secure connection for the respective data networks exacerbated the situation. There were some limited interconnections. For example, the military unclassified data networks, such as the U.S. NIPRNET and KFOR unclassified WAN, were interfaced with the Internet through firewalls. A NATO guard gateway interfaced its classified KFOR command and control network, CRONOS, with the Intel dissemination network, LOCE. KFOR classified data networks were not interfaced with MNB national military classified data networks.

Face-to-face, sneaker net, handheld commercial radios, GSM cellular, satellite phones, and the Internet became the coalition modes of communication in Kosovo. The Internet, in fact, became the Coalition Information Sharing Network among KFOR, national militaries, UNMIK, international organizations, NGOs, and local civilian organizations. Civil and military elements participating in Kosovo, as well as those supporting them, constructed Internet Web sites that were used to inform and share information. The issue quickly became one of finding the information they could use—more powerful information discovery tools were needed. The U.N.-sponsored Humanitarian Community Information Center in Pristina was a prime example of an organization using an Internet Web site as an effective means to inform and share information. There were also the Internet-related information assurance issues that needed accommodating and managing. NATO and national

COMSEC, INFOSEC, and virus detection capabilities were employed to protect their respective networks. There was, however, no common approach to protecting and monitoring the various data networks.

Information assurance was a constant challenge. The I Love You virus not only infected the unclassified networks, but also found its way into some of the classified systems as well. NATO and U.S. Computer Emergency Response Teams (CERT) were used to monitor their respective networks for intrusions, viruses, and other violations. Red teams were used to assess OPSEC, INFOSEC, TRANSEC, and COMSEC posture and identify vulnerabilities. For NATO, there were some national restrictions on TRANSEC monitoring that limited the breadth and depth of this activity across all command levels. NATO also needed to make improvements in its tools, policy, procedures, and training. They needed improved intrusion detection and protection tools—smurfing, spamming, and mail bomb attacks were experienced on the unclassified network that was connected to the Internet. Classified information was found attached to unclassified e-mails and classified information was found posted on unclassified bulletin boards. There were NATO-related information assurance organizational policy disconnects—competing NACOSA, NATO NOC, and NC3A roles. These were representative of some of the challenges facing NATO and national information assurance activities.

The successes of the HCIC and the IPKO Internet project will no doubt serve as models for future humanitarian emergencies. Building a shared Internet infrastructure allowed international organizations to benefit from more reliable communications at a much lower cost and enabled them to take advantage of shared access to databases and other Internet-based applications to improve their effectiveness. When the Kosovo crisis ends, the IPKO Internet infrastructure will no doubt be left in place and local people trained to maintain it—this, in fact, has already started to happen.

There were other factors that militated against building a civil-military (or even a military) federated network to support the multinational coalition peace operation. They include varied technical capacities among the participants, differing technical standards, security constraints, and funding constraints. Further complicating the situation was the fact that NATO and many of the non-U.S. nations had limited ability to deploy the CIS necessary to support the tactical headquarters elements. For example, NATO had not yet acquired an adequate CIS

capability to support its forward-deployed tactical headquarters in Kosovo, including the first responder elements, such as the ARRC, in its role as headquarters KFOR. NATO policies restricted the removal of CIS equipment procured for peace headquarters for use in support of tactically deployed headquarters elements. NATO common funding for acquiring CIS capabilities to support a deployment were not made available before the NATO activation order was issued, which further delayed development of the operational command and control capability. As a result, NATO had to rely on Allied national military tactical command and control systems to support initial NATO tactical headquarters deployments and fill the gap until commercial capabilities could be acquired and implemented.

Communications network vulnerabilities were not always manmade. For example, lightning struck the KFOR commercial satellite terminal in Pristina on a Saturday night and blew a number of the IDNX cards, taking down the KFOR headquarters communications and information network. It happened over a weekend when the contractors were unavailable and there was a problem finding the contractor personnel to conduct repairs. Also, there were no spare IDNX cards on hand at Pristina or in Europe and the contractor had to get replacements from the U.S. Some limited reconfiguration was possible by using the NATO mobile SHF military satellite communications capability and salvaging some IDNX capability. The temporary fix provided extremely limited CRONOS and Kosovo Secret Network service and only some of the Kosovo Private Network telephone numbers were working (with no connectivity to UNMIK and very limited local PTK access). It took a couple of weeks to get the KFOR system restored to its normal operational capability.

CIS equipment delivery delays to KFOR were a problem as well. NATO priorities for use of national military aircraft were low and frequently preempted by local and national priorities. Military aircraft flying to Pristina avoided the customs delays and the 7-hour drive from the Skopje, Macedonia airport. This became a particular operational problem when the ARRC transferred authority to LANDCENT who had no signal support element. NATO had taken an action to implement a contractor turnkey service, but delays in delivery of equipment contributed to NATO's inability to quickly replace the military communications capabilities being withdrawn by the ARRC departure. In the end, a

German signal unit had to be deployed to temporarily fill the gap until the NATO funded service came online.

Pervasive use of commercial handheld sports radios (e.g., the Motorola *TalkAbout*) for military operational purposes, although effective, created some OPSEC conflicts for KFOR and TFF. Internet Web sites were another challenge—soldiers posting personal photos taken of base camp layouts and military equipment such as helicopters unintentionally revealed potential force protection vulnerabilities. Unedited e-mail discussions of sensitive military incidents gave wide visibility to potential operational vulnerabilities. Cellular phones also allowed unedited reporting.

During the initial phase of the deployment, the Army's 82nd Airborne and Marine's 26th MEU had to fight dust, dirt, and water to keep their systems running in Kosovo, including the *Toughbook CF-45* portables—rugged or not, all automation suffered in the elements. For the longer haul, the TFF G6 had a continuous battle with dust and dirt getting into computer drives and keyboards—a fine dust, generated by heavy vehicle traffic on the dirt roads of Camp Bondsteel, filled the air and got into the offices where computers were located. In the field and on bases, special protective and backup measures were employed—waterproof keyboards, covering and cleaning servers and workstations, cleaning office areas daily, keeping spares in safe places, and daily backups of files on mass storage devices, such as CDs and ZIP disks.

Commercialization

As the in-country situation stabilized, commercial communications and information systems replaced a large part of the NATO and national military tactical networks. NATO contracted with SPACELINK to install a commercial voice and data network for KFOR. The U.N. extended its global commercially based voice and data network to support UNMIK and MNB nations introduced commercially based services as well. In MNB(E), the U.S. Army used its commercial Dragon package that supported command and control, base communications, and command support needs, including telemedicine for the MASH hospital on Camp Bondsteel. For sustained operations, the U.S. Army CONOPS package used a mix of military and commercial products to support CIS needs for contingency operations such as the deployment of U.S. forces to

Metrovica to support the French during riots. IRIDIUM saw some use and commercial SATCOM, INMARSAT, and GSM cellular were major players. In addition to the limited MOBTEL cellular capability, new cellular capabilities were introduced both commercially and by the military. Alcatel introduced a commercial GSM network. UNMIK, KFOR, and the MNBs installed cellular capabilities and the UAE provided its soldiers with cellular phones that allowed them to call home. The U.S. installed IFONE (with STU-Q44 sleeves for secure operations) on Camps Bondsteel and Montieth and UNMIK, KFOR, and the British installed the Nortel *TETRAPOL* cellular system. Sprint also provided MWR commercial telephone access (soldiers used calling cards) at Camps Bondsteel, Montieth and Able Sentry. The Orion commercial satellite was used to extend the commercial MWR service into Kosovo. The U.S. joint broadcast satellite system was used to support wide-band intelligence and other information and UAV video dissemination to MNB(E) and KFOR headquarters.



Figure 1. *TalkAbout* Radio

There were also some creative new uses of commercial products. In the U.S. sector, the Motorola *TalkAbout* recreational two-way radio was used extensively for dismounted, convoy, and base area communications purposes. It became a status symbol and nearly everyone had one clipped to his or her flack vest (Figure 1). There were also other types of commercially available hand held radios that were used by the NGO, UNMIK, and KFOR personnel. Use of these unprotected radios introduced OPSEC risks that needed to be carefully managed. A surprise entry was the extensive use of the 3Com *Palm Pilot* for taking notes and exchanging information. It was not unusual

to see U.S. military staff officers scratch notes on their *Palm Pilot* during a meeting and then use the infrared link to exchange notes or task another officer. Commercial remote sensing and Geographic Information Systems were used by the military for improved mission planning and by the non-military, such as the U.S. State Department and the U.N., for humanitarian assistance and reconstruction planning and assessments that included refugee returns and mine clearing actions. Once again, GPS played an important role supporting position location and navigation needs, especially in an environment where maps were not adequate to support operational movements in areas that bordered Serbia.

The civil-military use of commercial products and services overcame some of the interoperability short falls, but had special considerations and sometimes unintended consequences that need to be better understood and more appropriately factored into the planning, acquisition, implementation, and operation. For example, perceived lower costs and reduced acquisition times have risk factors that need to be considered. Availability and delivery of commercial products can be adversely driven by the fact that the military must compete with commercial customers and when demand exceeds supply, which can have cost and delivery implications. Leasing long haul services from PTTs takes time and service performance does not always meet military expectations and connectivity needs. The military is not the PTTs only customer and the PTTs do not provide maintenance services every hour of the week. Additionally, since the services are contracted, it takes time to work the provisioning through the government and PTT bureaucratic processes. Even with EUCOM J6s authority for exceptional provisioning in theater for U.S. forces, the process was still driven by the PTTs reaction time. Durability and maintainability of commercial systems and services in the tactical environment present contracting and contractor performance challenges as well. This is a major issue in terms of ability to meet assured service expectations in an operational environment—there are O/M, service restoration and recovery, and spares and repairs implications that need to be specified and contracted at the outset. Contract modifications can be very expensive.

Unexpected equipment modifications and contract changes can escalate costs quickly. Lead times for acquiring commercial products and services can still take months. Foreign military sales can take 6 to 9 months regardless of the urgency. Turnkey communications and

information service procurements can sometimes overcome the shortfalls of first buying the pieces and then building the network, especially where time constraints may preclude the necessary system engineering analysis, design, and specifications.

Contractor statements of work must define all requirements of the contractor and the government, including military support arrangements in the operational environment. Requirements need to be base lined before installation begins—unplanned site, unit, and office moves can have significant performance and cost impacts. Contractors sometimes make mistakes (delivery locations, customs, equipment certifications, security accreditation, satellite landing rights, etc). Spares and repairs concepts of the contractor need to meet military sparing concepts and system restoration and availability needs. Contractor response times need to be defined within the context of the operational environment. Using military transportation means in the AOR can save installation time and costs.

Commercial product modernization (18-month-or-less life cycle) can have impacts on interfaces with existing equipment that may need to be upgraded or replaced since backward compatibility cannot be assured. Often, the user asks for a solution that is based on his past experiences without understanding the longer-term impact of this technology choice. For example, NATO has been using 10BaseFL fiber LANs, but industry is moving to 100BaseFX, requiring NATO to replace both the fibers, interface cards, and switches already deployed. Commercial products and services can introduce OPSEC challenges that need managing. Using standard commercial products requires special consideration for protection against physical shocks, fluctuating power sources, dust, dirt, and water. Finally, commercial service support to military operations has yet to be stressed by hostile actions, so the contractors and systems performance and responsiveness under live fire is still an unknown.

In terms of unintended consequences, 1999 was the year of Y2K fixes, and NATO found themselves competing with major industries for commercial communications and information systems products. A last minute approach by some industries to solve their Y2K problem was to employ full-scale replacement of their information systems. This placed a heavy worldwide demand for commercial communications and information system products. When demand exceeded supply, the person with the most money got the products.

NATO contractor selection is based on lowest compliant bid, and so quality of support can vary. NATO used NAMSA for shipping to Kosovo with reasonable success. However, there was one incident where the delivery of some urgently needed spare parts to KFOR were delayed for several days because NAMSA closed its operation for the weekend at 1 p.m. on Fridays and the equipment could not be shipped until the following Monday. DHL was also used successfully to deliver to Skopje, Macedonia where military transport could then be used to deliver it to Kosovo.

Civil Communications and Information Systems

Kosovo was not an information rich environment before the air war. When KFOR entered the country, there was no functioning postal service, print media, radio, TV, or telecommunications. The commercial power and water was problematic as well. There was a very limited GSM cellular capability that continued to operate after the air war. The system was owned by MOBTEL Serbia and calls over this system were routed through Serbia. The extent of the civil telecommunications damage became visibly obvious in places like downtown Pristina where I could see, even a year later, the effects of a cruise missile attack that had destroyed the telecommunications center across the street from the building now being used for UNMIK headquarters (Figure 2).



Figure 2. Telecommunications Facility Pristina

In Kosovo, UNMIK deployed multiple fixed and mobile voice and data networks. The international media arrived with mobile satellite and TV capabilities, satellite phones, GSM cellular phones, and laptops. NGOs relied heavily on handheld commercial radios, the PTK (where it existed), GSM cellular phones and in many cases, simply face-to-face communications. The local factions, including organized crime, used cellular, the PTK where it existed, and in some cases, two-way and ham radios were used to pass information and to organize demonstrations.

Although international satellite TV antennas could be seen on apartment buildings in major cities, after a year of KFOR and UNMIK presence, national television was on the air only a few hours a day and a fully functional telecommunications and postal service did not exist in June of 2000. Newspapers were being published and radio stations, both Albanian and Serbian, were coming back on the air. A non-profit Internet service provider, IPKO, was created in Pristina and Internet cafés started to appear in the major cities. The Internet became a lifeline to the outside world for the civilian population. E-mail was not a mere luxury. For many people in Kosovo, it was the only mail. The Internet also became the de facto coalition information network that allowed civil and military organizations to exchange unclassified e-mails and attachments, post information on Web sites, and search the Web for information relevant to Kosovo.

UNMIK CIS Network

The initial UNMIK contingent arrived essentially without communications. They had some GSM cellular phones that could be used on the existing MOBTEL network that provided very limited coverage of Pristina and some other areas, such as the Serbian border. The ARRC provided the UNMIK contingent PTARMIGAN service until it could get its own network up and running.

A U.N. leased commercial C-band VSAT network and in country microwave network were used to extend the U.N. Department of Peacekeeping Operations' (DPKO) global network into Kosovo and provide coverage to UNMIK headquarters operations and remote locations. The DPKO Field Administrative Logistics Division's Communications and Electronic Services Section was responsible for acquiring, implementing, and maintaining the network that supported

UNMIK operations. The U.N. network offered voice, data, and video services to the various pillars of the UNMIK organization and to the U.N. Support Services (Figure 3). There were 30 to 35 DAMA terminals planned to support the final network configuration. About one-third of the network connectivity was planned to be VSAT and two-thirds microwave (commercial E1 2 Mb/s links). The U.N. also leased a 2 Mb/s link from IPKO in Pristina that provided connectivity to U.N. headquarters in New York. Internet service was leased from IPKO as well. The UNMIK telephone switch was an Erickson *MD-110*. KFOR used the same type switch for its voice network, the KPN, and there were plans to interconnect the two switches.



Figure 3. U.N. Communication Satellite Terminal at Strpce Office

UNMIK-KFOR headquarters voice communications used operator assisted calling via the local PTK in Pristina. The U.N. data network was not interfaced with KFOR or the MNB networks, but unclassified e-mails and attachments could be interchanged via the Internet since the UNMIK, KFOR, and MNB unclassified data networks had Internet gateways. The plan was to have the UNMIK data network serve all headquarters and dial-up access would be provided for the major areas such as Gnjilane. UNMIK police stations were to be networked and connected to UNMIK police headquarters in Pristina.

As the U.N. presence grew and reconfigured, there was a lot of U.N. office movement that needed to be accommodated. This kept the

communications and information systems staff quite busy accommodating the changes. The U.N. also provided secure communications, both fax and phone, over the VSAT network. The SRSG, the police commissioner, and COMKFOR used the secure services. Eventually, KFOR and CIVPOL that were collocated at major sites would be given access to the UNMIK network as well. KFOR J3/J6 had VSAT links into the UNMIK network.

The U.N. used MOBTEL from the outset of the operation. The system provided international and local coverage in Pristina, the external borders, and in the north. Belgrade would periodically disconnect the international lines. Early into the operation, Motorola tried to get permission to install a countrywide cellular service, but was unable to do so because the international status of Kosovo was still unclear and Serbia held the international legal rights for Kosovo telecommunications.

Three U.N. radio nets were in various stages of implementation to support emergency services and UNMIK civil administration. The analog VHF/UHF emergency response network was the initial network and it would remain operational after the planned upgrade to a countrywide digital UHF network was implemented. All UNMIK police radios were cross-linked between VHF and UHF. The UNMIK fire and ambulance contact channels were programmed to be compatible on all UNMIK police handheld radios to facilitate direct police assistance at the scene of a fire or other emergency. Locations where KFOR MPs and UNMIK police were collocated, KFOR had access to the U.N. radio network. Agencies such as UNHCR and OSCE had HF radios (CODAN) that were difficult to use. NGOs under UNHCR bought their own radios and applied for and registered frequencies with UNMIK. Abuses of the U.N. radio network were managed by UNMIK.

The digital UHF network was planned to be two-thirds U.N. civilian and one-third UNMIK police. There were 78 UNMIK police locations and some 170 locations to be served in general. For short-range communications, the simplex channel was used. Fully linked regional radio sites were initially installed in Pristina, Prizren, Pec, Gnjilane, and Metrovica. A radiotelephone interconnection to the UNMIK telephone network was provided at Pristina. Each geographic coverage area had two collocated, overlapping radio cells, one 8-channel and one 4-channel, except for Pristina which had three 8-channel cells. The network was to be expanded over time by putting up repeater sites to improve

coverage and performance. In order to further extend the coverage, two IDR talk-group linked repeaters were proposed for areas such as Strpce, Kacanik, Kamenica, Novo Brdo, and other towns for wider coverage.

The U.N. peacekeeping budget was used for building communications to support U.N. operations and the systems acquired and installed to support these operations will be pulled out when the U.N. leaves Kosovo. There was also a UNMIK Kosovo budget that was based on customs taxes collected at the Macedonian, Albanian, and Montenegro borders that served as a source of funding for U.N. communications as well. The local Albanian and Serbian civil administration leaders did not have access to the U.N. system.

NGO CIS Capabilities

The NGOs tended to have simple communications and information systems. They used personal cellular phones (referred to as handies), handheld radios, and the local phone system where it existed—generally they found it easier to meet face to face than try to use local telecommunications. The Internet was also a favorite means of communicating (see the HCIC at <http://www.reliefweb.int/hcic/index.html> or Interaction at <http://www.interaction.org/>). Some NGOs had their own laptops and others with the larger NGOs had workstations with Internet access. Many used e-mail to share information regarding supply routes and meetings while others simply relied on manual means—note pads and pencils and face-to-face meetings.

PTK

The Kosovar telephone network was operated and managed by the Posts and Telecommunication Kosovo (PTK), a Serbian organization. With the deployment of KFOR and departure of the Serbs, the management and staffing was taken over by an inexperienced Albanian staff. The PTK consisted of a major transit center in Pristina that was connected to Belgrade, Nis (FRY), and Skopje (FYROM) for international access. A microwave and coaxial cable network interconnected the seven main switching centers located in Pristina, Metrovica, Gnjilane, Prizern, Urosevac, Pec, and Djakovica and a cable network supported the local distribution.

Before the conflict, Kosovo had the second lowest telephone penetration rate in Europe with about 6 lines per 100 persons. There were slightly more than 140,000 subscribers (about 6.5 percent of the population) on the national network. Very little investment had been made in the region through the 1990s and most of the network equipment was very old. UNMIK gave the PTK authority to continue to provide post and telecommunication services in Kosovo on an interim basis, using existing public postal and telecommunication assets.

The allied bombing took out the transit center and a 10,000-line subscriber switch in Pristina and a large portion of the transmission backbone and distribution networks. Although most local exchanges remained in service there were no spare parts and no test equipment, tools, or vehicles for maintenance. The current Albanian staff of the PTK had, in general, not worked in the telecommunications industry for the past 10 years and their technical skills needed to be upgraded. Management staff needed training in the use of new technologies such as digital switches, transmission technologies, and new local loop technologies, in customer service issues and in network strategic planning. Operational staff needed training to enable them to maintain modern equipment. Technical training was expected to cost DM 300,000. The commercial environment in which PTK operated also changed significantly in the past 10 years and senior managers in the organization needed training to develop their management and financial administration skills. Training for executives included both management seminars and courses in Kosovo and international visits to other telecommunications enterprises. The inability to replace Serbian technical staff and managers with qualified Albanian staff served to further complicate the early repair and reconstitution of the national telecommunication services. For example, while with the U.S. civil affairs team in Vitina, we visited the telephone office, which was trying to find more qualified technicians. A Serb who was employed by the PTK before the air war and was living in the Serbian enclave in Vitina refused to come back to work for the PTK or help fix problems with the Vitina telephone equipment.

By June 2000, the PTK had restored a minimal microwave network linking major cities that restored some long distance and international telephone services in major switching centers. However, the capacity of the system was still extremely limited and insufficient to handle the volume of traffic generated. It was estimated that 50 percent of the regional towns still had

not been reconnected to the national network, leaving them with only limited local calling service. Significant investment would be required over a period of time to expand and modernize telecommunications services in Kosovo to meet the economic development needs of the territory and restore national and international services. For example, the main transit center building in Pristina was so badly damaged that its offices had to be moved to other buildings (which were also damaged). The collection of telecommunication revenues was a significant problem as well. Only about 30 percent of the accounts were currently being collected, largely because of problems with customer identification and billing. The PTK urgently required an improved billing system to increase the proportion of revenues collected.

Good telecommunications services were essential for reconstruction and development in Kosovo. The international presence in Kosovo generated new business opportunities for the telecommunications sector, however, as noted, the telecommunications infrastructure urgently needed to be repaired and operations and management staff required training before further development of services could be considered. The Swiss government provided DM 400,000 worth of essential tools to enable PTK to resume operations. EU funding (DM 12 million) had been committed for essential repairs to the telecommunications network. Additional donor commitments of around DM 55.7 million were required to support repairs and planned modernization initiatives.

Commercial Cellular

MOBTEL Serbia provided GSM service to Pristina and some other areas of Kosovo and they had plans to significantly extend the coverage to the entire province of Kosovo before the war. MOBTEL, the first and the largest Serbian mobile telephone system operator in Yugoslavia, was founded on April 15, 1994, as a joint venture of BK Trade from Moscow and The Public Company for Postal, Telephone, and Telegraph Services (PTT) from Belgrade. MOBTEL operated as a limited liability company with 51 percent owned by the BK Trade and the remaining 49 percent controlled by the PTT. The service continued to work in Pristina after the war—the server was located in Nis (FRY). The limited coverage of Kosovo also extended into selected areas along the border with Serbia.

A new GSM network, *VALA 900*, a joint venture between Alcatel and Monaco Telecom, commenced operation in Pristina in February 2000 with plans to expand coverage to 7 major cities and the airport. The network was planned to be entirely self-funded and to provide essential communications pending full reinstatement of the fixed telecommunications network.

IPKO and Internet Cafés

The idea of creating an Internet service provider (ISP) that would put Kosovo in touch with the rest of the world through e-mail started with two young Americans who teamed up with Mr. Akan Ismaili, a Kosovar Albanian, to form Internet Project Kosovo (IPKO). Teresa Crawford was a graduate student at Syracuse University and a founder of the Advocacy Project, which used the Internet to advance human rights. While in the region, she had researched the possibility of setting up Internet service at Pristina University but it had turned out to be impractical. In Kosovo, she met another young American, Paul Meyer, who was working for the International Rescue Committee, a private volunteer organization. Through refugee contacts, he learned there was a 3.8-meter satellite dish stranded in a Macedonia refugee camp whose occupants were returning to Kosovo. A California company, Interpacket, had donated the dish. Mr. Meyer persuaded its owners and operators to donate the dish and satellite link to the cause of rebuilding Kosovo.

There was a slight initial glitch in the attempt to set up an ISP. The PTK managers installed by the United Nations to run the Kosovar phone system wanted to control Internet service providers in Kosovo, but Ms. Crawford and Mr. Meyer refused, not wanting IPKO to become part of the bureaucracy. Luckily, the PTK failed during the negotiations, and the U.N. approved an independent nonprofit service. A loan from the International Rescue Committee allowed them to move the dish and add microwave links in the city. IPKO received initial support from the UK Department for International Development, Interpacket Networks, and the Sudikoff Family Foundation as well. IPKO went online on September 20, 1999 at their headquarters in downtown Pristina. IPKO was spun off as a local NGO in March 2000.

IPKO was the leading Internet service provider (ISP) in Kosovo. A direct satellite link to the U.S. Internet backbone provided service in Pristina since September 1999. Users were connected through a network of wireless microwave antennas. An antenna and router was installed at each client site that allowed them to connect their entire network to the Internet 24 hours a day. For example, local Albanian newsrooms were plugged into the Internet via the IPKO and plans were being made to connect Radio 21, a popular independent station in Pristina, so that it could broadcast news 24 hours a day on its Web site. Internet service was provided to more than 120 organizations. There were both paying and non-paying customers. The paying customers included every U.N. agency, NATO, OSCE, World Bank, diplomatic offices, major NGOs, banks, companies, government offices, and Internet cafés. Free service was provided to key local civil institutions including the University of Pristina, hospitals, libraries, schools, local NGOs, and local Kosovar media. In August 2000, dial-up Internet service was offered that provided the opportunity for thousands of people across Kosovo to connect to the Internet from their homes and businesses if they had PTK service in their area.

IPKO planned to launch a technology training institute in Pristina to provide Kosovars with the technical skills they needed to prosper in the Internet age. Without a pool of well-trained technicians, Kosovo would not be able to benefit from the advantages of new information and communication technologies. The IPKO Institute was being designed to train the technicians who would wire Kosovo. The Institute would initially offer courses in networking, system design, and web development. The courses would primarily be taught remotely through the Internet with assistance from local tutors. The Institute entered into a partnership with the Noroff Institute in Norway to provide year-long distance learning courses. The Institute also planned to be a certified Cisco networking academy. The Institute would be a self-sustaining venture. While scholarships would be provided to some particularly needy students, most students would be expected to pay tuition to cover the running costs of the Institute. A number of major employers had also agreed to sponsor the education of their technical employees. The Institute was planned to be located on the top floor of the National Library of Kosovo. IPKO had already started the construction process as classes were scheduled to begin in October 2000.

Internet cafés also sprung up in the major cities. Just across the street from the shattered glass and concrete rubble of the bombed-out Pristina police station, people lined up. They were nervous, impatient, and anxious—not for food, or shelter, or handouts, they were waiting to get online. Last year there was not a single Internet café and now there were at least 9 in the city and about 20 in the Kosovo region. The EasyNet Café stayed open 24 hours a day, connecting people to the Internet at less than \$2 an hour. At this price, going online was cheap enough for even hard-pressed Pristina residents to afford a short visit. Adding to the interest was the fact that many young ethnic Albanians were forced to spend years abroad and when they returned, they created a demand for Internet access. The price at the EasyNet Café dropped by half after midnight, when young people flock to the terminals to log on to chat groups so they could speak to relatives and friends in the United States and around the world. In the battle-scarred city, the Internet became a lifeline to the outside world.

The Military Communications and Information Systems

KFOR and its MNBs deployed independent and separately managed tactical and fixed voice, message, data and VTC networks. Even within the U.S. military where the objective was to offer integrated services to the deployed commander and his troops, there were multiple independent stovepiped C4ISR systems. Nations assigned to MNB(E) deployed their own national tactical capabilities with independent connectivity to their national capitols. The U.S., as the lead nation for MNB(E), provided limited voice and e-mail service to the multinational units assigned to it. Commercial and military SATCOM and leased E1 links were the major long-haul digital communication bearers. Both military and commercial satellite bandwidths were being pushed to their limits. Other commercial communications and information systems played important roles as well. There were INMARSAT and cellular phones. Iridium had some limited use.

Because of the inoperable Kosovar telecommunications and power infrastructures at the outset of Operation Joint Guardian, KFOR, and the MNB-led nation military elements had to deploy with their own tactical communications and information systems and electrical power

sources. Furthermore, unlike Bosnia where there was a functioning U.N. VSAT network that NATO used extensively during IFOR deployment, there was no U.N. network in Kosovo at the outset. The ACE Rapid Reaction Corps (ARRC) was the initial entry KFOR headquarters' element and the UK, as the ARRC host nation support element, used the UK PTARMIGAN tactical system to support the ARRC CIS needs and connectivity with the MNB headquarters. The NATO Mobile Communications Module (tactical SHF SATCOM) was deployed to support connectivity to Echelons above Corps (EAC). National tactical systems such as the U.S. TRI-TAC/MSE, French RITA, UK PTARMIGAN, Italian SOTRIN, and German AUTOKO were deployed to provide their respective MNB sector communications. The initial KFOR command and control net used UHF TACSAT, HF RATT, and secure VHF radios.

Secure voice and data communications for tactical headquarters were still lacking, in spite of this being an issue in Bosnia for the IFOR headquarters deployment—the ARRC was the initial entry headquarters element in this case as well. On the other hand, some of the lead nation tactical systems supporting the MNB elements were much more capable. For example, the U.S. deployed its MSE tactical systems (augmented with the USAREUR Fly Away and Data packages). A DISA POP was installed at Camp Able Sentry (location of TFF Rear) in Skopje as well and it was connected to Camp Bondsteel via a TACSAT link, and to Heidelberg and Vahingen, Germany via a SPACELINK commercial satellite link. The 26th MEU, who were part of the initial entry force, deployed their JTF Enabler package to extend a similar set of DISN secure voice, data, messaging, and VTC services including supporting JDISS and CRONOS/LOCE access as well. The JTF Enabler Package accessed the DISN via a TACSAT link to the Croughton, UK STEP. UHF TACSAT, VHF and HF radio nets, cellular, and INMARSAT were used to support the tactical command and control and intelligence needs with the VHF net being the primary net supporting command and control of units. There was a problem with VHF performance due to the mountainous terrain of the area. Retransmission sites were needed to improve reliability and coverage. However, because of force caps and force protection rules requiring such retransmission sites be physically protected, no fixed repeater sites were installed. Tactical retransmission sites were used by maneuver forces during contingency

operations. NATO used STU-II's and the U.S. STU-III's for secure voice, but as was the case in Bosnia, interoperability problems.

Commercial turnkey services were leased by KFOR and its MNBs as replacements for the tactical networks. The military overlaid the commercial network with secure UHF, VHF, and HF radio networks and embedded appropriate MILSATCOM backbone connectivity to support assured connectivity for key command and control and intelligence needs.

Internet was not only used to share information with non-military elements but for the U.S., it was also a Morale, Welfare, and Recreation (MWR) service that accommodated e-mails to and from home for the soldiers deployed to even some of the most remote sites in MNB(E). U.S. tactical data communications provided NIPRNET (with Internet access) access to almost every U.S. soldier deployed in Kosovo.

KFOR CIS Network

NATO employed a three-tier communications concept for the KFOR deployment where Tier I provided KFOR headquarters connectivity to EAC, Tier II supported KFOR headquarters and connectivity with the MNBs, and Tier III supported the MNBs. The NATO Mobile Communications Module (MCM), a deployable tactical SHF satellite capability, was deployed to provide the initial Tier I connectivity. The ARRC was the initial KFOR headquarters' element and the UK used the 1st UK Signal Brigade to provide the PTARMIGAN tactical network to support the Tier II connectivity. The MNB lead nations deployed their tactical communications capabilities to support the Tier III connectivity that included communications support to those nations assigned to their sectors (e.g., MNB(E) provided support to the Greek, Polish, and Russian base camps). At the outset of the operation, there were PTARMIGAN interfaces established with some of the national tactical systems of the MNBs such as the U.S. MSE and German AUTOKO, and with the NATO IVSN voice network. The IVSN provided voice services to NATO and military headquarters elements such as SHAPE, AFSOUTH, LANDCENT, and the CAOC. Secure VHF radios, UHF TACSAT, HF RATT, and INMARSAT supported the headquarters command and control network. Information systems such as CRONOS, LOCE, CTAPS, Interim CAOC Capability, and ADAMS supported KFOR (ARRC) command and control, intelligence, air operations, and combat

support needs. There were also secure fax, voice (STU-IIBs), and VTC capabilities to support headquarters operations.

NATO had a three-phase plan to commercialize the KFOR communications and information systems. The initial phase of commercialization was to replace the military tactical network supporting the KFOR headquarters elements before the ARRC transferred authority to LANDCENT in October of 1999. Phase Two extended the network to include connectivity to the MNB headquarters and Phase Three was commercialization of the VHF command network. The plan was to lease a VSAT and IDNX/PROMINA backbone network that the prime contractor would install, operate and maintain. Commercial SATCOM and PTK/PTT E1 connectivity would be added as they became available and needed. NATO contracted with SPACELINK to lease the commercial backbone network to replace the tactical systems and SPACELINK, Alcatel, NATO SATCOM, and PTT E1s provided the carrier connectivity. There were also a few line of sight radio links planned to support connectivity.

Phase One, the leased commercial digital backbone network based on commercial SATCOM and IDNX/PROMINA multi-service access platforms, was not fully completed before the transfer of authority to LANDCENT. As a result, it was necessary to deploy a German signal unit to replace PTARMIGAN with AUTOKO/AUTOFU until the commercial coverage could be implemented. Withdraw of the UK signal unit also removed the secure VHF command net and some of the tactical level interfaces with the MNB national systems such as the U.S. MSE. NATO's UHF TACSAT was used to support the command net until Phase Three of commercialization implemented a Kosovo-wide secure VHF radio command net. The VHF command net was to consist of 11 base stations, 10 mobile stations, and about 85 tactical handheld radios with implementation to be completed in the fall of 2000. The VHF repeater sites would cover major towns and supply routes. The radio equipment was to be collocated with KFOR units for power and force protection purposes. Commercialization Phase Two was completed before the April 2000 TOA to EUROCORPS. There were continuous reconfigurations as the KFOR headquarters grew to accommodate new missions such as the elections.

The NATO C3 Agency acquired the NATO CIS supporting KFOR. They also purchased Kosovo-related equipment used by SHAPE ACOS

CIS, the Allied Rapid Reaction Corps G6, AFSOUTH G6, LANDCENT G6, KFOR CIS Control Center (CISCC), and NATO CIS Operating and Supporting Agency (NACOSA). NATO funded and provided CIS services to NATO organizations and KFOR (Main, Rear, COMMZ, APOD) and its multinational brigade headquarters. National Support Elements (NSE) provided their own CIS service; the NSEs were not NATO funded since they were viewed as national responsibilities.



Figure 4. KFOR HQ Pristina SATCOM

The communications systems supporting KFOR operations in June 2000 consisted of: a secure VTC network that connected SHAPE, KFOR Main and Rear, and COMMZ(W); a secure UHF TACSAT command and control command net that linked KFOR, GFSU, APOD, COMMZ, and the MNBs; a secure UHF TACSAT Close Air Support and Air Operations net that linked KFOR AOCC, MNB TACPs, AWACS, ABCCC, and CAOC; INMARSAT terminals with KFOR, GFSU, COMMZ, and the MNBs; and there were Motorola handheld radios and GSM cellular phones. The NATO MCM (Figure 4) supported military command and control connectivity with SHAPE. SPACELINK was managing the backbone digital network supporting the KFOR voice, data, and VTC services.

A voice network, referred to as the Kosovo Private Network (KPN), provided clear voice services to KFOR, the MNB headquarters, GFSU, APOD, COMMZ, CPIC, and other KFOR elements. STU-IIBs were used

to provide secure voice services but there were performance problems using them on the KPN. The KPN was not interfaced with the U.S. TRI-TAC/MSE and Dragon package supporting MNB(E) or the DSN but there was an operator interface with the USAREUR operator in Heidelberg. There were plans to interface Dragon and DSN in the near future. Connectivity to UNMIK was provided through PTK access and there were plans to link the UNMIK and KPN switches. The KPN was interfaced with the NATO IVSN voice network that provided access to NATO, SHAPE, and other users of the IVSN. Kosovo and Macedonian PTT access and international PTT calling were supported as well, including mobile phones and INMARSAT access. There were also limited interfaces with French, UK, and German national military systems.

KFOR was preparing for the implementation of its VHF command net (Phase Three of its commercialization initiative). KFOR was also working with the Kosovo Protection Corps (KPC) and the PTK to establish a UHF radio relay and PABX network for the KPC that would provide handheld and mobile radios and fixed and wireless telephones to link their regional and headquarters operations. The network would use Alcatel and Thomson systems.

There were three independent KFOR data networks. A NATO Secret network (CRONOS) that processed NATO classified data and e-mail and was only accessible by NATO Secret cleared personnel and primarily used by SHAPE, the KFOR command group, the KFOR J2/G2, GFSU, COMMZ(W), COMMZ(S), and MNB headquarters staff. A KFOR Secret Network (KSN) was the primary command data network and processed KFOR Secret data and e-mails. The network was accessible by KFOR personnel who were nationally cleared to the secret level (not all national elements supporting KFOR and the MNBs had direct access to the KSN). The primary users were J1/G1, J3/G3, J4/G4, J5, J6/G6, J8, and J9. There was a KFOR unclassified (Internet) network that provided limited Internet browsing privileges, but e-mail sites such as Hotmail.com were blocked. Network access was provided to SHAPE, KFOR, MNBs (except MNB(E) which provided its own Internet access via NIPRNET), GFSU, CPIC, and COMMZ(W). COMMZ(S) provided its own access to the Internet. As was the case for the ARRC, information systems such as CRONOS (PAIS and JOIS), LOCE, CTAPS, Interim CAOC Capability, and ADAMS continued to be used to support KFOR OPS-INTEL needs. There was also U.S. Joint Broadcast System access for Hunter and Predator video and there were a number of national

intelligence cells (U.S., UK, GE, FR, IT, SP, BE, and Scandinavian) located at Pristina on the KFOR compound.

Turnover of military maintenance and administration personnel was a major challenge for the KFOR J6. There was a plan to use a mix of contractors and civilians to provide continuity for their O/M support activities.

MNB(E)/Task Force Falcon CIS Network

Bosnia experience was a major factor in the successful deployment of communications and information systems to support U.S. forces in Kosovo. The deployed units had CIS capabilities comparable to their home bases and in some cases, they exceeded home base capabilities. Even soldiers at remote hilltop sites had the ability to access voice and data networks, including the ability to exchange e-mails with home. The full range of Defense Information System Network services were available. The deployed units had access to the Defense Switched Network (DSN) voice services, Defense Red Switched Network (DRSN) Secure voice services, the secure and non-secure data networks SIPRNET and NIPRNET, and secure VTC. The MNB(E) tactical operations center had access to the U.S. Global Command and Control System (GCCS) and NATO provided MNB(E) with access to its KPN voice service, the secure data networks CRONOS and KSN, and the intelligence system LOCE.

The 5th Signal Command developed Deployable Automation Support Host (DASH) was used extensively in Kosovo. The DASH included NIPRNET and SIPRNET routers, LANs, modems, VTC, and other information system capabilities. It was used in combination with U.S. Army tactical communications equipment to create light, medium, and heavy deployable CIS packages. The light package supported 60 to 100 subscribers and could be deployed in 24 hours. An AN/TSC-93B TACSAT provided the long haul connectivity for the DASH. The medium and large packages supported a larger number of subscribers and could be deployed in 48 hours. The medium communications configuration consisted of an AN/TSC-85B TACSAT and an AN/TTC-48 tactical switch. The heavy package consisted of an AN/TSC-85B TACSAT, an AN/TTC-39D tactical digital switch, and a multipoint control unit (MCU). The services offered included tactical phones, long locals to a PBX, NIPRNET, SIPRNET, and desktop VTC and a 64 Kb/s path to support

Joint Deployable Intelligence Support System access. An Echelon Above Corps (EAC) Point of Presence (POP) configuration was provided as well, and this package consisted of the DASH plus an AN/TSC-85B TACSAT, an AN/TTC-39D tactical digital switch, MCU, UHF, TROPO, cable, and other communications support capabilities.

The growing demand for tactical data and special capabilities such as real-time UAV video dissemination, VTC, and telemedicine exceeded the capabilities of the military tactical systems. In order to accommodate the growing demands, some innovative and non-standard packaging of mixed military and commercial capabilities became necessary to overcome the limitations of the current tactical systems. The tactical EAC systems suffered similar limitations. Quick response deployable commercial packages were developed. There were several versions of the USAREUR/CECOM commercial Fly Away package (FAP) that accommodated voice and data services. Both used Ku-band commercial satellite dishes (there were 2.4 and 3.7 meter dishes) and transmitters and receivers. The early version used FCC-100 multiplexers with KG-194 link encryption, FXO/FCS LDCLEP cards for STU-IIIs, a MITEL phone switch, cell phones with STU-Q44 sleeves, VTC, and CISCO routers to support NIPRNET and SIPRNET access. KIV-7HS was used to encrypt the SIPRNET links. An enhanced version of the FAP used IDNX 400 multiplexers with KIV-19 link encryption. There were also data packages that contained commercial routers, servers, multiplexers, VTC, and telephone switches. Commercial high-speed multiplexers (HS-MUX) were used to transmit 256Kbs over MSE. Transportable commercial satellite systems were employed and commercial Ku and C-band capacity was leased to provide connectivity. INMARSAT and international cellular capabilities were employed as well.



Figure 5. Communications Strategy

In order to free up the tactical assets for future deployments, the strategy (Figure 5) was to provide a commercial communications package with voice and data services down to the desktop. It was intended to gradually replace the tactical capabilities with a commercial service. USAREUR/5th Signal Command and CECOM developed the Dragon package for this purpose. The Dragon package consisted of a 3.7-meter commercial Ku-band dish and transmitter and receiver. A Promina multiplexer with KIV-19 link encryption was used to integrate the digital pipes supporting voice, data, and DRSN and VTC services. A Lucent Definity PBX provided voice services and CISCO routers, Cabletron smart switch and hubs, and Ethernet LANs were used for NIPRNET and SIPRNET with KIV-19 encryption for the SIPRNET links. The Dragon came in both shelter and rack mounted configurations. The contractor provided the IMO functions.

In addition to the 7th Signal Brigade tactical EAC POP, DISA also provided a POP for access to the DISN and Joint Broadcast System. Reach-back capabilities were also employed by the U.S. Army to provide access to a broader range of voice and information services in the Central Region and the DISA Standardized Tactical Entry Points (STEP) were used to access DISN voice, data, and VTC services. The U.S. Army also used a deployable contingency operations package (CONOPS) that employed a mix of commercial and military tactical capabilities to extend C2 services to a JTF commander. This capability was also used to extend MWR services to remote locations. Leased commercial SATCOM and DSCS were the major long haul carriers.

Echelons Corps and Below (ECB) relied on mobile subscriber equipment (MSE) and the tactical packet network (TPN) for secure voice and data services. Since the MSE/TPN operated at the Secret high level, the network encryption system was used to tunnel the unclassified network (NIPRNET and CUDIN) through the MSE/TPN to provide unclassified e-mail service and Internet access.

The U.S. enabling force that deployed into Kosovo used U.S. Army tactical communications and Fly Away packages (FAP). The Marine element deployed its JTF Enabler package that also used a mix of military tactical and commercial communications and information systems capabilities to support the command and control needs of the deployed commander. For the sustained phase of the operation, the US Army planned to employ its Dragon package, a commercial, contractor-maintained, and operated capability. The Dragon package was to support the communication and information needs of Camp Bondsteel and Camp Montieth, the major US support bases in Kosovo and Camp Able Sentry in Macedonia. While in Kosovo, there was a mix of both tactical systems (Figure 6) and the Dragon capability supporting the base camp needs.



Figure 6. Camp Montieth Communications

There was a tactical EAC POP package at Camp Bondsteel that was linked via the DSCS to the Landstuhl STEP site and to the Funari reach-back via a FAP and COMSAT link. A DISA POP was deployed at Camp Able Sentry and connected to Stuttgart and Heidelberg via the

SPACELINK commercial satellite system. A FAP and COMSAT link supported reach-back services from Camp Able Sentry to Funari. Camp Montieth was linked to the Landstuhl STEP via the DSCS. Commercial satellite connectivity linked the Dragon packages supporting Camps Bondsteel, Montieth, and Able Sentry. There was also a tactical TROPO link (TRC-170) between Bondsteel and Montieth (Figures 7 and 8).



Figure 7. TRC-170 Camp Bondsteel



Figure 8. TRC-170 Camp Montieth

There was a CONOPS package on Camp Bondsteel that could be deployed on notice and be up and running in 2 hours or less providing

DSN, NIPRNET, SIPRNET, and VTC services. Because of the mountainous terrain in Kosovo, an AN/TSC-93 TACSAT was used for this capability and linked the deployed CONOPS package (Figure 9) with TFF at Camp Bondsteel. The CONOPS package also had a SHARC that provided single channel TACSAT and an INMARSAT and FM retransmission capability. The CONOPS package was used to support special deployments such as the U.S. forces sent to Metrovica during the riots and was used for MWR to extend voice, e-mail, and even VTC to soldiers at remote sites such as outpost Eagle's Nest on the Serbian border (Figure 10). Camp Bondsteel was wired with fiber optic cable, requiring careful coordination with the camp contractor Brown and Root and the military engineering units to avoid accidentally digging up the cables.



Figure 9. CONOPS Package



Figure 10. CONOPS Deployment at the Eagle's Nest

In Kosovo, the Dragon system was installed in fixed facilities (Figure 11). The implementation timeline provided for an initial operational capability at Camp Able Sentry and then Bondsteel, followed by Montieth. The tactical systems used to extend communications service to the Russian, Polish, and Greek base camps were to be replaced by extending commercial services to these camps as well. The contractors TAMSCO and EPS under a GSA contract administered by CECOM installed the Dragon and provided O/M for each site and the IMO functions. The 5th Signal Command contracted with ARTEL, Inc. to provide onsite technical representation to monitor the Dragon activities to ensure compliance with the statement of work. There was a 5th Signal Command LNO at Bondsteel to facilitate coordination and help resolve problems. This arrangement created some several challenges for the TFF G6 since the contractors did not report to him, but were under the direction of USAREUR/5th Signal Command and CECOM.



Figure 11. Dragon Package on Camp Bondsteel

A limited commercial cellular capability was also introduced. The IFONE system was installed at Camps Bondsteel and Montieth and the Vitina base camp. IFONE was connected to the Dragon so a cellular user at Bondsteel could call through the Dragon to a user at Montieth as well as talk to users on Bondsteel. The IFONE was not installed at Camp Able Sentry because the Macedonian government had not approved the frequency request. Camp Able Sentry users could, however, call IFONE users through the Dragon. The system covered a 7 to 8 kilometer radius around the base camps. It used a single cell with 32 transceivers and 150 AMPS (U.S. standard cell phones). The AMPS could use STU-Q44 sleeves for secure operation and sleeves were provided for operational use. The system had the option to incorporate a GSM capability as well. For cost reasons, full cell coverage of the MNB(E) sector was not possible. Like the Dragon, contractors maintained the IFONE system. In the final analysis, the conversion to commercial services essentially drove the Army to set up the equivalent of a commercial telephone company and ISP to run the fixed-base telecommunications and information services supporting MNB(E).

The DISN STEP access facilities used the DSCS satellite to accommodate connectivity with deployed tactical GMF terminals. At the outset of the air war, there were only three active STEP sites (Landstuhl and Ramstein, Germany and Croughton, England) and none were fully equipped with its pre-provisioned DISN services package. Hence, there was an urgent need to complete the upgrades to these sites. Furthermore, because of the increased demand for service, including possible deployment into Kosovo, there was an added demand to accelerate the activation of the STEP capability at Lago Di Patria, Italy as well—a significant challenge that the Joint Staff, EUCOM, DISA, and the Army successfully overcame. The Army Fly Away packages were used to accommodate an early reach-back capability to the central region. The DISA Commercial Satellite Communications Initiative (CSCI) provided INTELSAT 601 commercial transponders that supported the DISA POP, FAP, and Dragon connectivity needs. The Newsky and Orion commercial satellites were used as well to support FAP and MWR connectivity. AAFES contracted with Sprint to provide commercial pay telephone service to Camps Bondsteel, Montieth, and Able Sentry so that military personnel could use calling cards to make personal calls. Calling cards could be purchased from the PX. This service used the Orion satellite for connectivity to the PTT entry point.

Managing the mix of U.S. commercial and military systems was a challenge for the TFF G6 as well as the contractors and signal units supporting the deployment. Because of the number of different players and a lack of clear definitions of the relationships of the organization elements, the TFF signal unit command and control relationship was complicated and confusing. Not only were there challenges dealing with two major contractors maintaining the Dragon and IFONE networks which did not report directly to the TFF G6, the units supporting TFF came from a variety of signal units and the command relationships were never formally established with them. The two biggest signal units were the 121st Signal Battalion and the 7th Signal Brigade. The 121st Signal Battalion was the division signal battalion and as such was responsible for the U.S. ECB assets such as the MSE network, the TFF G6 and the general health of the overall communications and information networks supporting MNB(E)/TFF, including the multinational units assigned. The 7th Signal Brigade provided the signal units responsible for the systems supporting EAC services and the TACSAT assets and they tended to report to and take their tasking from higher headquarters

in the rear area. The TFF G6 also had to coordinate activities with the multinational units assigned to MNB(E) and with KFOR J6, including frequency management activities and the KFOR services at MNB(E) such as the data networks CRONOS and KSN. The TFF G6 also had to coordinate with DISA-EUR. A DISA-EUR LNO at TFF would have been helpful. The effectiveness of the TFF relationships among the various players became very personality dependent and there was a need to formalize the command relationships among the military and contractor elements.

Providing and managing communications and information systems support on a base camp environment such as Bondsteel was more similar to a DOIM operation than a tactical signal battalion's mission. Units needed to be supported down to the company level once the assets were in place and there were units such as the Red Cross and MWR that required support but did not have equipment or signal personnel. Additionally, TOEs did not provide units with an adequate number of SINCGARS radios. Units such as civil affairs and PSYOP showed up without desktop computers and the TFF G6 had to provide them. Rotation of commanders, units, and other support personnel resulted in constant changes in office configurations, requiring telephone and computer reconfigurations to accommodate the changes. These activities placed additional demands on an already overcommitted TFF G6 staff. It was felt that communications and information systems support similar to a garrison environment might have been appropriate for base camps such as Camps Bondsteel and Montieth.

The success of the communications support to TFF was a team effort on the part of the many dedicated and professional communications and information system participants in the European theater. COL Melita McCully, U.S. Army, commander 7th Signal Brigade, was responsible for U.S. EAC communications and information systems planning, implementation, and operations in Kosovo and the Former Republic of Macedonia. She and her team of dedicated and well-trained communicators, along with elements of the 121st Signal Battalion (supported by the 440th and 44th Signal Battalion) and 22nd Signal Brigade, served to provide secure, responsive, and reliable voice, message, data, and VTC services to the forward deployed forces, including multinational units assigned to MNB(E). There were numerous other organizations such as 1st ID G6, V Corps G6, 5th Signal Command, USAREUR, EUCOM J6, and DISA-EUR whose military,

civilian, and contractor personnel also made significant contributions to the success of the operation.

The tactical network was monitored and managed at multiple levels—system control forward at Camp Bondsteel, 7th Signal Brigade network control center, USAREUR/5th Signal Command network operations center, DISA-EUR network operations center, and EUCOM Joint Communications Operations Cell. DISA-EUR and the Computer Emergency Response Team (EURCERT) monitored and assessed all potential network intrusion attempts, outages, and degradations. EURCERT consolidated all theater incidents and assessments and provided daily and weekly reports to EUCOM and the component commands. USAREUR/5th Signal Command had a regional CERT that proactively monitored the networks for intrusion attempts and abuses. Joint Intrusion Detection Systems were installed at all STEP sites to monitor for possible intrusions. Assessment teams were also periodically sent into Kosovo to evaluate communications and information systems vulnerabilities.

In Kosovo, the 7th Signal Brigade, the 121st Signal Battalion, and 22nd Signal Brigade communicators set new performance standards for meeting the expectations for reliable, high quality telecommunications service. At the 7th Signal Brigade headquarters in Mannheim, Germany, the brigade established an outstanding training program, referred to as the Voice of Freedom University, that focused on developing leadership, technical and interpersonal skills. Courses covered a wide range of subjects from habits of highly effective people to technical skill development offered by the data, cable, DGM, TROPO, and TASAT university elements. This initiative has had tremendous benefits in the Kosovo operation—well trained, dedicated, and can-do soldiers, NCOs, and officers.

The 7th Signal Brigade's EAC communications aided the 121st Signal Battalion, commanded by LTC Kokinda, U.S. Army, and his team to establish a robust tactical communications network that provided communications and information services to Camps Bondsteel, Montieth, and Able Sentry. They extended connectivity and services to the Russian (Figure 12), Polish (Figure 13) and Greek base camps assigned to Task Force Falcon, as well as other U.S. forces deployed at base camps such as the 1-187 IN at Vitina (Figure 14).



Figure 12. U.S. Communications at Russian Compound in Kamenica



Figure 13. U.S. Communications at Polish Camp White Eagle



Figure 14. U.S. Communications at Vitina Base Camp

While on a visit to the U.S. communications facility supporting the Polish Camp White Eagle, I was able to visit a SOF and MI unit collocated with the 121st Signal Battalion team. The SOF and MI units had their own communications as well as DSN, SIPRNET, and NIPRNET access. I was given a tour of the SOF operations center that had a tactical communications to their safe house and units on patrol, including line of sight and satellite communications connectivity. The U.S. communications support to the Polish site and its connectivity to TFF consisted of a MSE single phone and NIPRNET access (without Internet access) for sending SITREPs and other command and control related messages. The U.S. MI team provided intelligence support to the Polish TOC. A MI team was collocated with the Russians and provided them intelligence support as well.

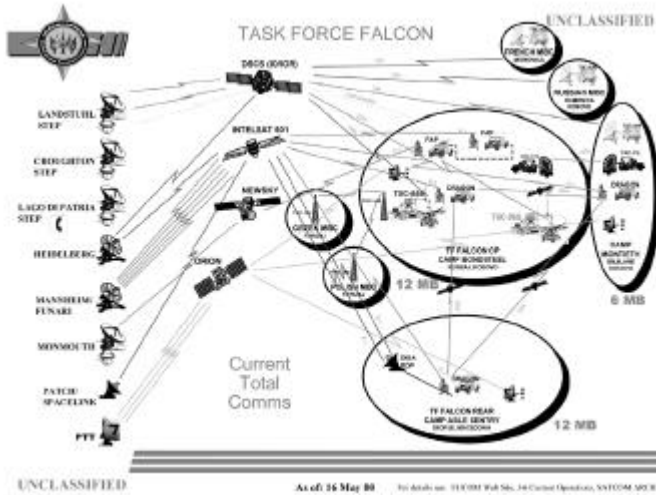

Figure 15. KFOR 1B Network

By June of 2000, the tactical capabilities that supported Camps Bondsteel, Montieth, and Able Sentry were converted to the commercial Dragon package, except for an overlay tactical network (Figure 15). The network continued to provide a command and control capability for the TFF commander that was owned and operated by the U.S. military. MAJ Lin Crawford, U.S. Army, 7th Signal Brigade, was responsible for the capability referred to as Charlie Rock, an EAC POP that provided 12 DTGs, 48 TAC phones, 21 DSN, NIPRNET, SIPRNET, and DRSN service. VTC was extended from the Dragon. The Rock was linked to the Landstuhl STEP and Heidelberg reach-back. There were also tactical links to Camps Montieth and Able Sentry, the Russian, Polish, and Greek base camps, and U.S. forces at Klokot and Vitina. Major Crawford's team also supported the CONOPS package deployments.

U.S. intelligence communications connectivity was handled through EUCOM J2, DISA-EUR, USAREUR DCSINT, 66th MI, and agencies (such as DIA for JWICS connectivity) of the National Intelligence Support Team that supported Task Force Falcon at Camp Bondsteel and the U.S. National Intelligence Cell that supported KFOR headquarters at Pristina. Satellite connectivity was provided by the military DSCS (IO/IO) and the commercial satellite systems of INTEL SAT, NEWSKY, and Orion. Commercial Ku-band was used

extensively in the Balkans supporting both Bosnia and Kosovo operations. Besides being expensive, the Ku-band was at its limits in terms of available capacity for military use. USAREUR/5th Signal Command planned to transition the Kosovo commercial SATCOM architecture to the less expensive C-band in order to save money and to free up the Ku-band for other military uses.

The mountainous terrain of Kosovo affected the performance of the line of sight FM radios such as SINCGARS. There were numerous dead spots throughout the sector, no fixed retransmission sites, and only had a few deployable retransmission capabilities, which took an hour or so to set up for contingency operations. TACSATs were some of the most reliable radios and they were used as backups when units deployed to FM dead spots but even here there were problems. INMARSAT was used as a backup capability for deployed units such as the tactical PSYOP teams. Interference problems were experienced while operating in the single channel mode. The 1st AD was planning to move to frequency hopping and a 5th Signal Command assessment team was starting to look at possible retransmission site options to improve coverage of secure communications throughout the sector.

From the outset of the operation, units purchased commercial handheld radios for the Kosovo mission. The task force never authorized use of these radios, but almost everyone had one and this created an OPSEC problem that had to be carefully managed. There were secure radios such as the PRC-127 and 139 that would have been a better solution. The *TalkAbout* radios were cheap, easy to use, and met most communications needs. The XTS-3000 secure handheld radio was being used by some elements and the TFF G6 recommended approval of their more general use.

Large volumes of information from many different sources fed the TFF operation daily. There was no one organizational element responsible for reviewing, cataloging, and posting information coming into TFF and this made it difficult for members of the task force and others to find the key elements needed to inform and support analysis and the command and control decisionmaking process. It was also difficult to find out what types of information were actually available and where. The large appetite for information from both those within and outside of TFF operations generated numerous RFIs and e-mails with large attachments that placed unnecessary demands on the data networks

and often contributed to slowing down the overall throughput, especially during crisis periods. There was also nobody responsible for managing the information process, including sharing information among multinational partners, KFOR, and non-military players, such as UNMIK and NGOs. A classified TFF Web site was established on SIPRNET to facilitate the sharing of critical information in a timely manner with authorized U.S.-only users, but sharing with KFOR, the other MNBs, UNMIK, and NGOs continued to be problematic. There was a need for a G-level information management office to address the needs of the task force operating in a multinational, multi-agency, and civil-military peace operations environment.

The MNB(E) LNO at KFOR headquarters needed better secure voice, data, and VTC communications connectivity with TFF. He did not have U.S. DSN or NIPRNET and SIPRNET access. He only had KFOR-provided voice and data services. The lack of U.S. secure connectivity required him to make weekly visits to TFF headquarters to put his U.S. briefing together for COMKFOR. He provided COMKFOR with a weekly update of TFF activities and status reports on TFF special events and operations when they occurred. As the TFF commander's representative on the ground at KFOR, there was a need to provide him better communications to keep him more adequately informed of TFF activities so that he could effectively respond to the needs of both COMKFOR and the commander of MNB(E).

Interoperability and communications with KFOR and non-military participants, such as UNMIK and NGOs, were problematic. The voice and data networks of MNB(E) were not interconnected with those of KFOR, the other MNBs, and UNMIK. KFOR extended voice and data services to MNB(E) headquarters by providing some KPN phones and CRONOS and KSN workstations in the TOC area. Secure voice interoperability between the NATO STU-IIB and U.S. STU-III A continued to be a problem—U.S. units needed to deploy with the NATO key. There was no voice network interface with UNMIK police, the PTK, or NGOs. The communications services extended to the multinational units supporting MNB(E) differed and were limited to voice (MSE) and unclassified data (NIPRNET—some had Internet access and others did not, but no Web surfing was allowed). At a minimum, the multinational units had voice and e-mail for sending SITREPS and other command and control information to TFF

headquarters elements. Collocated U.S. LNOs (intelligence support teams) were used to share appropriate RELKFOR classified information.

There were problems communicating in the secure mode (due to incompatible cryptography) with the radios of the multinational units assigned to MNB(E) and with those of other MNB units, especially those that shared the boundary with MNB(E). SINCGARS had to operate in the single frequency, plain text mode to communicate with other multinational units—another OPSEC challenge. For example, during cordon and search operations in the MNB(E) sector, radios were found that were tuned to KFOR and MNB(E) frequencies. The Russians were the only unit which MNB(E) was not able to communicate with at all. Unlike the other nations who participated in interoperability testing, the Russians would not provide TFF G6 with any information on their communications assets. The LCE(SOCCE) unit provided an RTO with a SINCGARS radio for the 13th Tactical Group operations center when operationally required.

A Dragon interface with the PTK was being considered by 5th Signal Command as a way to provide access to UNMIK, NGOs, and others having access to the PTK. The *Dragon* was being interfaced with the KPN to improve the ability to communicate with KFOR and the other MNB headquarters and remove the need for KPN phones in MNB(E) headquarters. The use of a common COMSEC key was also being discussed with SHAPE as a way to improve tactical communications.

Commercialization of U.S. communications encountered a number of challenges ranging from onsite coordination to delivery delays to base construction delays. There were issues related to coordination of trenching efforts that would allow signal cables to be buried without duplicating work efforts and avoid accidental cutting of buried cable, which did happen. There were delays in power installation and site preparation. Deployed forces were constantly moving personnel and office functions from building to building without proper coordination with the signal units, and this impacted the ability to establish a communications and information systems baseline that in turn delayed the signal units' ability to transition to sustained operations. The TFF G6 felt that many of the commercialization coordination and implementation issues could have been avoided by employing a full-time commercialization planning cell that deployed forward during the

commercialization implementation phase to facilitate coordination and timely resolution of issues.

26th Marine Expeditionary Unit (MEU) Communications

From April 28 through June 3, 1999, the 26th MEU was engaged in supporting JTF Shining Hope in Albania. On June 4, 1999, the MEU was ordered to turn over the refugee camp security mission to the U.S. Air Force and proceed to Macedonia to participate in the Kosovo operation. Participation began on June 10, 1999 with the offloading of the Marine ground combat elements at Thessaloniki, Greece and then traveled through Greece to Macedonia and the staging area on the border with Kosovo at Brazda. On June 14, they entered Kosovo from Macedonia as part of the U.S.-led enabling force and on June 15 they took over their tactical area of responsibility in Gnjilane, replacing French and British forces that had moved on to their respective sectors of MNB(N) and MNB(C). The 26th MEU set up their forward operating base (FOB) on a hilltop overlooking the main city of Gnjilane. The mission was to secure lines of communication, conduct security operations, and enforce the MTA. There were numerous gaps and ambiguities in the mission guidance and information provided the MEU, especially regarding exit criteria. Neither an end state nor a transition plan was ever provided to the MEU. The 26th MEU completed its mission and transferred authority to the U.S. Army 1-26 Infantry on July 10, 1999.

The JTF Enabler package, INMARSAT, GSM Cellular phones, and UHF TACSAT and VHF and HF radios provided communications support to the deployed 26th MEU commander and his forces. Convoy communications relied on UHF-TACSAT and tactical VHF and HF radios and GSM cell phones. Air operations communications with the helicopters and the FAC, NAEW, and ABCCC relied on UHF and VHF radio. The JTF Enabler was used to support the headquarters. Within 6 hours of arrival outside of Gnjilane SIPRNET, NIPRNET, and DSN access were operational and within 12 hours the installation was completed providing SIPRNET, NIPRNET, DSN, AUTODIN, DTG, CRONOS/LOCE, JDISS, and VTC services to the FOB. Access to the Defense Information Systems Network was provided by a TSC-93B link over the DSCS IOR

satellite to the Croughton, England STEP site. The tactical network consisted of a UHF net, six VHF nets, and two TACSAT nets. The primary command net was VHF and because of the mountainous terrain, performance was a problem and a retransmission site was needed to provide reliable coverage to deployed units. The retransmission site used an MRC-145 (two vehicle-mounted high-power VHF radios). In order to further ensure reliable communications performance, a contact team was sent out daily to units to closely supervise their communications assets, resupply batteries, and solve equipment and communications issues—the biggest threat to effective communications was the user.

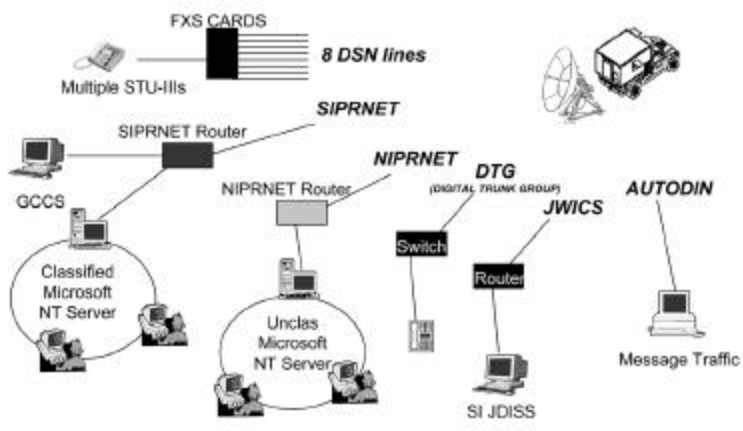

Figure 16. JTF Enabler

The JTF Enabler package (Figure 16) combined commercial and military tactical capabilities to extend communications and information services to the MEU commander and his headquarter's operation. The package consisted of a TSC-93B tactical satellite terminal, FCC-100 multiplexer, KG-194 encryption, SB-3614 and SB-3865 tactical switchboards for DSN and commercial access, FXS card to accommodate STU-IIIs, CISCO Routers, SMC Hubs, classified (SIPRNET), and unclassified (NIPRNET) LANs running Banyan Vines 6.3, Compaq Proliant servers, VTC suite, Microsoft NT Toshiba laptops, Sun Spark 20s for GCCS and JDISS, CRONOS/LOCE with NIDTS access, AUTODIN, and TQG-803 generators. The 10BaseT network connected to the Compaq *Proliant* servers that were housed in reinforced cases running Windows NT Server 4.0. The network could accommodate access as far away as a

quarter mile from the headquarters. There was heavy reliance on other commercial services such as cell phones, INMARSAT, and IRIDIUM.

The 26th MEU deployment provided reliable communications to the commander and his forces, despite numerous obstacles. OPSEC violations on NIPRNET needed to be carefully managed. It was necessary to ensure SIPRNET availability in order to avoid improper use of NIPRNET during stress periods. Fans were needed at times to keep the notebooks cool. Dust and frequent movements took their toll on the notebooks as well. Power issues tended to pose big challenges during the 12 hours following a headquarters move. The UPS systems were key to helping during this period. Viruses from outside sources were a problem to be dealt with and virus protection updates were done weekly through the DISN anti-virus site license.

CHAPTER XXV

Kosovo Communications Commercialization: USAREUR Experiences

Danny Johnson and Paul Meaker

Senior signal leaders and planners from U.S. Army Europe's (USAREUR's), Office of the Deputy Chief of Staff, Information Management (ODCSIM), V Corps' G-6, the 1st Infantry Division, 7th Signal Brigade, 5th Signal Command, 22nd Signal Brigade, and the 29th Area Support Group (ASG), participated in a series of planning meetings during the April and May 1999 timeframe to develop the overall KFOR communications architecture.

Communications planners and technical experts, many of whom had experience supporting the Stabilization Force (SFOR) in Bosnia-Herzegovina (B-H), applied that experience and the lessons learned to the challenges of Kosovo. Planning examined all aspects of Operation Joint Guardian (OJG) to include communications requirements:

- In the Central Region Sea Port of Embarkation (SPOE) at Bremerhaven, Aerial Port of Entry (APOE) at Ramstein, and DPC at Rhine Ordnance Barracks;
- In support of Sea Port of Debarkation (SPOD) operations in Thessalonike, Greece;
- For the initial entry force;
- Inside Kosovo in support of base camps, tactical units, and Task Force (TF) Falcon headquarters; and
- In Macedonia for the Intermediate Staging Base (ISB) and TF Falcon (Rear) at Camp Able Sentry (CAS).

As a result of this detailed planning, there were no communications-related “show stoppers” during the transition from Operation Allied Force (OAF) and Task Force (TF) Hawk to OJG and TF Falcon.

Background

In early March 1999, Camp Commanche (B-H) was commercialized, freeing up a Fly Away Package (FAP), which had been deployed since early 1998 providing communication support to the USAREUR, Office of the Deputy Chief of Staff, Logistics (DCSLOG). On March 25th, 5th Signal Command was given direction to re-deploy the package to support CAS, Macedonia. It was shipped on 3 April, and was passing traffic by 5 April. The insertion of this package marked the first use of commercial communications to the Kosovo operation, by the U.S. military.

In conjunction with the FAP deployment, the 26th Marine Expeditionary Unit (MEU) deployed with its tactical satellite system, and the 7th Signal Brigade supported the U.S. Army Southern European Task Force (SETAF) with a single channel tactical package (tactical satellite and small switch) as it had in previous operations. Meanwhile, the 29th ASG planned communications support for the SPOD operations at Thessalonike, Greece, which the 7th Signal Brigade was able to satisfy with a medium tactical communications package.

Within the next 45 days, a second Fly Away Package was assembled and shipped to Albania in support of OAF and TF Hawk. A third Fly Away Package was called forward by the U.S. Army Communications and Electronics Command (CECOM) to support the increased logistics requirement of both OAF and TF Hawk. Upon completion of OAF, both packages were deinstalled and moved forward to support TF Falcon at Camp Bondsteel augmenting both the tactical network and the infant Dragon program.

Still building from the lessons learned in B-H, communications support for the multinational base camps were examined. Kosovo did not pose the challenges experienced in B-H, where there was a requirement for a separate network for the specific purpose of allowing the multinational task forces in the U.S. sector to communicate with their higher headquarters, Task Force Eagle U.S. Commander. This Releasable Stabilization Forces (RELSFOR) network, or commonly known as the Mercury Network, allowed the U.S. Task Force Eagle Commander to

pass classified information to his multinational Commanders. This network consisted of a separate secure telephone system to include different telephone instruments and an enclosed separate secure data system. Initial plans for Kosovo called for a similar system, but to date it has not been implemented.

USAREUR supported KFOR Multinational Polish, Ukrainians, and the United Arab Emirates (UAE) commands with Dragon Packages with the Greek and Russian commands programmed for future inclusion. The Ukrainians and UAE commands were co-located at Camp Bondsteel utilizing its Dragon Package. The Polish Command received services from a mini Dragon package, and the Greek Command was provided with a similar package. The Russian camp was scheduled for commercialization in early 2001. Commanders of the multinational forces received only a limited amount of communications services (e.g., no data or e-mail, just a non-secure telephone).

Transition to Commercial Communications

The decision to transition to commercial communications as quickly as possible was based on the lessons learned from SFOR and resulted in first class communications support to TF Falcon commanders and soldiers.

Early in the operation, before command of TF Falcon transitioned from BG Craddock to BG Petersen in August 1999, several key decisions were made that were related directly to the lessons learned in B-H and to the fundamental assumption that KFOR would be a 3- to 5-year operation.

One of those decisions was to think big with communications and to put in a network that could grow with the demand. This guidance recognized that the communication requirements would grow as KFOR's operations and base camps matured. This guidance also recognized that economically, an incremental approach would have to be followed for satellite bandwidth procurement, but a *think big* concept could be followed in the design of the actual communications facilities built. The Dragon systems were therefore engineered with such features as dynamic bandwidth management, redundancy in data processing capability, modular growth compatible voice switches, and rack mounted encryption devices for extending classified data services to the customer.

Commercial Communication Implementation Timeline

The commercialization of communications support suffered delays that stretched the original timeline. Requirements continued to grow beyond the original plan during the first 6 months of the operation, especially at Camp Bondsteel, although the architecture and systems were robust enough to handle the increase. The original design had sufficient bandwidth to accommodate long distance voice trunking for every major customer at Camp Bondsteel. Additionally, the design ensured sufficient capacity to support the Morale, Welfare and Recreation (MWR), Army and Air Force Exchange Service (AAFES) and hospital requirements, as well as all the other outside agencies that ultimately became both tenants at Bondsteel and bandwidth consumers with their own unique communications requirements. Eight months after starting the commercialization effort, virtually all communications had been moved to the Dragon packages with only a small tactical network remaining.

Fly Away Packages

Signal units with tactical communications deployed into Kosovo with the initial forces in June and July 1999. They deployed with their organic Tables of Organization and Equipment (TO&E) capabilities and with FAPs designed to enhance those TO&E capabilities. In later months, as the base camps grew and the operating tempo stabilized, Dragon commercial communications packages were phased in and eventually replaced the tactical communications systems.

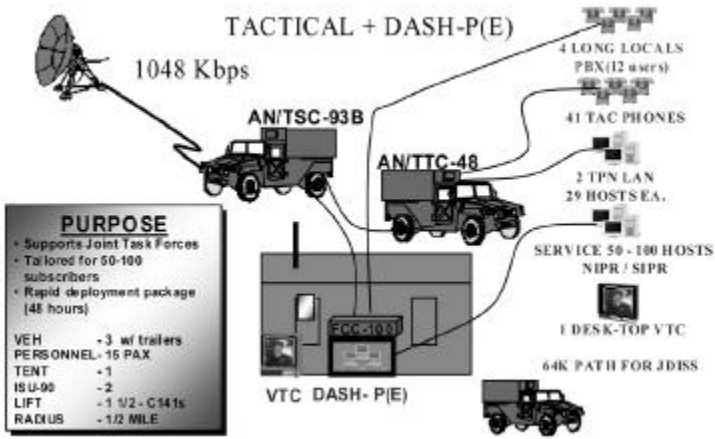

Figure 1. Medium Tactical Package

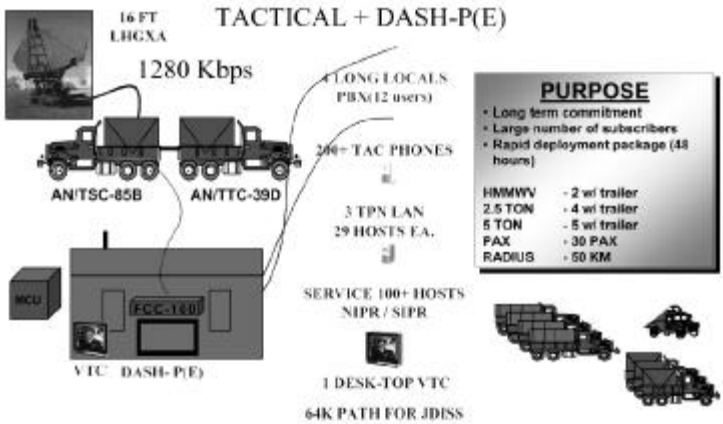

Figure 2. Heavy Tactical Package

The FAP package previously deployed to Albania was shifted to Camp Bondsteel in support of Task Force Falcon. The FAP at CAS had been in place since April 1999. Each FAP consisted of off-the-shelf commercial equipment designed to increase the throughput of the 7th Signal Brigade's tactical echelons above corps (EAC) communication systems providing reach back to the Central Region. The FAPs were uploaded and deployed in high mobility multipurpose-wheeled vehicles (HMMWVs), but once in the Area of Operation (AO) they were installed

and operated from inside available structures. The packages handle substantial amounts of both nonsecure Internet protocol router network (NIPRNET), secure Internet protocol router network (SIPRNET) data, video teleconferencing, and DSN voice. Considered as augmentation to tactical communications, contractor personnel operate the packages.

Although the FAPs provided an immediate increase of approximately 200 percent in the capacity of the TO&E communications systems, TF Falcon's communications requirements soon outgrew even this capacity as the base camps matured into semi-permanent cities providing a wide range of services, most of which generated communications requirements.

Commercialization using Dragon packages was inevitable and had been planned for from the onset of the mission. When the Dragon packages were deployed and brought online, the TF Falcon FAPs were shut down and retrograded to the Central Region for refurbishing and preparation for the next contingency mission.

Dragon Packages

Dragon packages were designed by 5th Signal Command, and developed by CECOM. The packages are highly effective in providing reliable, high-capacity commercial communications, offering a full spectrum of capabilities including SIPRNET, NIPRNET, and voice, as well as special circuits for VTC, intelligence systems, etc. The Dragon packages should be considered sustainment communications support.

Each Dragon package contains various switches, routers, and servers to handle roughly 1,200 Defense Switched Network (DSN) telephone lines, 150 plus SIPRNET terminals, 1,500 plus NIPRNET terminals, and VTCs, etc. All equipment is rack-mounted and deployed in shelter vans. However, upon arrival in Kosovo and Macedonia, the packages were installed in fixed structures. Essentially, the packages are mobile commercial systems that provide communications capabilities similar to those found at military installations throughout the Central Region.

CAPABILITIES

➤ 1200 DSN
➤ 150+ SIPR

➤ 1500+ NIPR
➤ Special Circuits



<p>Rack A</p> <ul style="list-style-type: none"> •KIV 7s •Cisco Router •UPSI UPS 	<p>Rack B</p> <ul style="list-style-type: none"> •3 HP Servers •UPSI UPS 	<p>Rack C</p> <ul style="list-style-type: none"> •Ethernet Switch •UPSI UPS 	<p>Rack D</p> <ul style="list-style-type: none"> •3 HP Servers •UPSI UPS
<p>Rack E</p> <ul style="list-style-type: none"> •Cache Engine •Cisco Router •Cisco Terminal Server •Ethernet Switch •UPSI UPS 	<p>Rack F</p> <ul style="list-style-type: none"> •Pairgain Chassis •IES •UPSI UPS 	<p>Rack G</p> <ul style="list-style-type: none"> •IDNX Expansion Shelf •UPSI UPS 	<p>Rack H</p> <ul style="list-style-type: none"> •Modem Switch •KIV-19 •UPSI UPS

Figure 3. Rack-Mounted Dragon Package



Figure 4. Trailer-Mounted Antenna

Dragon packages were deployed to CAS, Camp Bondsteel, and Camp Montieth along with contractor personnel to operate and to maintain

them. In addition, the contractor teams provided additional user services such as:

- 24/7—customer help desk;
- E-mail administration;
- Network management;
- End-user network configuration;
- Voice switching;
- Engineering and integration; and
- Add/remove/relocate phones.

USAREUR now owns the Dragon packages. When the KFOR mission ends, the packages will re-deploy to the Central Region and be refurbished by contractors in preparation for the next contingency operation. This approach was taken to allow today's Dragon packages to become tomorrow's Fly Away packages.

Data Packages

Data packages are off-the-shelf commercial equipment components—routers, servers, etc.—used in support of NIPRNET and SIPRNET, e-mail, VTC, and long locals. Such packages enhance the capacity of tactical systems where switches are normally limited to 64 kilobits per second (kbps). Using data packages, communication signals are pulled directly from the satellite and bypass the switches. This effectively increases the throughput of the existing tactical network.

Based on experience acquired while supporting TF Hawk in Albania, the 7th Signal Brigade actively promoted the use of data packages as an effective means to boost the performance of the TF Falcon tactical network. As a result, the initial TF Falcon tactical network was able to handle more of the growing communications requirements (NIPRNET, SIPRNET, VTC, etc.). The 7th Signal Brigade initially fielded eight data packages. Later, it procured and fielded 20 more. Also, V Corps' 22nd Signal Brigade procured and installed an additional four packages.

Commercialization

Despite implementation delays, the commercialization of communications support for TF Falcon represented a tremendous achievement accomplished in record time. Commercial communications planning really did not begin until a few weeks before TF Falcon deployed in June 1999. Tactical communications were planned during OAF (April—May 1999), and commercial communications planning followed in May—June, just before the air war ended. ODCSIM and the 5th Signal Command led the planning for commercial communications and worked closely with CECOM, which would execute the program. As a result, when tactical communications deployed into Kosovo with TF Falcon in June, key decisions and plans for replacing those communications with commercial packages already were well underway.

Communications commercialization in Kosovo began in July and according to the plan, was to be completed by October. This was a highly ambitious plan and assumed no significant delays in facilities preparations, vendor deliveries to CECOM, deployment schedules, etc. There were, however, several delays, many of which were outside of the ODCSIM's and the 5th Signal Command's control. Accordingly, the estimated completion date shifted to November, then to Christmas, and finally, to February 2000, when the initial effort was completed. Although some equipment deliveries from CECOM fell behind schedule, many of the milestones slipped because they were dependent on construction work - power installation, site preparation, etc. In point of fact, construction requirements simply outpaced available capabilities, funds, and space, as Camp Bondsteel grew larger than anyone had anticipated.

The main factor in project slippage was the inability of the deployed forces to settle in the newly constructed camps. Personnel and office functions were moved from building to building, with no prior coordination being performed at the signal level. Work efforts such as trenching were not combined with the efforts for signal cable burying, which resulted in duplicate work efforts. The camp construction planners ignored coordination efforts by the signal community. Construction crews often destroyed work accomplished by signal installers. The inability to establish a baseline of communication services never allowed the Signal implementors to move into a sustainment operation.

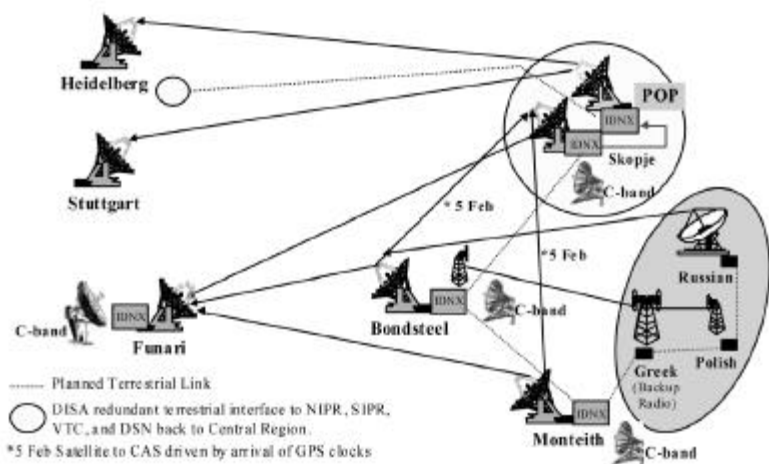

Figure 5. Satellite Architecture in Support of Commercial Communications

Communications Support in Contingency Operations

Limitations in tactical communications made the rapid introduction of commercial communications essential for OJG. In general, tactical communications systems cannot handle a lot of today's data requirements. However, digital requirements for TF Falcon now represent 60 to 70 percent of the total system traffic. Tactical communications simply cannot put out the bandwidth, nor can tactical satellites handle the bandwidth. On the terminating end, the Standard Tactical Entry Point (STEP) sites that integrate all the signals into the mainstream communications system have limited capacity as well.

When TF Hawk deployed to Albania in April 1999, it deployed with tactical communications capabilities. In addition, the TF wanted every communications capability available in the Central Region (NIPRNET, SIPRNET, VTC, etc.). That also was the expectation with TF Falcon. Accordingly, USAREUR went into Kosovo knowing that the deploying units would expect the communications capabilities normally available to decisionmakers and staffs in a garrison environment. That then became the requirement, and it drove communications planners initially to use FAPs, and then full commercialization with the Dragon packages as soon as possible.

Based on USAREUR's experiences in the Balkans to date, the reality is that future contingency and low-intensity military operations likely will require communications support consistent to that found in a garrison environment.

Signal Corps Force Structure Implications

The Balkans represent an important testbed for many support concepts and functional areas, one of the most important being communications. In both B-H and Kosovo, USAREUR is using, adapting, and testing commercial communications solutions that could have significant implications on Force XXI initiatives.

Although Force XXI is focused on tactical communications systems, its concepts clearly will have to incorporate and leverage rapidly evolving commercial communications capabilities and solutions. Open questions are: how will tactical systems handle the growing data requirements; what are the best ways to leverage commercial communications in various operational environments (low- to high-intensity conflict); and if commercial communications solutions are applied, what is the prudent offset in military manpower?

Communication support concepts and solutions stemming from TF Falcon offer important lessons having force structure implications. Force XXI should incorporate those lessons, and should address fully how commercial communications capabilities can be best used, recognizing that they often will be a significant part of the solution.

Defense Information Systems Agency Support

DISA's processes and support are geared to fixed-base, garrison requirements, not to communications support for fast-paced contingency operations. SFOR and KFOR have demonstrated that, not only with regard to acquiring additional bandwidth, but also in the way in which the KU band is managed.

Consequently, USAREUR has invested in satellite dishes and equipment to use a commercial band, the C band, as an alternative to the DISA-managed KU band. Initially viewed as a backup system, USAREUR now is moving to make it TF Falcon's primary system.

Originally, USAREUR requested that DISA coordinate with a commercial vendor, but the proposed solution was unsatisfactory because it did not ensure that TF Falcon would have continuous communications support. For example, the required bandwidth would not be available during the 2000 Olympics in September 2000.

Also, DISA is constrained to only certain commercial alternatives. Consequently, the proposed solutions are not always optimal with regard to USAREUR's contingency needs. However, USAREUR is not so constrained. Of course, by going directly to satellite vendors, USAREUR does lose DISA's services which must be duplicated. Still, USAREUR is able to acquire the needed communications support both faster and at reduced prices.

Conclusion

Without question, the communications planning and execution for TF Falcon was highly successful during the first year of OJG. Based on this success, the ODOSIM should ensure that the planning steps and processes used in support of TF Hawk and TF Falcon are incorporated into the USAREUR and 5th Signal Command SOPs and are replicated during future contingency operations.

CHAPTER XXVI

Field Experience

Larry Wentz

The U.S. military were very accommodating during my visit to Kosovo and encouraged me to accompany them on a number of trips off Camp Bondsteel. These trips provided a unique opportunity to observe and gain insights into how our forces support peace operations. The following are excerpts from notes taken while on patrol with U.S. Civil Affairs and PSYOP teams in the MNB(E) sector of the operation.

Gnjilane

My first excursion outside of Camp Bondsteel was to a weekly UNMIK-sponsored meeting between KFOR/MNB(E) officers and UNMIK officials held in Gnjilane. At this particular meeting, the participants discussed regional and local issues and incidents, including UNMIK-KFOR communications, UNMIK police activities, and local construction of war memorials.

My first trip outside the wire, just a couple of days after having arrived at Camp Bondsteel, was with LTC Beard and First Sergeant Richard Woods, U.S. Army, to an UNMIK four-pillar meeting in Gnjilane. The meeting was my first encounter with UNMIK and was a most interesting and educating experience to kick off my stay in Kosovo. The UNMIK four-pillar meeting occurred every Monday at 7 p.m., lasted about an hour, and was held in the conference room of the UNMIK regional administrator in Gnjilane. We traveled from Camp Bondsteel to Gnjilane in two up-armor Humvees. It was necessary to wear a flack vest and helmet while riding in the Humvee. The drive took over an hour on a busy, potholed road known as Route Stag. The UNMIK offices were in an office building in the center of Gnjilane. Once inside the building, the military participants removed their flack vests and helmets, but wore sidearms. Everyone else was unarmed and in civilian clothes,

except for the UNMIK police officer. U.S. military guards were stationed outside the conference room and in front of the building. Some of the U.S. military attending the meeting had Motorola *TalkAbouts* that were used for communicating with soldiers outside the conference room and on the street in front of the UNMIK building.

The meeting attendees consisted of the UNMIK regional administrator and his deputy, KFOR (Legal), UNMIK police, Task Force Falcon (COL Anderson, LTC Beard, and a U.S. Army MP), OSCE, and UNHCR. The EU did not attend and had not provided a participant to any of the meetings thus far. The deputy administrator chaired the meeting since the regional administrator, Mr. Splite, was new and this was, in fact, his first meeting. There did not seem to be any specific agenda for the meeting. Instead, the meeting seemed to quickly center on a couple of concerns, the main one being related to the need for timely communication to the regional administrator of serious incidents in his area of responsibility.

The meeting opened with a long discussion about why it took 12 hours to inform the UNMIK regional administrator of a recent drive-by shooting that killed three and wounded two. The UNMIK administrator said he wanted Task Force Falcon to call them directly when an incident occurred. TFF suggested that this was an UNMIK police responsibility and noted also that there were no established procedures for doing this. In addition, there was no direct communications link between the MNB(E) TOC and the UNMIK control center in Gnjilane. UNMIK communications used the U.N. VSAT network and TFF was not a subscriber of this system nor was the U.S. military voice communications system connected to the U.N. system. Additionally, the local and regional telephone service was problematic and therefore could not be relied upon as a viable system to support emergency reporting between MNB(E) and UNMIK. If such a communications link was necessary for operational purposes, there was a possibility of using the KFOR voice network to call UNMIK in Gnjilane. There was an interface between the KFOR voice network and the U.N. VSAT voice network in Pristina that could be used for this purpose but it was a very limited operational capability. The MNB(E) TOC had access to KPN so there was a possibility for them to call UNMIK. It was noted by the UNMIK police representative that they had reported the incident under discussion to UNMIK headquarters in Pristina but had not called the Gnjilane control center. MNB(E) also noted that they reported the incident to KFOR

headquarters who reported it to UNMIK headquarters in Pristina. Apparently, UNMIK headquarters did not immediately contact the Gnjilane control center and since no one had directly contacted the regional control center this meant the regional administrator's bosses knew about the incident for some time before he did.

The UNMIK police representative stated that if the UNMIK regional administrator wanted the control center to be called, then they should be more specific about under what circumstances (murder, arson, etc.) and then appropriate procedures and communications capabilities could be set up to do so. It was noted that there were other possible means for MNB(E) and UNMIK police to communicate with the regional control center. The Task Force Falcon MPs and UNMIK police were now collocated at checkpoints and police stations. TFF MPs had access to UNMIK police radios so they could call each other for emergencies. This link could possibly be used as well to communicate with the UNMIK regional control center on critical incidents. The issue on the table was the proper procedure and means for alerting the UNMIK regional control center and who should be doing it, MNB(E) or UNMIK police.

A lengthy discussion followed on the confusion between facts and rumors surrounding incidents such as the shooting that had been discussed. There was a comment that delays in communication did not allow proper police work. Sometimes bodies were buried before an autopsy could be performed, so it was hard to build legal cases. The UNMIK police representative took exception to this statement by stating that they had professional police and did a proper job. It was noted once again that commercial communications in the region were poor and this added to the inability to inform. Finally, it was decided that the UNMIK regional administrator needed to think through his needs before any further action was taken on setting up a reporting structure.

The subject of the meeting shifted to the fact that war monuments would likely begin to be constructed throughout the region and some, in fact, had already been put up. The UNMIK policies on monuments, such as when and where they could be constructed, seemed a little fuzzy. Apparently there was a policy that stated that they needed to be kept a safe distance from the road. Many of those already constructed were, in fact, close to the road. In addition, UCK symbols were also being placed on the top of some of the monuments and this was in conflict with UNMIK policy on monuments.



Figure 1. Gnjilane Celebration Poster

In addition to monuments, there were celebrations being planned for the first anniversary as well. On Wednesday there was a local celebration of the liberation of Kosovo being planned for Gnjilane. When we arrived in Gnjilane, there were posters all over town depicting a young Bill Clinton with black hair, General Clark with three stars, and Ambassador Walker, the head of the Kosovo Verification Mission. A caption on the posters (Figure 1) stated that they had been invited along with other international dignitaries. The OSCE rep said he had been asked to speak but wasn't sure if he would, and wanted to know what KFOR and TFF were going to do. COL Anderson made it very clear that KFOR/TFF would not participate. They would only provide troops for security and protection.

There was a short discussion by the UNHCR rep and others about the U.N. desire to move IDPs and Croatian Serbs back into Strpce. There was an UNMIK initiative with OSCE assistance to move them, but not everyone agreed this was the right thing to do. Some believed that the Serbs in this area were being influenced from Belgrade.

The meeting adjourned and LTC Beard and I prepared to walk to Camp Montieth to have dinner before returning to Camp Bondsteel. As we left, we encountered a large crowd lining the main street of Gnjilane. Everyone was very well dressed. As we walked up the street, many shook hands with the soldiers, gave the V sign and said “thank you.” It turned out the celebration was for an old man who taught school in people’s homes during the Serbian reign and he had come back to set up an Albanian school. The town residents were out to honor his return.

Joint Security Commission Meeting

On one of my visits with Captain Barwikowski to the civil affairs office in Vitina, I attended one of the joint security commission meetings chaired by LTC Miles, U.S. Army. On the day I attended, the discussion addressed violence, protection for Serbs, refugees, and supplying food to the civilians.

The Vitina UNMIK administrator and the UNMIK Police Chief attended the meeting, along with OSCE, ICRC, ECMM, Albanian, and U.S. civil affairs representatives. Captain Barwikowski represented U.S. civil affairs. A Serbian representative was invited, but did not attend. It was not uncommon to have only one ethnic group attend such meetings. As a result, complaints and issues of an ethnic nature that were raised could not be immediately addressed because the other ethnic group was not present. Attempts were constantly made by KFOR to conduct joint meetings between neighboring Albanians and Serbs to work on issues face-to-face, but this was not easy to accomplish given the deep-rooted hatred each had for the other.

The UNMIK administrator was a few minutes late due to a protest in his office by some local Albanians who UNMIK hired to provide security for the building at night. With the recent increase in violence in Vitina, they wanted more money, radios to contact UNMIK police, and guns to protect themselves.

LTC Miles started the meeting with a discussion of various incidents over the past week and initiatives being pursued by KFOR. The other participants raised issues of interest that they thought KFOR might be able to help resolve or that would be of interest to KFOR. It was reported that a Serbian woman, whose husband had been shot and killed the week before by a neighbor, had returned to Serbia. UNMIK police had

arrested the neighbor so she fled fearing for her own safety. In response to a KFOR question on the location of Serbian families, one of the NGOs reported that there were three Serbian families living behind the bus station and five behind the hospital in Vitina. KFOR made the observation that Serbs were telling them where they would be working in the fields. There had been a number of recent driveby shootings, so they were seeking protection for the remaining few days that they would be working. The UNMIK Police Chief stated that he was increasing the presence of the Kosovo Police Service. There would be three shifts with more patrols in the evening. It was mentioned that there was a Serbian boycott in Gnjilane and they were not taking to internationals. A local Serb was reported to have gotten asbestos in his eyes and tried to get help at the Vitina hospital and Camp Montieth medical facility but could not, and had to go to a hospital in Serbia that had an eye clinic. It was noted that many of the NGOs were leaving the area since there was no further need for them. World Food had some seed left over and KFOR was going to store it for use during the next planting season. The meeting lasted roughly an hour.

Recruiting in Vitina

While on a visit with Captain Barwikowski and his Vitina civil affairs team, I had the opportunity to observe an UNMIK effort to recruit a Serb to work as a fireman on the all-Albanian Vitina fire department.

The Vitina UNMIK municipal representative, the UNMIK Fire Marshal, the Vitina Fire Chief, and U.S. civil affairs members met in a local school outside of Vitina to administer a test to Serbs wanting to try to qualify for the job of fireman at the Vitina fire department. As a side note, both Albanian and Serbian children used the school where the test was being held, one ethnic group in the morning and the other in the afternoon. The male Serbian candidates who passed the UNMIK administered written test would qualify to be given a physical before proceeding further with the selection process. UNMIK and the Vitina Fire Department were interested in males age 18 to 30. There were 14 men, mostly over 30, who showed up for the test. Three showed up in a Humvee escorted by MNB(E) soldiers.

When I arrived at the school with the civil affairs TST, we discovered UNMIK had not yet arrived. Since it was nearly 4 p.m., the scheduled

start time of the test, we decided to try to track down the UNMIK team. There was an OSCE registration center across the street from the school, and several UNMIK police cars and officers were sitting around outside the registration center talking. We asked one of the UNMIK policemen to call on his radio to see if he could track down the UNMIK person giving the test, but they were unsuccessful in their efforts to make contact. The Serbian candidates arrived by 4 p.m., but the UNMIK team did not arrive until 5 p.m.

Civil affairs SSGT Bowen, U.S. Army, had the lead to initiate the discussion through a translator with help from the UNMIK Fire Marshal and the Vitina Fire Chief. The whole effort appeared to be doomed for failure from the outset since UNMIK was only planning to hire one Serb to work at the all-Albanian Vitina Fire Department. The discussion in preparation for the test was held in one of the classrooms. The Serbian participants were very uneasy, and to some extent, hostile. The UNMIK team tried to reassure the Serbian men that they would be safe while working with the Albanians, but the Serbs were not convinced that this would be the case. The discussion got quite heated for a period of time. The Serbian men counteroffered to create a Serbian-manned fire department, but that was not part of the UNMIK plan to create a multiethnic fire department to work together for the betterment of Kosovo. UNMIK tried to convince the candidates that it was in their best interest to have a job and in Kosovo's best interest to work together to get the country back on its feet. The Vitina Fire Chief tried to reassure them, but nothing was working. The three Serbs who had been escorted by KFOR walked out early into the discussion and were followed later by several others. In spite of the valiant personal effort of SSGT Bowen, the UNMIK rep, the Fire Marshal, and the Vitina Fire Chief, the Serbs were not convinced that this would be a safe or a good employment opportunity. When the discussion was leading nowhere, the civil affairs team decided they had done the best they could under the circumstances and turned the rest of the discussion over to the UNMIK team. The UNMIK representative tried an alternative approach by suggesting there were other job opportunities, including paying them to play basketball. Basketball happened to be a national pastime and we saw hoops nailed to power poles and buildings everywhere. In the end, UNMIK failed in its effort to recruit any Serbian candidates.

Bilince and Lovce

I accompanied a PSYOP team to two Albanian villages (Bilince and Lovce) on the Serbian border. The Albanians contacted were afraid of renewed Serbian violence in their area. We met with several local leaders and were apprised of their concerns.

The PSYOP team met at 8:30 a.m. at the PSYOP SEAhut area for the morning operations briefing. Two team leaders, Staff Sergeants McCarthy and Langteau, U.S. Army, were leading the mission. We would be visiting two Albanian villages, Bilince and Lovce, which were located a few kilometers from the Serbian border. The mission was mainly to visit the towns to show an MNB(E) presence and to check on the local issues and concerns. There was also a growing concern that some troubles might occur after school let out for the summer and the team was asked to collect information that might indicate whether Serbs were planning to leave Kosovo during the summer months. The team was also reminded to advise Serbs that they could register at registration sites set up at the Serbian border.

Two Humvees were used for the mission. As we approached the exit from Camp Bondsteel, all weapons were locked and loaded and a radio check was made with the PSYOP CP as we left Camp Bondsteel and headed for Camp Montieth. We had to stop at the battalion TOC on Camp Montieth to let them know we would be in their area, the purpose of our visit, and to check the latest intelligence on activities in the area. Upon entering Camp Montieth, we had to stop and unload and clear all weapons before proceeding to the battalion TOC. Following the check-in with the battalion TOC, we left Camp Montieth for Bilince in two up-armor Humvees. Once again, before departing Camp Montieth, weapons were locked and loaded. Flack vests and Kevlar helmets were the uniform of the day.

It was a very hot day, but the Humvees were air-conditioned. Since it was very warm, an ice chest of cold water and drinks were essential for the trip. Our translator was a young Albanian man from Gnjilane who claimed he learned his English from watching American television and movies. He had a boom box hanging from the gun turret and for the duration of the trip, hard rock music blasted away—it reminded me of the movie “Good Morning Vietnam.” The Humvee had a GPS, 2 SINCGARS radios, an INMARSAT phone, and handheld Motorola

radios. Because of the mountainous terrain we were traveling through, SINCGARS communications to Camp Bondsteel were problematic. As an alternative means of maintaining contact, the PSYOP team monitored the battalion engineer and infantry radio nets.

MNB(E) had recently conducted a cordon and search of the town of Bilince, so the team was not quite sure what sort of reception they might receive. On the road to Bilince, the asphalt road had been mined at one time but the mines had been removed and the holes filled in, leaving the previous locations quite visible. We did a radio check before entering town and then dropped one team off at the beginning of the small village. The team I was with drove to the square in the center of town. There were no Serbs in this Albanian town as they all left after the war. As usual, the streets of the town were empty when we arrived. The kids were the first to show up (Figure 2); they seemed to come out of the woodwork. A couple of men eventually showed up and Sergeant Langteau and the translator started to talk with them. They sat down in the shade of a wall. The local men said water and electricity were fine. They emphasized that they hoped that KFOR would not leave since they felt safe now, but they would leave if KFOR did. They were afraid of the Serbs who had committed atrocities in their town. When the Serbs that had lived in the village left, the local Albanians burned their homes. One of the young girls standing around listening took me by the hand and walked me down the street. She pointed to a burned home and said, "Serb." When the men were asked about plans for the kids for the summer and returning refugees, they said the kids got out of school at the end of the month and would be staying in the area. As far as returning refugees were concerned, they said this was only natural.



Figure 2. PSYOP with Albanian Kids

The kids were real hams for picture taking. They would constantly pester us to take their picture. On earlier visits, the PSYOP soldiers took pictures of the kids and brought copies back and gave the pictures to them. Several of the kids were running around showing copies to us. Cows seemed to roam the town freely—a number of them walked through the square while we were talking. After the kids and several men arrived, an old man showed up and sat down to talk (Figure 3). He rolled his own cigarettes and was quite talkative. Later, the mayor of the town showed up as well. During the discussions, they said they had access to radio and television and had heard the KFOR radio shows. It was noted that they didn't get newspapers and would like to get more reading material. The PSYOP soldiers asked them if they had seen the KFOR *Dialogue* publication. They had not, so the soldiers said they would bring some newspaper and magazine handouts the next time they stopped by. At one point a young man came out of a house next to where we were sitting and offered us tea. We accepted and he brought it out to where we were sitting. It was hot and had a pretty good flavor. At the end of the discussion we all shook hands and left. Once back in the Humvees, we cleaned our hands with Dial antibacterial hand sanitizer. Without proper sanitary precautions, one could develop some strange rashes.



Figure 3. Old Man Talking to Translator

We tried to use SINGARS on our way to Lovce to contact the PSYOP CP at Camp Bondsteel but could not get through. Line of sight communications was pretty poor, especially in the valleys, villages, and towns. Lovce was a very small Albanian town. All of the villagers left the town during the war. We parked the Humvee at the top of the hill leading to the village and went into a small store and bought a Coke and some cookies. The countryside around the village was very beautiful, but as in other places, trash was dumped everywhere. Behind the Humvee was a mountain range and at the base was a known smuggling trail that could only be seen with binoculars. We ate lunch in the Humvee because if we ate outside the kids would have pestered us. As such, they still hung around the Humvees and looked in the windows at us eating.

An old man stopped by while we were eating and invited us to his home for tea. We accepted and, after our lunch of MREs, we walked down the hill to his home. When we arrived he shook our hands in the driveway and led us to the house. Since this was a Muslim home, we had to take our shoes off before entering. The scene was quite amusing—a half-dozen combat boots in a row outside the front door. I had to use the toilet and asked where it was. It was an outhouse on the edge of the patio near the front door to the house. As I walked into the outhouse, the smell was more than I could believe. The toilet

was simply a slit in the floor with two places to put your feet. The waste area was open on the backside and ran out into the area behind the outhouse that was next to the family garden. An interesting experience to say the least.

When we entered the house, one soldier stayed outside as our guard. The old man insisted that it was safe and wanted him to come in, but it was explained that he needed to be ready to go up the hill to the Humvee should we get a call. This seemed to be an acceptable explanation. The family gave the soldier on guard duty a cold drink, some walnuts, and tea. The front room had foam-covered seats on the floor that covered two sides of the room and this was where we sat. There was a bed in one corner of the room and this was where the old man sat. We took off our flack vests and helmets and placed them in the corner next to us, the soldiers kept their weapons next to them. A woman who was the mother of several of the children running around offered us a cold orange soda drink, obviously brought down from the store at the top of the hill just for this occasion. The children, being curious, came in and sat down next to the soldiers.

It was clear from the discussion with the locals that they had seen some terrible things. The mother still had reactions to gunfire and said the children had been traumatized. They were doing much better now that KFOR had arrived, and they were quite happy to see them. As the conversations with the old man went on, the kids got bored and left. The old man went into a long story about the VJ and Arkan's men. We were told by the Special Forces guys to be aware that over time stories take on a life of their own. The old man said that during the VJ/MUP reign of terror they went up into the mountains during the day and only stayed in the house at night. One day, he said, he stayed home and a VJ soldier saw him in his garden and pointed his rifle at him. He thought for sure he would be killed, but the soldier left him alone this time. Later, he said he ran into some VJ and then some of Arkan's men when he was trying to get to Gnjilane for medical treatment. When asked if there were UCK in his village, he said he told them yes, and that they were well armed. The soldiers then wanted names, but he said he did not know. They threatened to cut his throat if he did not tell. In order to get away, he said he would go back to town and get the names if they let him go. He said they let him go eventually.

More local men arrived, including the school principal, and joined the conversation that was being led by Sergeant McCarthy with the help of the translator. There seemed to be a pecking order. As various men arrived, they adjusted the seating arrangement. While the discussions were going on, one of the kids brought in a basket of walnuts. The mother came in somewhat embarrassed and said she was preparing them for us, but the little girl brought them in before she was finished. Several baskets were spread around for us to use, but there was only one nutcracker. The woman brought the tea to us in a small glass on small, individual silver trays. The kids brought in two big bowls of sugar. The first tea serving was already in the glass. There was one pot with strong tea and another pot with hot water for refills. The tea was pretty good. These were very poor people, but very gracious and hospitable.

At one point the town mayor showed up and became the focal point of the conversation that had been going on for well over an hour. He related an incident of a young child having his eye cut out and given to the father to eat as an example of the atrocities. Whole families were executed. The whole town left when the Serbs came in. The mayor said, "If this happened to your family, could you forgive?" One of the little girls in the room with us had lost her father during the fighting. The locals were afraid of the Serbs and what they might do if they returned. They liked KFOR and felt much safer now, but needed jobs, and asked for KFOR's help. They also mentioned that wild pigs (most likely were pigs that had belonged to Serbs that had once lived in the village) were eating their crops and wanted to know if it was okay to shoot them. They were told that as long as they were using weapons registered with UNMIK police, this should be okay. The local men were asked if they had seen any VJ/MUP activity recently and they said that they had seen soldiers in the woods. When asked if they were border guards—dressed in blue camouflage with baseball caps with a red rim—the PSYOP guys did not get a reaction. They told the men that these folks were not allowed in the area and that if they showed up, to report the sighting to KFOR. This was a small, isolated village, so they were very concerned about protection.

The young kids started running around and the father had to settle them down. When asked if they could ever live next to Serbs, the mayor said never, nor those who supported them. It was noted that maybe it was impossible to change the minds of the adults, but that the young children should be encouraged to look to a future of a multi-ethnic

society, for this was where the hope for Kosovo lies. The old man, along with the mayor and school principal, invited the KFOR soldiers back for further discussions. It was customary to shake hands when leaving the property, so we waited until we got outside. The trip back to Camp Bondsteel, except for the boom box music, was uneventful.

Clothing Distribution in Susice

I accompanied a PSYOP team to the Serbian village of Susice in the mountains near Strpce. The visit was to distribute clothing and toys to the locals. There was concern on the part of the locals that there were UCK in the mountains and this was a threat to their safety. Although attempts were made to keep the clothing distribution organized, it quickly got out of hand as the villagers tried to take as much as possible. Attempts to distribute candy and toys had similar results.

I met the PSYOP team at 8:30 a.m. at the PSYOP CP on Camp Bondsteel for the morning briefing before departure to the Serbian village of Susice to distribute clothes and toys that had been donated by organizations and people in the United States. Captain Davis, U.S. Army, led the team. A soldier from finance and combat camera went along as well. A Plugger GPS receiver was taken along because the town was located in the mountains above Strpce and the PSYOP team didn't want to make any mistakes since the maps of the area were not that good. The Humvees had SINCGARS radios, but these were essentially useless once leaving the Camp Bondsteel area. Motorola *SABER* and handheld radios for vehicle-to-vehicle and dismounted communications were taken along as well. The vehicles were loaded with 25 boxes that contained clothes, basic medical supplies, school supplies, candy, and toys. There were two boxes of MREs and water as well.

We stopped at the Polish Battalion (POLBAT) CP in Strpce and met with the commander. We told him our intentions and obtained a situation update for the area. He assigned a Polish platoon leader to escort us to Susice. It was interesting to note that the Serbian towns tended to be clean, whereas the Albanians tended to throw trash everywhere. The town of Susice was in a ski resort area in the middle of nowhere in the mountains. There was evidence of war damage along the road up to the village. The road was partially paved, narrow, and very steep at certain parts. It was a beautiful drive past fields of hay that were being harvested.

Upon our arrival in Susice, we were met by a number of the men from the town who began to tell the translator that they had seen UCK in uniform in the mountains shooting their weapons, and that they were afraid for their lives. As it turns out, Susice was the village where less than a week later, a shepherd disappeared and was subsequently found murdered about a kilometer from the village. The locals said no one shot at them directly, but they were still afraid to work in the fields and mountainside areas and wanted the Americans to send in some patrols. The men said that the U.S. had promised to come, but none had shown up. Captain Davis, through his translator, reminded them that this was an area patrolled by the Polish. In a discussion with the Polish platoon leader, he said that they patrolled the mountain area, but had not found anything. If UCK were really in the area, they probably would shoot a Serb, so one needed to take the accusations seriously.

The Serbian men were rather aggressive and less organized than normal. In order to do an orderly and fair distribution, the intent was to lay the clothes out in boxes and ask a member from each of the families to pick out some things they needed. This way, each family would get something. In principle this was a good idea, but it didn't work. When the first lady started to load up, the rest jumped in and control was quickly lost (Figure 4). People went a bit crazy and started digging into the boxes, taking everything they could get their hands on and arguing over who should get which items. It was a free-for-all. Some loaded up with so much that they were dropping things as they moved around. In the end, there were those who didn't get anything and disputes arose in the crowd. There were several arguments with a couple of ringleaders who seemed to cause most of the problems.



Figure 4. Clothing Distribution

For distributing the toys and candy, an attempt was made to try to get a little more organized and disciplined. The toys and candy were put on the roof of the Humvees and then the soldiers stood on the hood to try to organize the crowd. They tried to get them to line up, but this did not work. Next, they tried to get the kids up front and the adults in the back, but this did not work either. Finally, they just started to selectively hand out toys. Some adults were trying to position themselves so that they could get multiple toys. In the end, the situation became chaotic as well and once again there were those who did not get anything. There were even cases where adults were taking toys from little kids. Finally, the candy was passed out and again, the same situation happened.

The interpreter asked if the locals would like to hear a COMKFOR speech. They put a CD player on the hood of the Humvee and played the speech and some other stuff. The attention span of the locals was not long. It was noted without exception that information campaign products produced by the KFOR PSYOP support element in Pristina were dry and generated little to no interest among the local population. The general population wanted live radio shows with key figures involved in the peace process. Scripted products were an embarrassment to the soldier presenting them and an insult to the target audience. When the combat camera soldier started playing with some of the kids with a toy alligator, all started to watch and the CD player was put

away. There were some yo-yo demonstrations followed by show-and-tell picture taking. The combat camera soldier put on a Serb's hat and then the soldier put his vest on the Serb and took pictures. This went on for a while before it was decided it was time to leave. In the end, the visit was well received and distribution of clothes and toys were truly appreciated by most of the locals.

As we drove along the countryside to and from Strpce, we could see women and men harvesting the hay by hand. The hay was stacked on poles. There were carts drawn by horses and oxen in the fields and on the roads. There were tractors pulling carts. It was a contrast of both modern and somewhat primitive operations. There was also gravel mining out of the creek beds. The locals used makeshift sieves made out of wire mesh. We visited a beautiful church near Strpce that was being privately built by Dr. Aleksandrov using his own money, and we met the laborers building the church. They showed us around and explained what they were doing. On the way back, as we passed through a heavily mined area, we heard an explosion. It was not clear whether EOD was detonating or whether there was an animal that set it off. There were a lot of cows and sheep along the road. As we passed an area that had been flooded, there were several boys skinny-dipping in a mud hole. Kosovo was certainly a land of contrasts.

Abandoned Albanian Villages

While on mission with a PSYOP team, we visited the Albanian villages of Gornja Stubla, Vrnez, and Letnica. This was a destitute area, and some villages were essentially abandoned.

The Tactical PSYOP Team led by Staff Sergeant Trujillo, U.S. Army, stopped by Camp Montieth to check in with the 1-187 TOC and let them know we would be in their sector. As we drove out to the three Albanian towns, we drove through several Serbian towns. The kids and people were not very friendly in these towns. Albanians were much friendlier. The first town visited was Gornja Stubla, which was Albanian and quite a KFOR-friendly place. There were a number of kids walking around but they did not pester us. The PSYOP soldiers passed out some newsletters to the kids to take home to their parents. The TPT I was with went to the local school, which had been refurbished through the use of 80,000 DM provided by KFOR. The TPT team leader wanted to talk to the principal.

We gathered in the principal's office and the principal and several of the teachers came into the room as well. Everyone took off their vests and helmets and put their guns on the floor next to where they were sitting. The principal and his staff were smoking, so the translator and Sergeant Trujillo lit up a cigarette as well.

The purpose of the discussion was to collect information for a village assessment and to hand out newsletters and material on stray dogs. The TPT team leader asked a number of questions, such as where the nearest Serbian towns were located and how many Albanians lived in town. The principal said about 3,000 Albanians lived in town. When asked about their occupations, they said 90 percent were builders by trade, but there was no money to fund buildings. They said the money locals were spending came from family members living in Italy, Switzerland, and Germany. About 30 percent of the town had left to work in other countries, but would return soon. The school was for 5th grade and above and the kids were leaving for the day when we arrived. There were two other elementary schools for grades up to 4th.

Mother Theresa's picture hung on the wall of the principal's office, as well as an OXFAM calendar. The teachers said there were plenty of radio stations available and they heard KFOR programs. They also listened to VOA, RFE, BBC, and other stations. They said they needed a newspaper that gave them information on stations and broadcast schedules. They obviously listened to foreign broadcasts since they were disappointed that the UK lost a recent international football match. Newspapers seemed to be something they both needed and wanted. The locals said they heard about the KFOR *Dialogue* magazine and would like to get copies. The PSYOP team leader said they would bring some with them on their next visit.

The principal stated that in 1877 the first legal school was established, and the school we were visiting was the first Albanian school (founded in 1905) in Kosovo. The religion was mainly Catholic-Albanian. There was little crime in town, just some petty theft. Sometimes there would be people coming from other towns and stealing, but this was not considered a major problem. We were going to ask about clans, but our interpreter didn't understand what we meant. Sewage was still a problem and they needed about 7,500 DM to make some repairs. UNMIK said they would help with some funding. The residents were also concerned about cars speeding through town and wanted some speed bumps put

in. The speeders were usually Serbs who were drunk and trying to provoke a reaction. They did not feel safe without a KFOR presence. We ended the discussion and left some material to be handed out to the school kids.

The other TPT was out in the town walking around, meeting people, and going into the shops and talking to the owners and leaving material. We stopped by a shop and I bought everyone a drink. The shop had a variety of canned goods, sausages, pates, bread, and other staples. There were also hardware supplies such as nails, light bulbs, and even Turkish coffee pots. Although the inside of the shop was quite small it served as a local meeting place. There were several locals in the shop talking when we walked in. They were very friendly and we joked about speaking German, French, and Italian as well. In fact, about 120 local women and students had just returned from Italy. The locals were talking about folklore that said a treasure better than gold was in the local hills. The teachers at the school mentioned this too. It was never said what this really meant. The locals also claimed they found some interesting Serbian documents in the hills. We left the shop and headed towards the church in town where the other team had ended up. The team stopped and passed out some newsletters to some workers in the field. The owner of a shop invited us in for a free drink, but we told him we had to go and would return another day.

Next, we headed for the town of Vrnez. The turnoff was by the water bottling plant that the Marines had occupied when they were deployed in the Gnjilane Opstina. The road was pretty bad, very steep, and windy at times. We first came upon the town of Basici, which was uninhabited. We continued to drive towards Vrnez and saw abandoned homes along the way. Finally we came upon a man working in the field and stopped and talked to him but he did not give us much information. We continued up the hill until we came to the church in the center of Vrnez. Across the lane from the church there were two women who said this was a Croatian town. They said the people had left when the war started and had not returned. They had seen KFOR soldiers before, but we were the first to stop and talk. The Serbs occupied the town during the war, but there was no war damage. Most damage was from people stealing things after the village was abandoned. There were three or four families still in the town, but otherwise it was empty. We looked around at several buildings and it was clear from some that the people had left in a hurry. Clothes were still hanging on lines strung inside a house. Beds were

made and clothing was lying around. Utensils were still in some kitchens. Others had damage inside and there were animals living in the buildings. On the way out of town we even saw a cow come out the front door of one of the homes. Most homes had vandalism damage. A CARE vehicle passed us on our way out of the village.

Next we headed to the town of Letnica where we split into two teams and I went with one of the teams to the church of the Black Madonna and the other team started to walk around town. Several weeks earlier, I had been at the church with a civil affairs team and there had been a U.S. infantry platoon located there. In discussions with the locals we found out that they had left a couple of weeks ago, probably shortly after my visit. We went into the church, built in 1866, and asked whether the priest was there, but he was not. We talked to some ladies cleaning the church and then decided to take a walk around the area on the way back to the Humvees.

There were orchards in the area with pears, apples, and other fruit. We took the back way down to the square where our Humvee was parked and noticed the other team had been invited into a courtyard for a discussion with some local residents. A young girl went down to a shop on the square and brought back some soda for the group. We continued to walk and met four old men who had been consuming some of the local brew. One was the owner of a water mill we had seen at the base of the hill near the church and he offered to take us back to see it. Another man, who had obviously had plenty of the locally brewed brandy, insisted on shaking everyone's hand. We went to the mill and it was quite interesting. It was actually a functioning mill for grinding. The millstone came from Metrovica. We were given a demonstration of grinding corn. The mill was also hooked up to provide power as well. There were a lot of mill-related artifacts hanging around on the ceiling and walls. The owner said he also owned what used to be the Debrovnic hotel that was next to the mill. This was a rare opportunity to see a little of the local culture.

On the way back to Camp Bondsteel, we drove through some parts of the Vitina Serbian area that had received a lot of damage. We headed to Urosevac (Ferizaj) to drop off one of the translators at the bus station and then proceeded to the Greek compound to drop off some PSYOP material.

Demonstration in Zegra

I accompanied a combined PSYOP and combat camera team to Zegra to observe a manifestation for the 1-year anniversary of the UCK liberation of Kosovo. The event included a 5K run, soccer match, handball match, march by ex-UCK fighters, folk dancing, and speeches. There were some concerns that the demonstration could get out of hand if alcohol abuse became a problem, and PSYOP was there to help with crowd control. Luckily, there were no problems and the event was quite peaceful.

The combined PSYOP and combat camera team with an Albanian interpreter left Camp Bondsteel around 10:45 a.m. on a Sunday for Camp Montieth. Staff Sergeant McCarthy led the team. Since the manifestation was scheduled for the afternoon, it was decided we should have lunch at Camp Montieth and then get an intelligence update from the TOC before heading to Zegra. The mission was to provide loudspeaker operations to support crowd control and to photograph suspects of interest, such as ex-UCK members and other leaders that may attend the event.

Zegra was an Albanian town that had sustained heavy damage during the war. When we passed through town it was obvious it had come under heavy shelling during the war and parts of the town were leveled. The Serbs apparently lobbed shells over the mountains surrounding the town.

There was concern that drinking might lead to demonstrations, so the military was prepared, including non-lethal weapons for riot control. The military had gas masks—I did not have one. We parked our Humvees in the U.S. military ABU base camp on the outskirts of town. The Humvees were parked in the military compound since during earlier experiences with demonstrations, the military found themselves in situations where they could not drive out of the demonstration area because demonstrators blocked the roads. The plan was to walk to a school in the center of town where the PSYOP team would set up its operation. If we ran into problems, we would high tail it back to the ABU base for safety.

Zegra was in the Gnjilane Opstina. Since there were Serbian towns nearby, tactical control points (TCP) were set up at key access roads

and intersections to control the flow of traffic into and around the area. Typically, during such events, the Albanians got drunk and drove around wildly with the Albanian flag on a pole hanging out the car window. They would drive at high speeds through the Serbian neighborhoods trying to provoke an incident or sometimes executing a driveby shooting. The military was also concerned that the UCK would march with uniforms and patches, which they were not supposed to do, and this would start some celebrative actions or demonstrations if the military stopped the parade.

The walk from the ABU base, which was some 2 miles away to the center of town, was not tough for me, but for the PSYOP and combat camera soldiers it was more of a challenge. The TPT soldiers had to carry the loudspeaker system, INMARSAT phone, and other equipment. The combat camera team had two video cameras, digital still cameras, and other equipment. The job of the combat camera team was to film the event and suspicious individuals. It turns out that not only was combat camera filming the event, but many of the other soldiers were filming as well. Nearly every soldier on the ground had his own camera with him and everyone was taking pictures of the event.

The schoolhouse was three stories and we used the upper floor to set up the operation. The classrooms were pretty sparse with only a few desks. The floor in the classroom was wooden and had large cracks filled with trash. Some of the windows were broken as well. PSYOP set up shop and combat camera started filming out of the windows. The PSYOP team set up their speaker system and the INMARSAT phone in case they needed to use it. Sergeant McCarthy (Figure 5) made several calls to the PSYOP CP to report the status of the operation.



Figure 5. PSYOP Soldier on INMARSAT Phone

The 5K run was just coming to an end when we set up our operation in the school. The finish line was a small rope stretched across the road with a soda can tied to it in the middle. The runners did not wear sneakers or running shorts. Instead they were dressed in their street clothes. A lone runner appeared and crossed the finish line followed by several others. The crowd was small but began to grow as time passed. A few vendors set up stands to sell ice cream and drinks. The soccer match was played on an asphalt surface. Goals were placed at either end of the play area that was bordered on two sides by destroyed buildings. Kids sat on what was left of the roofs of the buildings to watch the match.

We decided to go down and walk around the area during the soccer match. There were a lot of young kids who came around asking our names, how old we were, or asking us to give them something. The soccer match ended without a problem and then there was a handball game. After the handball game, they played music and had some folk

dancing in anticipation of the ex-UCK marching into the area for the speeches and remainder of the program.

After quite some time we could see the line of ex-UCK soldiers in various camouflaged outfits marching up the road in the distance. The military strategically positioned the Humvees along the road and in an intersection in front of the school so that the marchers would be forced to march in a particular area. The combat camera team set up their operations on both sides of the road so they could film the UCK marchers as they passed. As the marchers got close to the ceremony area, the UCK marching song was cranked up on the public address system and the crowd began to clap, cheer, and sing to the marching song. The marchers did not have UCK patches on their uniforms nor did they mind having their photograph taken—normally they would have avoided having their pictures taken. The ex-UCK marchers lined up in the area where they had been playing soccer and the Kosovo and U.S. national anthems were played. Following this there were speeches, poetry readings by children, awards and certificates were handed out, and even Captain Bell, the ABU base commander, was invited up to receive a certificate. Speeches were intermixed with singers and dancers who started to perform just as we were getting ready to leave. Everyone seemed to behave quite well without any incidents.

Kamenica

On a visit with the Kamenica civil affairs team, I had the opportunity to observe a multi-ethnic open-air market in operation and participate in civil affairs team activities in a Serbian enclave including a meeting with Serbian religious leaders.

Kamenica was one of the few markets where Romas, Serbs, and Albanians could congregate together without any problems. We had a meeting scheduled with the local Serbian church board, but before meeting we walked around the Serbian enclave and then to the market area. In the Serbian area, there was a female doctor who ran a medical clinic for treating Serbs. She was part of the NGO “Pharmacies Sans Frontiers.” In order to treat Serbs living in remote areas, KFOR frequently provided her with an escort service to remote Serbian villages. We passed a Serbian school that was being held in a storefront. Like the Albanians under Serbian rule, the Serbs under Albanian rule

now used private facilities to teach their children—it was too dangerous to go to some schools in Albanian areas. The street that provided access to the Serbian enclave was blocked with old pieces of car parts and rocks in order to block access to young Albanians who frequently would drive their cars through the streets at high speeds. Major Ricci, U.S. Army and the civil affairs team leader, was well liked. As we walked around town, people stopped him, talked to him, and invited him for tea and lunch.

The market area consisted of three sections: Roma, Serbian, and Albanian. The Roma section was the smallest with just a couple of vendors and the Albanian section was the largest and provided items such as food, clothing, toys, cigarettes, and hand tools. The meetings with the church leaders were held frequently. The purpose was to keep a dialogue going with the religious leadership by telling them things KFOR was doing for the community and asking them about issues that civil affairs might help them resolve. There was also a lot of disinformation and misperception of events. One of the values of the meetings was providing clarification of incidents, such as some recent Serbian shootings and arson at private residences. The church elders asked civil affairs to help stop the dumping of garbage in the streams as it was making the children sick. With the upcoming first anniversary of the liberation of Kosovo from Serbian rule, the Serbian community was concerned about security during Albanian-led celebrations and asked for additional KFOR security during this period. Major Ricci agreed to look into trying to help where he could. Kamenica was in the Russian sector of Multinational Brigade East and did not have a civil affairs unit, so a U.S. civil affairs team supported this requirement and set up an information center in the UNMIK municipal building. There were no Russian translators to directly support the civil affairs team, but there were Russian speaking U.S. soldiers supporting the SOF liaison teams and the U.S. intelligence support operation at the Russian base in Kamenica.

CHAPTER XXVII

A Continuous Learning Process

Larry Wentz

Lessons-Learned Activities

Numerous national, international, and NATO initiatives attempted to collect experiences and derive lessons from Operation Joint Guardian, but like past efforts, these initiatives were not coordinated and there was no one responsible for pulling together the civil-military story. There was no common process or set of goals driving the collection and analysis of military experiences. These initiatives varied in breadth and depth, as well as in feedback and the dissemination of findings. Open sharing of findings among the various participating organizations was limited at best and active sharing of military findings among civil and military organizations was essentially nonexistent. In particular, the official military reports tended to be classified, restricted access, or placed on classified Web sites with controlled access.

There was some limited open source publication of experiences and lessons. These reports ranged from official to unofficial and national to international documentation of personal and unit experiences from Kosovo. For example, the NATO *Review* and NATO's *Nations* publications presented summaries of successes and challenges in articles written by senior NATO and national military and civilian officials. Web sites for the UN, UNMIK, NATO, SHAPE, KFOR, UK MOD, U.S. DoD, and Task Force Falcon published some experiences, but open access to some these sites (the U.S. military ones in particular) became more restricted over time. There were special reports by international organizations such as the UNHCR, OSCE, and EU, and other humanitarian assistance organizations and multinational organizations, such as the International Crisis Group and International Management Group. The reports of these organizations were posted on their Web sites and contained some specific issues and

recommendations. Individual and unit experiences were also documented and published in professional journals, conference proceedings, and government publications, such as the U.S. Joint Center for Lessons Learned (JCLL) bulletin produced by the Joint Warfighting Center (JWFC) at Joint Forces Command, and the Center for Army Lessons Learned (CALL) newsletter and Web site.

Within the international military community, there was no leadership for compiling combined multinational military lessons learned. Unlike Bosnia, there was no in-country NATO Joint Analysis Team collecting Kosovo lessons. There were separate ARRC, KFOR, SHAPE, and national lessons-learned activities. Within the U.S. military elements, there were several uncoordinated activities. The commands, services, agencies, and intelligence organizations conducted separate lessons-learned activities and contributed joint lessons to the Joint Universal Lessons Learned System (JULLS) for broader circulation and resolution actions. This was a bottom-up approach and heavily dependent upon decisions at the lowest levels to determine what constituted a joint lesson. U.S. EUCOM facilitated the collection of joint service and agency theater-level lessons. The USAREUR Lessons Learned Team under the Operations, Plans, and Training Analysis Branch (OPTAB) collected the Army experiences and lessons for the U.S. Army in Europe participation in Kosovo. Neither USAREUR nor CALL provided an in-country team to collect experiences and lessons from Kosovo and Task Force Falcon. CALL published some unofficial individual and unit experiences in their newsletters and on their Web site. The JWFC JCLL, whose mission is to share lessons with the joint community, solicited and published individual and unit lessons-learned articles in their publication, the JCLL bulletin.

The U.N. Department of Peacekeeping Operations' Lessons Learned Unit conducts lessons-learned studies, but in 2000 none had been conducted yet since it was only the first year of what was anticipated to be a multiple year operation. The U.N. normally performs a mid-mission and end-of-mission assessment for all of its operations. Visits are made to mission areas, interviews are conducted with key personnel, open source material is reviewed, end of tour reports are collected and assessed, and seminars are conducted to capture and document lessons learned for a particular operation. This documentation and assessment approach may benefit future operations, however, it provides no living feedback during the course of an ongoing operation. There is hope

that live lesson learning may be introduced some day. In the U.N. *Brahimi Report* of the Panel on United Nations Peace Operations, dated August 21, 2000, it states that lessons learned should be thought of as information management that contributes daily to improving operations, and post-action reports should be only one part of the learning process.

Many ongoing lessons-learned efforts focused on either the civil or the military aspects with little emphasis on an integrated view of the military, political, humanitarian assistance, and civil reconstruction aspects. No single organization in the international civil-military community had the responsibility for coordinating the various efforts and pulling together a coherent big picture. The U.N. comes closest to fulfilling this role, but as noted earlier, their lessons-learned reports generally do not come out until after the mission has been completed. There was also no organization responsible for the dissemination of information to those who participated or were about to participate. Furthermore, the military lessons-learned reporting was incomplete, largely due to a reluctance to report failures. The success-oriented military incentive system did not positively reward the reporting of mission failure-related issues. These mission details were rarely forwarded for review and those that did get forwarded were usually edited until they no longer addressed the failure issue. There was also military pressure for lessons reflecting operational vulnerabilities to be either classified or never released. Unfortunately, this introduced the possibility of limiting feedback to those who needed the information to prevent future failures.

The process for collecting experiences and lessons ranged from highly structured real-time feedback to simple documentation and archiving. There were approaches, such as the process used by the ARRC, which focused on real-time learning. In this reporting process, failure-oriented issues that needed corrections were quickly assessed. Courses of action were then developed and implemented to ensure that they resulted in a lesson learned. The ARRC was proactive and established a lessons-learned branch as part of its deployed headquarters' staff. Its mission was to collect, analyze, validate, and implement lessons learned in order to improve the ARRC headquarter's ability to plan and conduct operations. The process was aimed at providing real-time feedback and follow-on action to ensure continuous learning, correction of mistakes, and recognition of success where appropriate. This process was, however, the exception and not the

rule—other lessons-learned activities were more reactive and reluctant to report on themselves by openly sharing failures. Most organization-sponsored lessons-learned activities were aimed at documenting their experiences and lessons at the end of each unit's rotation, and then assessing and integrating the findings over time. After extensive multilevel command reviews, they published the sanitized findings and then took remedial action. These processes lacked the honesty, timeliness, and dissemination necessary to ensure continuous learning and improvements. As a result, new units arriving in theater experienced many of the same problems as those that preceded them.

SHAPE established a Joint Analysis Team to collect and publish KFOR lessons learned. However, unlike the IFOR/SFOR JAT, there was no proactive in-country team of observers specifically tasked to collect insights for KFOR lessons. Inputs were generally received from the field and then analyzed and integrated into an overall KFOR lessons-learned package at SHAPE. U.S. EUCOM was the theater focal point for assembling the U.S. joint lessons learned inputs for JULLS, and this was done through coordination meetings with the service and agency representatives and the collection of inputs from the field. Kosovo lessons were published on the EUCOM classified Web site as well and could be viewed by those who had U.S. SIPRNET access.

At the Task Force Falcon level, the G3 Plans shop was responsible for pulling together the TFF After Action Review (AAR) for the 1st Infantry Division (1 ID) participation. There was no lessons-learned shop that collected and analyzed experiences and lessons over the duration of each 6-month tour rotation. The purpose of the AAR was to capture the lessons learned and general issues associated, for example, the TFF 1B operations. The 1B AAR that was being assembled when I arrived in Kosovo was an input to a larger structure that was aimed at capturing the key challenges faced by 1st ID participation in the first year of the Kosovo operation. The intent was to publish a unit history that provided an overall background, sequence of events, and summary of Army support to KFOR and MNB(E) activities and lessons. Additionally, the USAREUR OPTAB Lessons Learned Team collected the AARs that were produced by each unit and was tasked to put together a USAREUR lessons-learned story for the broader Army participation in the Kosovo operation.

In order to put the TFF 1B AAR together, they established a framework to capture strategic, operational, and tactical lessons for the patterns of operation that included building the team, training the team, deploying, employment, sustaining, redeploying and TOA, and reintegration. Major emphasis was placed on the employment portion of the AAR and the key operational components of maneuver, intelligence, engineer, fire support, air defense, signal, aviation-A2/C2, MP, information operations, CMO, signal, and command and control were the focus of documenting experiences and lessons learned. AARs from major events such as the Metrovica operation, the Sevice riot, and the Gornje Kusce cordon and search were included as well. A tight schedule was established and carefully managed in order to complete the AAR by June 19, 2000, the day before the transfer of authority to the 1st Armor Division.

The AAR process started with all units and staff assigned to TFF providing initial inputs to TFF G3 Plans by May 10, 2000. Additional inputs were submitted throughout the next several weeks of the AAR process. My arrival in Kosovo at the end of May coincided with the preparation of the first draft of the 1 B AAR. In support of the continuing AAR processes, I conducted interviews with each of the major command elements, visited facilities, and participated in selected operations as a means to help draw out additional insights and lessons to be used by the 1B AAR team. Two roundtable meetings were conducted as well. One was with the primary staff and the other was with the TFF commander and his staff, including the multinational commanders assigned to TFF. The inputs received by the G3 Plans AAR team varied in detail and format. The final draft of the 1B AAR was completed by June 19 and taken back to 1st ID headquarters for incorporation into its KFOR unit history and publication. As noted earlier, the 1B AAR was also made available to the USAREUR team, which was compiling a broader picture of Army experiences and lessons in support of the Kosovo operation.

A number of articles on experiences and lessons emerged since the beginning of Operation Joint Guardian. There have been high-level status reports and reflections of 1-year achievements and challenges published by senior leaders such as the NATO Secretary General Lord Robertson and others. Examples of KFOR and U.N. publications include:

- *Kosovo: One Year On*, by the NATO Secretary General Lord Robertson (www.nato.int/kosovo/repo2000/better.htm);
- *Reflections on KFOR's Contributions* by COMKFOR General Klaus Reinhardt (Summer-Autumn 2000 issue of the NATO Review);
- *Report to the Security Council on UNMIK*, by U.N. Secretary General Kofi Annan (www.un.org/Depts/dhl/da/kosovo/kosovo3a.htm); and
- *UNMIK Status Report*, by the Senior Representative of the Secretary General Dr. Bernard Kouchner (www.un.org/peace/kosovo/pages/kosovo1.htm).

Other publications from the U.S. military and various international organizations include:

- International Crisis Group (ICG), *Kosovo Report Card*—success and failures of NATO and U.N. efforts and organizations, 8/00;
- International Management Group (IMG), *Kosovo Telecommunications Damage Assessment*—cost estimates to repair and modernize the country's communications—www.img.ba/kosovo/main/telecom/index.html, 10/99, 3/00, 5/00, 6/00;
- Humanitarian Community Information Center (HCIC), Humanitarian issues, municipal profiles, and civil reconstruction—www.reliefweb.int/hcic/;
- *ARMY*, the magazine of the Association of the U.S. Army, Experiences and lessons of the 82nd airborne, 505th parachute, and 1st ID (mechanized), 9/99;
- *Marine Corps Gazette*, Experiences and lessons of the 26th MEU, 11/99;
- Engineer Professional Bulletin, *The Engineer Regiment in Kosovo*, 4/00; and
- Military Police, *Military Police Functions in Kosovo*, 5/00.

The need to capture experiences and lessons learned is certainly widely accepted, but collaboration, coordination, and open sharing continue to be problematic and challenging for the civil-military community. The prospect of one organization taking on the role of facilitating collaboration, coordination, and sharing to create a coherent big picture for peace support operations is unlikely at this time. Improving the sharing of experiences and lessons is certainly more likely. The information networks today, such as the Internet, have demonstrated their utility as the means to communicate among those willing to share. The efforts of the HCIC to promote more open information sharing and use of its Web site to do this is an excellent example of what can be done today. In the end, coordination and open sharing will be a result of the political will of the nations and organizations involved. If nations and organizations want to share, then they will make it happen. The challenge for the civil-military community is to promote more open sharing by doing it during real operations, but this will not be achieved until someone attempts to organize and lead such an effort.

The civil-military lessons-learned system is dysfunctional and urgently needs improved. Both the civil and military processes need to reward the reporting of failures as well as successes and they need to be a real-time learning process with immediate feedback, and not simply a historical archiving process to fill bookshelves or classified databases and libraries.

The approach used by the ARRC to capture real-time experiences and turn them into lessons learned could serve as a model for other militaries and civil organizations for future peace support operations. Openly presenting current experiences and lessons on Web sites is also an approach to consider for improved sharing and to facilitate continuous learning.

Some Concluding Observations

HOOAH (pronounced Who-A) to the men and women of the U.S. military, to the civilian and contractor force, and to the allied partners that made the military mission in Task Force Falcon a success. Agility and accommodation continue to be keys to success, as well as some plain old good luck. In the final analysis, however, it was the professionalism, dedication, ingenuity, and personal sacrifices of the

men and women who were there (and those who supported them) that made it happen.

As noted at the outset of this chapter, the observations presented herein are not meant as a criticism, but simply intended to reflect the reality of the situation and attempt to help provide the reader with a better understanding and appreciation of the daily environment of a peace support operation. A lot has been and continues to be learned from Operation Joint Guardian. Some of the experiences will shape the nature of future military support to peace support operations and others will be revisited in future operations. The Center for Army Lessons Learned says, “a lesson is learned when behavior changes.” The Kosovo observations presented herein contain both lessons learned and lessons yet to be learned.

There is no priority of importance implied by the sequence in which the following observations are presented, but the most important lesson that appeared in every AAR reviewed was “Kosovo is not Bosnia.” Some realities of peace operations:

Operations Planning and Preparations

- Ill-defined and fuzzy political end states will be a given.
- A political-military strategic plan for the operation will be lacking.
- Multinational military planning will be fragmented with little collaboration and cooperation with non-military actors and between national military elements.
- In spite of good soldier training, there will be a need for additional training to prepare units for peace operations, including training once in country. Training will be needed to develop skills in policing, conducting town meetings, negotiating and resolving conflict, crowd control and use of non-lethal weapons, and urban combat techniques.

Multinational Operations and Relations

- Competing international and national political agendas will be the norm.
- Multinational command arrangements will be politically driven and complex.
- Parallel national chains of command will exist and need to be accommodated.
- Politically driven force caps, not troops-to-task analysis, will drive force composition planning and implementation.
- It will be necessary to manage the expectations of all participants—political, civil, military, and the public in general.
- In multinational operations, the best semblance of unity that can be achieved will be unity of effort.
- Stovepiped NATO and national C4ISR systems will continue to be deployed to support contingency operations, creating interoperability and security disconnects.
- The potential adversaries of NATO (and the U.S. in particular) will not overlook the weaknesses exposed in the NATO-led multinational operation.
- Coalition military doctrine, intelligence, and decisionmaking processes, and the performance of the C4ISR systems supporting the operation, have yet to be truly tested under live hostile fire. Doctrine and tactics based upon an assumed freedom to communicate and ability to achieve information dominance may not be sufficient in the future.
- Active counter measures against dependence on information may be needed in future operations, including peace operations. Virus attacks experienced by NATO and national military networks clearly demonstrated the vulnerabilities of these information networks and need to proactively protect against such intrusions. Intentional attacks against NATO information and information systems were experienced in both the air war over Serbia and the Kosovo operation.

Civil-Military Operations and Relations

- The key to military exit strategy will be the success of the international presence in civil reconstruction efforts.
- Civil organization (e.g., U.N.) activities in country will slow the military and need to be accommodated. The success of these organizations is key to military exit strategy.
- Non-governmental organizations will be in country before the military arrive, will continue to be there while the military is present, and will remain when the military leave. It will therefore be necessary to deal with these organizations as meaningful participants in the operation and leverage their strengths.
- Civil and military actors do not yet adequately understand one another's motivations or modes of operation. This lack of understanding and cooperation will be confusing, wasteful, and potentially dangerous, especially if these differences are ignored during the planning stages of military deployments.
- The Balkanized approach to civil-military operations reflects the lack of overall unity of effort for NATO forces. KFOR headquarters was a coordinating (rather than a command and control) headquarters. The MNBs were relatively independent and thus had approaches to CMO that were more indicative of national political priorities and military operating styles. The CMO activities were hampered by the absence of an overarching campaign plan and means for measuring the status and effectiveness of the CIMIC lines of operation at the municipal and maneuver unit level.
- The military can mobilize personnel and resources like no other institution. It can carry those resources great distances. The humanitarian assistance world is very different. It is primarily built on donations and well-intentioned individuals who are willing to place themselves at risk for little compensation. The military must be prepared to work with and assist organizations which are not well supplied, prepared, or equipped.
- The military must accept that there will be a fundamental difference between its training and attitudes and those of the

international organizations and non-governmental organizations engaged in relief and rehabilitation. The humanitarian community will focus its planning energies on the victims of tyranny, cruelty, and disorder. These civilian organizations will be committed to assisting all non-belligerents in need, without regard to ethnic group or political faction.

Military Flexibility

- Force protection, while not a mission itself, will be a high priority consuming manpower, resources, and time.
- One-size-fits-all models do not apply to peace support operations. No two operations will be the same.
- National military rotation policies generate continuous turnover of commanders and staff and this will create turbulence and pose leadership and continuity challenges.
- Trust and confidence will be essential elements of building new teams and integrating teams into ongoing operations. Trust must be earned, so it will be essential to start to build the team before deployment, including formal training as well as informal opportunities for the leaders and staff to socialize and to build confidence as a team.
- It will be feasible to use commercial communications and information systems, products, and services to satisfy military command and control needs. Such use is on the rise and is cost-effective, but there will be security risks that need to be addressed when using these products and services without appropriate security protection.
- The Presidential Selective Reserve Call-up system was created to respond to Cold War needs and may therefore be inappropriate for the continuing demands of peace operations that include units such as civil affairs, MPs, PSYOPS, and combat engineers.
- Civil affairs, PSYOP, combat camera, and information operations will be force multipliers in peace support operations.

- Peace operations require soldiers to confront dangerous and lethal environments as well as to maintain safe and secure environments. This requires mental and organizational flexibility that encompasses high-intensity training as well as the softer skills of humanitarian assistance, checkpoints, presence patrols, negotiations, and critical cultural understandings.
- Battle rhythm can be brutal, and so staff burn out can be a serious concern requiring continuous efforts to encourage staff to get adequate sleep and take time off to relax.
- It will be necessary to more effectively exploit information technology at the tactical level.
- Complacency must be avoided even as a return to normalcy occurs.
- Although soldiers faced threats of violence every day, the potential adversaries were largely compliant with the Military Technical Agreement and took few actions to interfere directly with KFOR activities. It was a policing and civil reconstruction effort. Many viewed the operation as a success because there were no major military casualties. This mindset is dangerous because it sets a precedent for expectations that peacekeeping missions are routine and will not involve failures or casualties. Political leaders, next generation commanders, and the general population may not be mentally prepared for the sort of reverses that can easily befall those involved in more hostile military operations.

Military Intelligence

- Military knowledge and understanding of the roots of conflict, religion, culture, traditions, economics, and politics of the region will be lacking.
- Intelligence needs to be able to conduct and collect traditional hard-targeting analysis supporting military courses of action to maintain a safe and secure environment and suppress terrorist activities. At the same time it also must be able to conduct soft analysis of political organization intents, economic needs, civil

unrest, disturbance intents, vigilante and rogue warrior capabilities and intents, refugee movements, international organization and NGO activities, civil infrastructure, and criminal activities.

- Traditionally, military intelligence is collected to provide information about an operation that the military has already decided to undertake, but for peace operations, intelligence and information will be collected in order to determine future military action.
- Establishment of effective communications capabilities and media policy will be important to the overall success of operations. The military public information team needs to be deployed early, in sufficient numbers, and with communications and information capabilities comparable to those used by the press.
- Military-media relationships need to be established and nurtured as early as possible. The press must be educated as much as possible on the policies, people, and equipment that comprise military operations.
- Interpreters (translators) are cultural liaison agents. Their allegiance will not necessarily be with the military organization supported. Additionally, many times translators interpret and add their own connotations, and this needs to be carefully managed.
- Information operations require an overarching strategic plan containing clear and measurable objectives and the commander's personal involvement and leadership.
- Current information and intelligence systems processes are inadequate to meet the needs of multinational, multi-agency, and civil-military operations. Complex humanitarian emergencies require a capacity to share information, promote cooperation, and, where appropriate, coordinate action among all relevant actors. Information sharing among the civil-military actors continues to be problematic.
- Continuity of situational awareness will be critical.

CHAPTER XXVIII

Section 5 References

- ARMY Magazine*, September 1999. "Kosovo: A Special Report." Association of the Army Press Arlington, VA.
- ACE Rapid Reaction Corps, 1999. *Lessons Learned Report (Draft)*. ARRC Headquarters Monchengladbach, Germany.
- Clark, Howard, 2000. *Civil Resistance in Kosovo*. Pluto Press, Sterling, VA.
- Clark, Wesley, 2001. *Waging Modern War*; Public Affairs, a member of the Perseus Books Group, New York.
- Daalder, Ivo and O'Hanlon, Michael, 2000. *Winning Ugly: NATO's War to Save Kosovo*. The Brookings Institute, Washington DC.
- Emerald Express 99-2, 1999. *Conference Report on 26th MEU and PHIBRON 2 Participation in the Albanian Humanitarian Assistance, Kosovo Peacekeeping, and Turkey Disaster Relief Operation*. Marine Corps Research Center, Quantico, VA.
- EUCOM J6 Report, 2000. *A United States European Command J6 Perspective of the Kosovo Crisis*. USEUCOM Headquarters Patch Barracks Vaihingen, Germany.
- Hammond, Philip and Herman, Edward, 2000. *Degraded Capability: The Media and the Kosovo Crisis*. Pluto Press, Sterling, VA.
- Hesser, Fran, 2000. *Kosovo Prospectives for Peace Journal*. Web site: www.cnn.com
- Independent International Commission on Kosovo, 2000. *The Kosovo Report*. Oxford University Press Inc., New York.
- Janes Defense Weekly*, 22 March 2000.

- Laurenti, Jeffrey, 2001. *The Preparedness Gap: Making Peace Operations Work in the 21st Century*. UNA-USA Policy Report, New York.
- Marine Corps Gazette*, November 1999. "The Kosovo Commitment."
- McClure, Robert, 2000. *The Engineer Regiment in Kosovo*. Engineer Professional Bulletin, April 2000.
- Moskos, Charles, 2000. *The Media and the Military in Peace and Humanitarian Operations*. Robert R. McCormick Tribune Foundation, Chicago, IL.
- NATO NATIONS, January 2000. *K/SFORce for Peace*. Monch Publishing Group Bonn, Germany.
- NATO Review, Summer 1999, Autumn 1999, Summer-Autumn 2000. *Articles on Kosovo operation*. NATO Office of Press and Information Brussels, Belgium.
- Peace Pledge Institute, 2000. *Kosovo Conflict Background*. Web site: www.ppu.org.uk
- Schnabel, Albrecht and Thakur, Ramesh, 2000, *Kosovo and the Challenge of Humanitarian Intervention*. United Nations University Press.
- Swengros, Richard, 2000. "Military Police Functions on Kosovo." *Military Police Magazine*, May 2000.
- Task Force 1-63 Armor, 2000. *After Action Review for KFOR IB*. Camp Montieth Kosovo.
- Task Force Falcon, 2000. *1st ID After Action Review (Draft)*. Camp Bondsteel Kosovo.
- USAFE Report, 2000. *Air War Over Serbia*. USAFE Studies and Analysis Directorate Warrior Preparation Center Einsiedlerhof, Germany.
- USAFE/SC Report, 1999. *USAFE Communications Supporting Operation Allied Force and Joint Task Force Shinning Hope*. Headquarters USAFE Ramstein AFB, Germany.

- Wentz, L. K., 1998. *Lessons from Bosnia: The IFOR Experience*. Washington DC: CCRP/NDU Press.
- Wentz, L. K., 1999. *Lessons from Kosovo Phase I Report*. Washington DC: ASD(C3I)/CCRP.
- Wentz, L. K., 2000. *Notes from Kosovo Visit May-June-July 2000*. Camp Bondsteel Kosovo: Task Force Falcon.
- Woodcock, Alexander and Davis, Dave, 2000. *The Cornwallis Group V: Analysis for Crisis Response and Societal Reconstruction*. The Canadian Peacekeeping Press, Lester B. Pearson Canadian International Peacekeeping Training Center, Clementsport, Nova Scotia.

Internet Web Sites

- BBC News (Kosovo: One Year On): <http://news.bbc.co.uk>
- NATO Official Homepage: <http://www.nato.int/>
- SHAPE Headquarters: <http://www.shape.nato.int/>
- Allied Forces South: <http://www.afsouth.nato.int/>
- KFOR Online Homepage: <http://kforonline.com>
- NATO & Kosovo: Index Page [access to Operation Allied Force Operational updates, morning briefings and press briefings]: <http://www.nato.int/Kosovo/all-frce.htm>
- NATO & Kosovo: Operation Joint Guard [KFOR Press statements and news conferences]: <http://www.nato.int/kosovo/jnt-grdn.htm>
- NATO Basic Fact Sheet [NATO's Role in Relation to the Conflict in Kosovo]: <http://www.nato.int/docu/facts/2000/kosovo.htm>
- NATO Kosovo Strike Assessment: <http://www.nato.int/kosovo/press/p990916a.htm>
- Task Force Falcon Online Homepage: <http://www.tffalcon.hqusareur.army.mil/home.htm>

U.S. European Command: <http://www.eucom.mil/>

U.S. Defence Department [Lessons Learned] Reports on Operation Allied Force: <http://www.defenselink.mil/pubs/kaar02072000.pdf>

Ministry of Defence: <http://www.mod.uk/>

Ministry of Defence Kosovo index page. Includes links to press conference transcripts and Lord Robertson's Account of the Conflict: <http://www.mod.uk.news/kosovo/index.htm>

Foreign and Commonwealth Office Homepage: <http://www.fco.gov.uk/>

French Ministry of Defence Lessons Learned Report on Operation Allied Force index (in French only): <http://www.defense.gouv.fr/actualites/dossier/d36/rubriques0.htm>

UNMIK (United Nations Mission in Kosovo) Homepage: <http://www.un.org/peace/kosovo/pages/kobanner.htm>

UNHCR (United Nations High Commissioner for Refugees) Kosovo Crisis Update Homepage: <http://www.unhcr.ch/news/media/kosovo.htm>

Humanitarian Community Information Center: <http://www.reliefweb.int/hcic/>

OSCE (Organisation for Security and Cooperation in Europe) Homepage: <http://www.osce.org/>

OSCE Mission In Kosovo: <http://www.osce.org/kosovo/>

OSCE Background Paper on Human Rights in Kosovo—As Seen, As Told: <http://www.osce.org/kosovo/reports/hr/index.htm>

Public Broadcasting Service (FRONTLINE): <http://www.pbs.org>

UNSCR 1244 United Nations Security Council Resolution 1124, 10 June 1999: <http://www.un.org/Docs/scres/1999/99sc1244.htm>

U.S. Institute of Peace: <http://www.usip.org>

Text of the Rambouillet Accords [U.S. State Department]: <http://www.state.gov/www/regions/eur>

Text of the Military Technical Agreement—9 June 1999: <http://www.nato.int/kosovo/docu/a990609a.htm>

International Criminal Tribunal for the former Yugoslavia Home page: <http://www.un.org/icty/index.html>

Human Rights Watch Report into Civilian Deaths in the NATO Air Campaign: <http://www.hrw.org/reports/2000/nato/>

Human Rights Watch Report—Kosovo: Rape as a Weapon of “Ethnic Cleansing”: <http://www.hrw.org/reports/2000/fry/index.htm>

Washington Post: <http://www.washingtonpost.com>

SECTION 6—COORDINATION AND INFORMATION SHARING

CHAPTER XXIX

Information Sharing in Kosovo: A Humanitarian Perspective

Molly Inman

The idea of information sharing among actors supporting complex emergency operations has been gaining favor for a number of years, but only recently has the technology become advanced, inexpensive, and widespread enough to make it feasible. The omnipresence of the Internet and the ever increasing use of geographic information systems (GIS) to analyze data have turned the notion of creating an information-sharing mechanism for complex emergencies into a reality. In the evolution of the concept of complex emergency operations, the mission in Kosovo has been on the cutting edge in many fields including information sharing. Though serious gaps in this aspect of the mission remain, they have become much more narrow over the course of the mission and are receiving serious attention. This chapter describes the information sharing efforts among the members of the international community in Kosovo and discusses the lessons learned from their experience.

Complex emergency operations are frequently beleaguered by poor coordination and cooperation that could be substantially improved if knowledge about conditions on the ground were made readily available in an organized manner for collective use. In the absence of information sharing, organizations must collect their own data on affected areas and as Maxx Dilley of the Geographic Information Support Team¹ notes, “[s]ome areas are never visited. Others are visited once and never visited again. Or, the same village may be assessed repeatedly (particularly along the main roads) to the point of potentially endangering the lives of the next assessment team” because the local population become frustrated by continually being assessed without receiving aid or seeing progress.² Such inefficiencies can be partially remedied by creating a mechanism to standardize and to coordinate the collection and sharing of information.

Information sharing in planning and executing complex emergency operations results in:

- Improved coordination of sectoral activities;
- Increased accountability;
- Improved program efficiency; and
- Support for a transition from relief activities to reconstruction and rehabilitation.³

Organizations know what data have already been collected and where there is a dearth, increasing efficiency and promoting coordination among collecting organizations. Once relief providers have analyzed the data, they know where supplies have been distributed and what areas have yet to receive any, resulting in better allocation of relief resources. The coordination of the assessment process and sharing of the results are vital because “grasping the totality of a complex emergency requires more information and understanding than most organizations can gather and analyze alone.”⁴ Organizations need not abandon their independent information collection and analysis processes. By coordinating what they will assess and sharing their results, all organizations can benefit from the more thorough and wider assessments while expending fewer resources.

Though the mission in Kosovo charted new territory in the realm of information sharing, the process still requires much improvement to operate at its full potential. An unprecedented amount of resources were poured into Kosovo by the international community, which as experience has shown, can actually hinder information sharing. In other humanitarian assistance operations such as the one in Mozambique, resources were so scarce that the international community including the U.S. military were required to share information and coordinate their efforts if they were to be in any way successful. In Kosovo, however, many agencies, organizations and NATO in particular, brought with them so many resources that information sharing and coordination did not appear as urgent. Much waste could have been eliminated from the outset had there been a functioning information sharing mechanism, especially one that conveyed to the international community which organizations and agencies had competencies in which sectors.

Accountability has also been raised as an issue that plagued the efforts in Kosovo. There are so many different actors working toward the same goal but with different perspectives and agendas. Without knowing what each organization is doing, none of them can be held accountable to the international community for their activities. Organizations rarely hide their activities, but few organizations have the resources to expend to find out what the other 400-plus organizations are doing. However, a mechanism that makes this information readily available encourages organizational peer-pressure, causing them to be self-regulating. An additional concern about accountability: once the information sharing mechanism for the humanitarian community was under development, no real verifying mechanism existed to prevent an organization from providing false information. It soon became evident, however, that if an organization did provide false or inaccurate data, that there was adequate expertise among the members of the humanitarian community to correct the problem. Were it to become a regular practice of a particular organization, that negligent organization would lose credibility.

Geographic Information Systems

In discussing information sharing for humanitarian assistance operations in general, including Kosovo, one must highlight GIS. This technology enables users to integrate location-based data sets and display them together to provide a more complete view of an operational environment. As the U.S. Geological Survey (USGS) defines it, “GIS is a computer system capable of assembling, storing, manipulating and displaying geographically referenced information...”⁵⁵ GIS displays information graphically to clarify the results of and allow for analysis by decisionmakers. All data must be geo-referenced so that the software can plot it on a digital map. In Kosovo, this was accomplished by assigning a unique place code (p-code) to approximately 2,000 populated areas. Fortunately, GIS technology has become relatively inexpensive and widely available, so that even smaller nongovernmental organizations (NGO) may afford it. Though developing the data sets and the parameters requires relatively highly skilled technicians to which NGOs may have limited access, they then have the incentive to coordinate more closely with larger IOs such as the U.N. to benefit from their technology staff. Once the information is organized, relief

personnel can manipulate it easily even with only limited training that can be delivered via a computer-based tutorial.

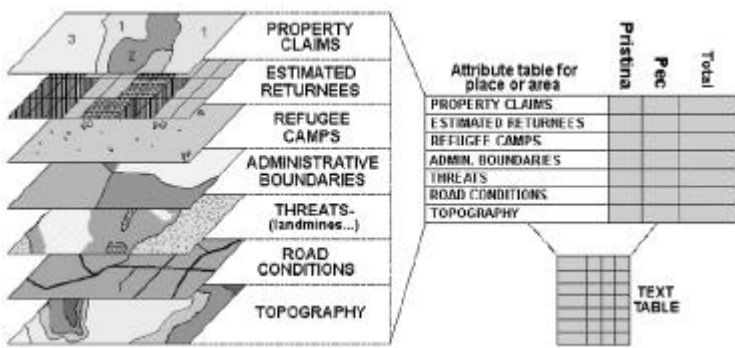

Figure 1. GIS for Repatriation Planning (from presentation by Dr. William B. Wood, Geographer and Director of the Office of the Geographer and Global Issues, U.S. Department of State, "Cross-Border Crisis Intervention: The Use of GIS in Kosovo")

GIS is also valuable to the information sharing effort in complex emergencies because it provides increased incentive for agencies and organizations to agree on a standard method of recording and collecting data. Few disagree that sharing information to support a humanitarian cause is a positive development, but the practical matter of getting them to agree on standard methods is daunting. The information sharing effort in Kosovo has been a pioneering one and will pave the way for future operations. However, even after 18 months, the parties involved are still working toward this goal. Nevertheless, the advantages of using and sharing GIS data are so readily apparent that organizations are committed to finding standards on which they can all agree.

Another advantage of GIS is its simplicity of use that makes it amenable to the often low-tech, chaotic field environment. GIS data can now be recorded and manipulated on a variety of devices including hand-held and ruggedized laptop computers that can be equipped with satellite communications capabilities. GIS data is also readily shared electronically, which allows it to be posted on a central Web site or shared via email or CD. The Internet allows organizations to access information instantly from locations all over the world. The CD allows organizations to use the data without access to the Internet. It is also a suitable format for sharing information that remains relatively

unchanged such as topography. Practitioners in the field can view and use the same information that their strategic planners at headquarters are using. Donors can also use this information to assess the progress in their areas of interest.

GIS is so valuable for use in humanitarian operations because it can enable the international community to assess the operational environment in aggregate. The problems and progress in various regions can be compared easily to assess the situation and assist decisionmakers. Clearly, GIS is not synonymous with an information sharing regime, but it does encourage actors to cooperate and lays the foundation for collaboration.

The Kosovo Experience

One of the first advocates of information sharing in Kosovo between the Kosovo Verification Mission (KVM) and the United Nations High Commissioner for Refugees (UNHCR) was the U.S. State Department which proposed the idea in October 1998 to Ambassador William Walker, KVM Head of Mission. The proposal focused on using GIS as the catalyst for information sharing. The KVM used GIS to identify the location of minefields and unexploded ordinance, and the UNHCR used it to record housing damage and the location of internally displaced persons. By combining these data sets along with the location of potable water, they were able to collaborate in better managing the resettlement process. Key to this process was the contribution by the U.S. National Imagery and Mapping Agency of the electronic base map and the fundamental data sets on roads, topography, place names, etc. The State Department's Office of the Geographer and Global Issues also contributed enormously, training both KVM and UNHCR personnel to use GIS. Unfortunately, the escalating violence in early 1999 that caused the withdrawal of the KVM halted the program. However, it could not eliminate the need for information sharing which would increase in the next iteration of humanitarian assistance in Kosovo.

Repatriation

In anticipation of the end of the NATO bombing campaign, the international community began in late spring of 1999 to plan for the eventual repatriation of over 750,000 refugees to the severely damaged province. Hoping that

this massive undertaking would be gradual, the Kosovo Repatriation Information Support (KRIS) program commenced and again was largely driven by the State Department in cooperation with UNHCR as well as the NGO community. The goals of KRIS were threefold:

1. To identify sources and availability of U.S. Government-supplied information relevant for safe repatriation of Kosovar refugees;
2. To build information management tools that allow repatriation managers to... use multiple sources of data for strategic planning and tactical operations; and
3. To ensure that as much useful information was shared with NATO, U.N., and NGO agencies involved in repatriation implementation.⁶



Figure 2. Kosovo: Reported Locations of Mines and Explosive Hazards (from Dr. William B. Wood, Geographer and Director of the Office of the Geographer and Global Issues, U.S. Department of State)

The UNHCR established a GIS unit in Pristina and worked with NGOs to develop a standardized Rapid Village Assessment form (RVA) for the relief organizations and KFOR to collect essential data on damage to

housing and infrastructure as well as population and civil society. This feat was a monumental accomplishment for the information sharing effort for complex emergencies. The data collected was relatively accurate and gave the humanitarian community a useful first look at what needed to be done. Resuming collaboration with UNHCR, the State Department sent a team to the Former Yugoslav Republic of Macedonia (FYROM) to begin using the data collected in planning for the coordination of repatriation activities. In addition to the RVA data, NATO flew U-2 sorties in early June to provide unclassified imagery of Kosovo which provided valuable information for the resettlement process as well. Though the spontaneous return of refugees foiled the international community's intention of orderly, planned repatriation, and thus precluded the use of the GIS data for advanced planning, the effort was incorporated into the Humanitarian Community Information Center (HCIC) in Pristina.

The Kosovo Humanitarian Community Information Center

The HCIC has been very successful in facilitating the sharing of information in Kosovo and will undoubtedly be used as a model for future complex emergency operations. It provides its services from the UNHCR building in Pristina while being staffed and resourced primarily by the United Nations Office for the Coordination of Humanitarian Affairs (OCHA) and is supported by the U.S. Agency For International Development, the UK's Department for International Development, Catholic Relief Services, International Rescue Committee (IRC), Organization for Security and Cooperation in Europe, World Food Program, and Save the Children. The Center provides the following services:

- Supplies a database of local and international organizations working in Kosovo;
- Gives practical advice and information of interest to the humanitarian community;
- Provides central bulletin boards;
- Provides agency mailboxes; and
- Promotes the free exchange of information.

Additionally, the center disseminates information through its Web page (www.reliefweb.int/hcic/), especially in the form of maps and geo-referenced data for which the codes have been standardized and are compatible with the two major commercial GIS software packages. One such software package is ArcExplorer, which is available for download online, free of cost from Environmental Systems Research Institute. Using these software packages, agencies can customize maps to meet their specific needs viewing data sets in any combination they wish.

The data sets are categorized into three groups depending on their source and accuracy. Those developed by the HCIC are derived from original Yugoslav Government documents and their coverage is limited to Kosovo. The data sets provided by the European Union are the most accurate geographically and contain the widest range of functional areas, but exclude small areas of Kosovo. The NIMA data sets have lower spatial accuracy than the other two groups but provide coverage of all of Kosovo as well as of neighboring Albania, Montenegro, FYROM, and Serbia-proper. The site also provides a short tutorial on how to manipulate these data sets. In addition to data sets, the HCIC also provides:

- An atlas of Kosovo;
- Planning maps for the regions of Kosovo;
- HCIC Kosovo Encyclopedia CD;
- Kosovo Rapid Village Assessment Data (discussed above); and
- U.N. agency reports.

One of the most useful items available on the site (which is still under development) is the “Who is doing what, where” information, which provides information on what organizations and agencies are working in what regions. Sharing this information not only allows for the better allocation of resources but also allows KFOR to assess in advance where they might be needed to provide security to members of the international community. Though sponsored by the U.N., the HCIC promotes and facilitates coordination not only among U.N. agencies but also among NGOs, IOs, KFOR and donors providing humanitarian relief in Kosovo.

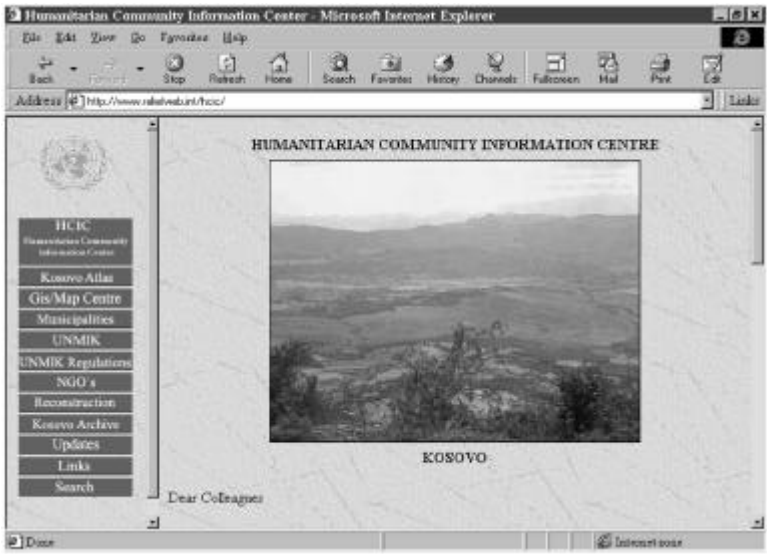

Figure 3. HCIC Web Site Main Page: www.reliefweb.int/hcic/

The Internet in Kosovo

Many of the services provided by the HCIC would not be possible without the presence of the Internet in Kosovo, and in fact, UNMIK is the first major peace building mission that has centrally integrated the Internet. After Serb forces withdrew from Kosovo on June 12, 1999, the international community had the enormous task of providing immediate humanitarian relief and long-term reconstruction and development for a badly damaged province whose infrastructure had not been well maintained or updated for many years before the conflict. During the NATO bombing, most of the telephone lines between cities in the province had been severed. As the international community returned to begin or to resume aiding the people of Kosovo, it brought with it exorbitantly expensive satellite phones and more affordable but less reliable mobile phones that depended on the Yugoslav company MOBTEL and its one small antenna in Pristina for service. A few residents of the province who had subscribed to Serbian Internet service providers before the war could log on, and the Grand Hotel in Pristina allowed clients to log on for 1DM per minute, which was beyond the means of most local people at the time. With so many organizations, agencies and individuals trying to coordinate the humanitarian effort

and begin the reconstruction effort, the Internet Project Kosovo (IPKO) was formed to begin to fill the communications gap.

The first proponents of this project were Teresa Crawford of the Advocacy Project and Paul Meyer of the IRC. Both agreed that the IPKO should “[g]ive the international humanitarian community an efficient tool that enables them to share information, coordinate their activities and communicate more efficiently,” as well as “[p]rovide free Internet access to key Kosovar institutions and build a lasting infrastructure for Kosovo’s Internet.”⁷ Because the telecommunications network in Kosovo was badly damaged and would require years to repair fully, the best solution for connecting Kosovo to the Internet quickly was via satellite. During the bombing, a company called Interpacket had loaned the U.S. humanitarian effort a satellite dish and 1 year of satellite time for the refugee camp in Stenkovac, Macedonia, which had been abandoned along with the camp during the spontaneous and rapid repatriation of the refugees to Kosovo. Meyer convinced Interpacket to move the dish and associated equipment to Pristina to be used to set up the non-profit IPKO. The IPKO team decided that the safest and most neutral site to install the equipment would be on top of the building being used for British KFOR Civil-Military Cooperation (CIMIC) personnel and enlisted the aid to the British Royal Engineers to ensure that the equipment received adequate electricity. IRC also procured the aid of MicroTik, a company based in Riga, Latvia to provide the necessary equipment and software to allow the network administrator to manage the network. As network administrator, the IPKO team pursued a Kosovar Albanian who was well known for his hard work, resourcefulness, experience, and strong commitment to rebuilding Kosovo, and finally persuaded him to join the IPKO initiative.

Though eventually successful, the IPKO team faced several hurdles in getting the service online: having to replace faulty parts, rewiring the electricity to the building in which it was housed, and trying to get the satellite to confirm its signal. The IPKO is now serving more than a hundred organizations including every U.N. agency in Kosovo, OSCE and most large NGOs, charging between 1500 DM and 2950 DM per month, depending on the type of connection, and is providing its services free of cost to Kosovar civic organizations. Eventually, the IPKO will be handed over to the people of Kosovo and will continue to provide Internet service to the local population for years to come.

Information Sharing and the Transition from Relief to Development

As the mission continues to transition from humanitarian relief to reconstruction and development, the HCIC has begun to support the other pillars of the UNMIK, specifically civil administration, institution building and reconstruction. The HCIC has been an excellent tool for supporting the humanitarian community and has the potential to have the similar of successes in promoting information sharing among the pillars. Though the pillars support the same mission, there have been significant instances of the lack of coordination. For example, an EU entity, the International Management Group, developed a \$5 million database that employed over 60 staff, but it would not submit to U.N. standards to ensure compatibility and refused to share its data with the U.N. until just before the EU phased it out.

Though the HCIC was originally envisioned as a permanent institution to support relief, rehabilitation, reconstruction, and development in Kosovo, there was no formal, guiding plan until the gradual elimination of the humanitarian pillar prompted the drafting of one. The three objectives are prioritized in this initial document are:

1. Expand and strengthen institutional linkages particularly with UNMIK and Kosovar NGOs;
2. Establish a non-binding Advisory Board to provide guidance on policies and practices; and
3. Expand information gathering, management and dissemination systems.⁸

Though the HCIC will continue to facilitate information sharing among the members of the international community, it also plans to reach out to local NGOs to support capacity-building efforts and to become institutionalized within the community. Specifically, the HCIC is pursuing efforts to make its services and resources available in the local languages and is promoting the HCIC as a neutral meeting place to help to reduce the gap between local NGOs and the international community.

The document also lays out four scenarios for potential management structures for the HCIC. The first maintains the status quo having the HCIC remain under the Humanitarian Coordinator's Office and continue

to be funded by OCHA. Though it would continue under its current name, it would be not only of service to those in the humanitarian community, but would also support reconstruction and development activities. The second and third scenarios incorporate the U.N. Development Program (UNDP). The second would give the responsibilities of the Humanitarian Coordinator to the Development Coordinator, but the HCIC would retain its name and some OCHA funding for its functions associated with the humanitarian community. The third specifies that the duties of the Humanitarian Coordinator be eliminated and the HCIC be placed under the UNDP that would necessitate a name change to indicate to the community its change in focus. The fourth scenario places the HCIC under an UNMIK department or pillar, relieving OCHA of its administrative and financial responsibilities. This question, however it is resolved, will inform planning efforts for future operations.

Two more innovations that are aimed at improving in the information sharing effort in Kosovo are the formation of the Information Group (IG) and the creation of the position of Chief of Information Coordination (CIC). The purpose of the IG is:

- To provide relevant information to be shared over the Internet;
- To promote existing standards and the development of new ones;
- To develop guidelines for information sharing; and
- To create a mechanism for cataloging databases and providing appropriate access to legitimate users.

It is a voluntary group composed of information managers, consumers and providers in Kosovo. Though the IG aims to serve the whole community contributing to the effort in Kosovo, it especially focuses on supporting the information requirements of the pillars of UNMIK, the Joint Interim Administrative Structure, and regional and municipal administrators. The CIC, being assigned to the UNMIK chief of staff's office, will act as a member of the strategic management team and will generally help to set information sharing policy for the mission and liaise with the IG and other entities on information issues within the community. Among the CIC's many specific tasks are:

- Managing the information process through the shift from peacekeeping to development;
- Developing measures of effectiveness for efforts to harness information technology in Kosovo; and
- Communicating lessons learned to the U.N. and other organizations that are likely be involved in supporting peace operation in the future.

While the CIC will be an element within UNMIK, the IG is intentionally less formal to give it flexibility and independence as well as to attract the participation of entities that may be wary of associating with a formal U.N. agency. It will clearly be vital for the CIC, the head of the HCIC, and the IG to coordinate and communicate about their activities.

KFOR CIMIC Contribution

The reviews have been mixed about KFOR and its contribution to information sharing in Kosovo. KFOR has had the onerous responsibility of establishing and maintaining security in the region and understandably would not want to participate in any activity that may compromise its ability to accomplish this mission. However, it has been criticized heavily for restricting the release of essential yet innocuous information. During the spontaneous repatriation of refugees in Kosovo, those in the humanitarian community recognized the danger of unexploded ordinance to the returning civilian population. NATO was reluctant to release this information and stalled until pressure from the humanitarian community forced it to release it or suffer a public relations embarrassment.

Since that rocky start early in the mission, KFOR CIMIC and the international community have improved their relations and developed strong working relationships. One of CIMIC's significant contributions to information sharing is its daily situation report that was written for Supreme Headquarters Allied Powers Europe (SHAPE) but was invaluable to the international community. The CIMIC officers assimilated information from unclassified sources and became brokers of information, creating a dialog among KFOR, UNMIK and the NGOs. Unfortunately, during summer 2000, SHAPE decided that the information being released was too sensitive (though it was derived solely from

unclassified sources) and halted its dissemination. One CIMIC officer expressed his frustration with the decision, explaining that many in the international community relied on that report for information on the security situation and the blocking of its release lessened CIMIC's credibility and went directly against its objectives. Eventually, the situation was resolved by allowing the release of the situation reports, but limiting it to the local international community on the ground.

Lessons Learned

In general, the feedback on the information sharing effort within the international community in Kosovo thus far has been positive, but there are still several areas in which it could be improved. In comparison with other contemporaneous humanitarian operations, the contributing nations have spent lavishly and with so many resources being poured into the province, there needed to be better coordination to ensure equitable distribution. The following is a compilation of lessons learned from various sources and agencies in the field about the information sharing efforts in Kosovo.

U.N. Mission:

- All planning and equipment needed for an information-sharing mechanism must be in place from the outset. "Incremental, ad hoc implementation simply means that the information and products are always behind schedule and unavailable when they are most needed."⁹
- Have an information plan for the mission that establishes an authoritative civil-military coordination mechanism. The absence of such a mechanism has led to redundancy, lapses in coverage, and wasted information. The HCIC has performed well as the coordinating mechanism among civilian humanitarian organizations, however its coordination with KFOR on information issues has been spotty. The mission would have benefited from having an information plan constructed with the input of the military, the international organizations, and NGOs to ensure that their interests and concerns were addressed.

- The Internet is an excellent medium to communicate information and it should be developed for data and document exchange with public access.¹⁰
- Because of the high turnover of both civilian and military staff, the relationships among them need constant attention to be maintained.
- Though there has been much focus on the technological elements needed to improve information sharing, it is important not to abandon or ignore face-to-face “soft” information sharing which often enables the sharing of “hard” data by establishing trust among the different actors.

GIS:

- “Staffing and equipment needs for the GIS unit must be adequately anticipated and met to ensure an ability to meet increasing demand for data collection and mapping services.”¹¹
- A base map must be prepared ahead of time. Often in regions where complex emergencies erupt, the information needed to develop an adequate base map which shows topography, regional borders, district borders, and other semi-permanent features is lacking. Even once this information is obtained, creating the base map is time consuming. Policy makers must anticipate potential complex emergencies and devote resources to gathering information ahead of time.
- The response time of an information sharing mechanism must be improved. GIS data sets are particularly useful at the start of a humanitarian mission before many intervening organizations and agencies have first-hand knowledge of the area. The agency or agencies that assume leadership for an information sharing mechanism need to develop a surge capacity to respond immediately to an unfolding disaster.
- Data collection must be standardized. The rapid village assessment form paved the way for standardized data collection in Kosovo. Had different criteria been used to collect and measure the data, it would have been incompatible and impossible to compile into meaningful data sets. However, the RVA form itself became somewhat of a problem in that often they

were incomplete or illegible, leading to a less accurate assessment. New technology can allow data collectors to take ruggedized computers and hand-held computers into the field to record data in an electronic format and then upload it to their central systems via satellite connections or after they return from the field.

KFOR:

- More professional military education needs to be devoted to peacekeeping operations. Many of the decisions from headquarters about CIMIC information sharing demonstrated their lack of understanding about CIMIC. Military education is still focused on educating officers to fight the next Gulf War and, therefore, leaving them unprepared to make informed decisions in the missions the military is actually facing and will continue to face. It is generally a significant challenge to obtain the trust and respect of the international community when it comes to information sharing in a peace operation and transparency is key to overcoming this challenge. KFOR CIMIC had been using their daily situation reports to win the trust of the other intervening actors in the region when the plug was pulled. Even were it to start releasing them again, it will take time to regain the trust of the humanitarian community.
- More is often less; keep it simple! The resources poured into the mission in Kosovo are unprecedented in comparison with other contemporaneous peacekeeping missions. Unfortunately, having so many resources massed has discouraged the military from having to share information and has encouraged it to seek complicated solutions. In operations with less funding, the military had to work with the international community and share information using local resources and open sources. In Kosovo, however, KFOR expends many resources to collect classified intelligence that often the international community already knows.
- Bilateralism hurts unity of effort. With a mission as highly publicized as the one in Kosovo, it is understandable that nations contributing forces to KFOR would want to get positive media coverage to maintain domestic public support in their own countries. However, many have noted that attempts to receive

positive media coverage results in negative effects upon unity of effort among the MNBs.

The Internet:

- “The Internet cannot function in a vacuum. It needs money...electricity, and a legal and administrative framework.”¹²
 - The IPKO team faced all of these obstacles. Though they received generous loans and donations from various sources initially, donors eventually become less enthusiastic and their funds are always limited. To address this issue, the IPKO decided to charge the international community for its services to recoup its costs, while providing their service free of charge to the local population.
 - Electricity was also an obstacle initially. Two power plants that were in previously in poor condition and had been damaged during the bombing were supplying the entire province with electricity. There were often power outages and power surges, which the highly sensitive high-tech equipment could not tolerate. To overcome this obstacle, the IPKO team had the whole room housing the server rewired and connected to a generator that would provide power to the project automatically in the event of a power outage. They also installed several Uninterrupted Power Sources (UPS) to protect against power surges.
 - Signing the MOU was key to giving the IPKO the authority to provide its services. In the post-conflict environment, there was no functioning legal system, leaving ambiguity about what laws still applied in the province. By signing the MOU with UNMIK, the IPKO established its legitimacy.
- It is important to make certain the system benefits the local people in the long-term and not just the international community in its relief efforts.
- An appropriate organization must be chosen to develop and administer an ISP in post-conflict situations. The International Organization for Migration, whose main function is to transport refugees, was tasked by the U.S. Information Agency to provide

Internet connectivity to refugees at the refugee camp in Stenkovac, Macedonia, but it lacked the expertise and capability to make this effort a success.

Acquiring data:

- Any information sharing mechanism must solicit information; it cannot just wait for NGOs and IOs to come to it with data sets.
- In that same vein, it must be worth an organization's time and effort to share information; for example, for cooperating with the information sharing mechanism, they receive communications capabilities for free or at a reduced rate, or have donors require the sharing of information or rescind funding.
- It must be acknowledged that some organizations will never share certain kinds of information. They cannot be forced to do this, but it is valuable to know what information they will not share.
- At some level, information must be analyzed and given some meaning.
- KFOR is an untapped source of information, especially at the brigade level.¹³

Conclusion

The process of sharing information in Kosovo has been very successful and continues to evolve. Future operations will undoubtedly do well to replicate these efforts, but one hopes that they will also give some attention to its lessons learned. The HCIC has revolutionized information sharing among the members of the international community with its formal mechanism. Advances in technology also continue to facilitate information sharing in Kosovo. The U.N. is beginning to recognize that the requirement for sharing information in complex emergency operations necessitates the creation of a position under the chief of staff for a Chief of Information Coordination. Additionally, the CIMIC community, perhaps more than any other group, has recognized the need to share information and has worked hard to fill this need, laboring to overcome limitations placed on it from higher up in the

NATO command structure. With so many entities working toward this same goal, the international community will continue to narrow the information gap and work toward more effective information coordination for complex emergencies.

¹The Geographic Information Support Team is an informal technical team comprised of geographic information focal points from the United Nations and donor agencies with disaster management and humanitarian assistance mandates.

²Maxx Dilley, "Structured Humanitarian Assistance Reporting (SHARE): Description and Requirements for Georeferenced Data Collection and Mapping to Support Humanitarian Assistance Operations," USAID Office of Foreign Disaster Assistance, 1999: p 3.

³Maxx Dilley and Nate Smith, Cable summarizing the findings of their December 1999 visit to Kosovo.

⁴Charles J. Jefferson, Ph.D., "Information Dissemination and Use in Complex Emergencies," U.S. Department of State, 1998: p. 3.

⁵United States Geological Survey, "Geographic Information Systems," <http://www.usgs.gov/research/gis/title.html>, 2000.

⁶Presentation by Dr. William Wood, "Cross-border Crisis Intervention: Use of GIS in Kosovo," at the U.S. Institute of Peace, November 17, 1999.

⁷Internet Project Kosovo, <http://www.ipko.org>, 2000.

⁸Office of the Deputy Social Representative of the Secretary-General to Kosovo for Humanitarian Affairs, "The Humanitarian Community Information Centre, Strategic Planning: June to December 2000 and Beyond," U.N. Interim Administration in Kosovo.

⁹Maxx Dilley, "Structured Humanitarian Assistance Reporting (SHARE): Description and Requirements for Georeferenced Data Collection and Mapping to Support Humanitarian Assistance Operations," USAID Office of Foreign Disaster Assistance, 1999: p.14.

¹⁰Office of the Deputy Social Representative of the Secretary-General to Kosovo for Humanitarian Affairs, "The Humanitarian Community Information Centre, Strategic Planning: June to December 2000 and Beyond," U.N. Interim Administration in Kosovo, p. 11.

¹¹*Ibid.*, p. 3.

¹²United States Institute of Peace, "The Internet and the Kosovo Humanitarian Crisis," The Internet Project Kosovo, <http://www.usip.org/oc/vd/vdiplo-share/ipko.html>, 2000.

¹³Office of the Deputy Social Representative of the Secretary-General to Kosovo for Humanitarian Affairs, "The Humanitarian Community Information Centre, Strategic Planning: June to December 2000 and Beyond," U.N. Interim Administration in Kosovo, p. 10.

CHAPTER XXX

Peace Support Operations Cooperation, Coordination, and Information Sharing: Lessons from Kosovo

Larry Wentz

A Matter of Political Will

Increased civil-military involvement in peacekeeping and humanitarian operations around the world is matched in part by the escalation in the number and complexity of these operations. The need to improve cooperation, coordination, and information sharing is on the rise. There are many more actors in today's peace maneuvers than ever before. They have competing as well as common interests and expectations. These peacekeeping efforts must overcome a continuing lack of trust among the disparate participants, and differences in their cultural traditions and behavior patterns. All actors need to understand each other and the roles they can and should play better. They must develop relationships based on mutual trust and recognize that change is a two-way process.

Since no two operations are really the same, one should be careful about generalizing too much about the lessons learned. Nevertheless the experiences of previous operations can give the community a higher level of awareness and facilitate the tailoring of responses to meet the needs of a new operation. Still, even demonstrated changes for the better were not necessarily applied to the challenges of Kosovo. For example, despite extensive Bosnia experience, communications and information-system interoperability continued to be problematic. This state of affairs created security breaches and inconsistent awareness of shared situations.

One should also realize that we were lucky in Bosnia and Kosovo. Even though ground operations in both Bosnia and Kosovo were essentially unopposed and given the overwhelming force of NATO air power, conflicting political, diplomatic, military, and legal pressures compromised the air war. These pressures threatened to tear apart the alliance. One has to wonder whether NATO could maintain its political will, the solidarity of the alliance, and its combat effectiveness in a real shooting war, with casualties.

Although information-sharing progress has been made in Kosovo by means of local collaboration and information technology driven initiatives, there is still much more to do to meet the needs for cooperation, coordination, and information sharing. The Balkan experience highlights the urgency for improvement. This, coupled with the information technology revolution, offers an avenue of approach. It is, however, a matter of political will rather than a technology solution. Technology will be only an enabler.

Setting the Stage

Peace Operations: "...All mischief short of war."

—Sir Winston Churchill

The patterns of conflict in the post-cold-war environment have been changing. The traditional peace operation environment in which combatants signed an agreement in good faith and asked a body like the United Nations (U.N.) to serve as a neutral observer looks to be a thing of the past. The Balkan experience could lead one to doubt the true intentions of parties to a peace agreement in today's world. It is no longer clear whether the parties have signed to work together to achieve a peaceful settlement or whether they are using this as a way to buy time to regroup and pursue their goals by other means, including violence.

Earlier peace operations were primarily military, with possibly a small police contingent. More recent operations have involved relief and reconstruction teams, election supervision personnel, and multinational civil administration staffs, as well as larger police contingents. Instead of monitoring a cease-fire line, the intervention force is likely to have a much broader mandate. Actions are likely to include disarming belligerents and cantonment or destruction of their weapons, arresting

suspected war criminals, distribution and protection of humanitarian aid, civil infrastructure reconstruction, nation building, and assisting and protecting the resettlement of displaced persons. As a result, the requirement for a more integrated and collaborative civil-military involvement is becoming critical in an environment that is becoming increasingly difficult and dangerous for the peacekeepers.

Many conflicts no longer take place between states that are strong enough to conquer one another but within nations that have become so weak they collapse. “Wars of the amateurs” occur where the population coalesces into identifiable factions. Disintegration of public law enforcement and the military and other security forces occur concurrently. The armed amateurs use the full range of conventional weapons for unconventional operations, such as scorched-earth actions, ethnic cleansing, terrorism, and intimidation of local inhabitants (see Figures 1 and 2).



Figure 1. Kosovo Church Bombing



Figure 2. Over 800,000 Kosovo Albanian Refugees

Political factions with their own agendas led by charismatic leaders work on minority fears and ancient grievances. Many refuse to be held accountable for their actions. There are no clear front lines and rear areas, but are instead fluid zones of conflict. There are wide extremes of weather and terrain, and a mix of urban and rural, modern and primitive, upscale and slum locales. Transportation routes are inadequate, and massive problems develop from displaced persons and destroyed infrastructure. Such was the case for the Balkans.

Post-conflict reconstruction and nation building have changed as well. The financial and other resource commitment of donors and other nations are uncertain. A year after the U.N.-led Kosovo intervention, supported by the OSCE, E.U., and NATO, pledges for financial assistance made at the outset by international financial institutions and nations have as yet to fully materialize. Clear political objectives and end states and definitions for successful interventions and resolution of conflicts rarely exist. For instance, there is still no internationally agreed upon Kosovo strategy and plan to guide the efforts. There was no civil administration or law enforcement infrastructure when UNMIK and KFOR were deployed. It was essentially a “Wild West” environment—and to some extent it still is a year later. Power, water, telecommunications, and transportation infrastructure was lacking or in poor condition and is only slightly better now. There was little desire on the part of the Kosovar Albanians and Serbs to work together to rebuild the country, and that remains true today.

The challenges facing UNMIK and KFOR were enormous. The Kosovar Albanians openly supported continued international presence since it provided the cover for their continuing efforts towards independence. The Serb position was equally transparent. They continued to oppose Kosovar independence and denounced the international presence as a basis for it. Kosovo was not Bosnia. It was not an internationally recognized state, and unlike Bosnia, no final political solution like the Dayton Accords had been applied. As long as the fundamental question of Kosovo's status remained undecided, there was the possibility of the continuation of violence and, at best, a complete freeze on Albanian and Serbian political interaction. UNMIK and KFOR were committed to a multiethnic society, albeit in a place where the demographic, linguistic, religious, and cultural realities made the pursuit of this goal a practically futile effort. The future of the next generation, who were being influenced by present events and indoctrination, may already have been sullied.

Complex Dynamics at Work

Understanding the relationships and motivations of the players on the peace operations battlefield requires an understanding of the complex dynamics at work. The emerging need for stronger civil-military relationships and for cooperation are influenced not only by the political context and conditions of the operations but also by the shared moments of the participants on the ground. The decision to intervene in a conflict is political. The military mission in support of the intervention reflects the political process.

Military support to such operations is just that, a military operation. The military's function is to create a safe and secure environment. In Kosovo, KFOR soldiers guarded Serb enclaves and churches (see Figure 3) and escorted those Serbs wishing to leave the enclave to travel to Serbia or elsewhere, for shopping and medical treatment.

The military also provides assistance as appropriate and necessary to the International Organizations (IO) and Non-Governmental Organizations (NGO). They are not there, however, to do the jobs of these organizations.



Figure 3. KFOR Guarding Church

The essence of the military's might is its credible coercion. Credible coercion prevents would-be instigators from disrupting humanitarian efforts. The military's presence also promotes the healthy, daily, and political life of the country, and can raise expectations of afflicted peoples. On the other hand, there is the downside risk that such presence may delay stabilization, or create tensions once the situation is stabilized. Potential adverse consequences need to be carefully managed by the senior civil-military leadership on the ground and factored into the initiatives taken by the military supporting them.

The process of establishing security and restoring sufficient stability in order to address humanitarian needs is therefore inherently political. Humanitarian intervention may not be a bloodless exercise nonetheless. Labeling efforts as peace operations, plus a lower threshold for responding to violence, can create false perceptions and imply a casualty-free procedure. Senior political leadership, not only when assessing the need for the use of credible coercion, but also after the forces are sent in, must recognize the on-the-ground risks of such

operations. These risks need to be clearly articulated to the public from the outset, and the communication with the public must continue throughout the operation—especially since public interest in peace operations can be rather short lived.

Force Protection

For extended operations, such as in the Balkans, the tolerance for casualties on the part of the public decreases as time passes and complacency sets in. Therefore, the risks in general become less obvious to the public. Complacency is also something the military on the ground may experience, and needs to be carefully managed over time. If the resident population is not kept adequately informed throughout the intervention period, and do not openly support the operation, then the deployed forces can become a target, sometimes as a possible means of forcing a national policy change. The public does not like nor does it react well to surprises, especially if the loss of life of a soldier in a peace operation is involved. The withdrawal of U.S. forces from Somalia was an example of a political response to a public reaction, and may have shaped the U.S. military force protection policy for some time to come.

A complaint about the U.S. military support in the Balkans often heard from civil and non-U.S. military peace support elements, particularly the U.K. Army elements, is that security is an end in itself, rather than an enabler of broader humanitarian goals. It should be noted that a military commander's first priority is to bring the troops home safely—recognizing that the realities are such that some may not. A potential problem arises when casualties become politically intolerable. Such a political impetus can overly enhance a commander's desire to bring one's troops home safely, and can be amplified to the point of distortion.

Defense of the protective forces can develop into the paramount concern. One might argue that this has become the case for U.S. forces in the Balkans. Kevlar helmets, flack vests, the carrying of loaded weapons, and the use of multiple vehicle convoys for movement around the U.S. sectors in Bosnia and Kosovo are still the norm (see Figure 4). This is not generally true of the other sectors—nor of the rest of the international military and NATO headquarters contingents supporting operations in the Balkans (see Figure 5).



Figure 4. Author with Civil Affairs in Vitina



Figure 5. Non-U.S. KFOR Soldier

Because of the perceived surface-to-air missile threat, most allied air operations were conducted above 15,000 feet during Operation Allied Force in order to keep sophisticated and expensive aircraft, pilots, and crew out of harm's way. UAVs were used extensively in support of the air war and the cease-fire compliance and peace operation missions. Although more than a couple of dozen UAVs were lost due to enemy fire or crashes, allied leaders countered criticism about the heavy losses by citing zero pilot deaths or injuries. Nevertheless, some have pointed out that operating at the higher altitudes affected the accuracy of the bombing campaign.

The height from which the bombs were dropped notwithstanding, nobody should expect 100 percent accuracy from any bombing program. Furthermore, although referred to as the first video war and despite the media hype that raised expectations for weapon system precision, not all the weapons employed were precision guided and Operation Allied Force was not a video game. It was war in its most traditional sense, in which unintended consequences unfortunately transpire. For example, civilian casualties occurred as a result of allied bombings. There were other incidents, such as the accidental bombing of a refugee convoy in Kosovo and of the Chinese embassy in Belgrade. Even during the peace operation, regrettable accidents were occasioned. One such incident was the inadvertent shooting of a young Albanian boy in Vitina by a KFOR soldier. Moreover, in spite of extensive KFOR force protective measures, there were ground operation casualties caused by land mine explosions. Peace operations can be just as dangerous as war.

Self-Interest and Accountability

Contrary to popular belief, giving humanitarian aid is political. Supplying aid may not always be the right remedy for a given situation in a peace operation. In some instances, it can worsen the humanitarian crisis. This is especially true if the aid is not coordinated and managed properly. For example, food can become the currency of political power. As a result, the control and distribution of food can become a locus of local power politics.

Uncoordinated and competing humanitarian assistance efforts serve to exacerbate the difficulties in any given operation. Well-intentioned local military or NGO actions that are not properly synchronized with the broader International Organization led effort can and do cause

problems. Despite their traditional apolitical stance, NGOs are political as well. They have their own reputations, agendas, and spheres of activity to maintain. In fact, all actors on the peace operation battlefield, including the participating nations' civil, political, and military elements and the International Organizations, such as the U.N., OSCE, E.U., and NATO, have their own self-interests. The challenge is to coordinate and leverage these interests for the good of the whole.

Most—but not all—of these organizations are accountable for the consequences of their actions. Like it or not, the civil-military leaders in the field, through their actions, create and establish policy—whether there is a clear, internationally agreed political strategy or not. The NGOs, on the other hand, have more varied interests, tend to be less structured, and operate autonomously. As a result, in many cases, they are less likely to be held fully accountable for their actions.

There were a lot of good Samaritans trying to provide aid during the Bosnia and Kosovo operations. In Bosnia, there were more than 500 NGOs already in the country when NATO and elements of other International Organizations, for example, the Office of the High Representative (OHR) and the OSCE, arrived. At the outset of the Kosovo operation, there were over 300 NGOs in addition to the KFOR troops and U.N., OSCE, E.U., and other personnel. All of this activity took place in an area about the size of Connecticut. Attempting to help and coordinate the humanitarian efforts was a monumental task for both the International Organizations and NATO force parties—which they some times referred to as “herding cats.” It is obvious that the civil-military actors, including the NGOs, must improve their collegial awareness and understanding of the political aspects of the peace operation environment, as well as of the myriad ramifications of the actions of all of the participants.

Shared Understandings

To the plus side, no matter how complex the situation, there always seems to be a common understanding of the nature of the situation among the players on the ground. The challenge is to translate this common understanding to a shared vision and strategy, and to make sound plans. However, no two situations are ever really the same and it takes time to determine the requirements of each situation, to understand the dynamics that expedite or impede goals and to assess the

comparative advantages of the participants. It is also imperative to figure out how the different organizations fit together in the grand scheme of things. Ideally, these appraisals should be completed before the operation begins; but this is rarely, if ever, the case. Instead, the process is more episodic and evolutionary.

In terms of traditional roles, the military is more than likely to be frustrated with the ambiguous nature of the political process and political end state. (Political processes and political end states always will be fuzzy). And the civilian side will tend to see the military as being too rigid. Both will be suspicious of each other's true intentions. The realities are that the military bring to the table an infrastructure that provides communications, logistics, and security, and the civilian side brings humanitarian expertise, familiarity with the affected area, and sustained commitment. Both need each other—and in the end, success in the civilian arena provides the military with its “ticket” to go home.

Additionally, there are pressures to elevate the military to the dominant role at the outset of peace operations, or at least until a credible civilian organization can be instituted. If the military are put in this position and if the civilian organization does not step up to its commitments promptly, there is the danger that the military will either leave too soon or stay too long. The military will also be enticed into taking on responsibilities that the civilian agencies should be in charge of, because it has the infrastructure in place to do so. This is precisely what happened to the NATO-led Implementation Force (IFOR) in Bosnia due to the late arrival of the Office of the High Representative (OHR) and its staff. By default, the military performed services it would not normally have done, and then it was expected to continue to do them after the arrival of the OHR. In Kosovo, the U.N. asked KFOR to help to bridge the gap until UNMIK could get established and assume its appropriate responsibilities. As a result, there was a much better working relationship between UNMIK and KFOR from the outset of the operation. “Mission creep” was not part of the KFOR vocabulary in Kosovo. Still, KFOR continued to be used to plug the holes in the UNMIK civil capabilities, and this needed to be managed carefully.

Blurry Organizational Arrangements and Strategies

In Bosnia, the establishment of the OHR and other International Organization elements occurred significantly later than the NATO military

force deployment. In addition, the OHR was not given the overall authority that was required to direct and synthesize multiple civil and military actions. The NATO-led IFOR did not report to the OHR. The OHR was not a U.N. Special Representative, with U.N. authority, since the U.N. was reluctant to play a lead role as a result of its UNPROFOR experience. In fact, there was no internationally recognized political organization to provide the ultimate leadership, and this hampered synchronization of civil-military activities. As a consequence, the actors operated autonomously, within a loose framework of cooperation, but without a formal structure for developing unified policy and effort on the ground.

In Kosovo, UNMIK tried to advance. It implemented a four-pillar structure under its leadership:

1. UNHCR—Humanitarian assistance
2. U.N. Civil Administration - Districts, UNIP, and judiciary
3. OSCE—Police schools, media, and elections
4. E.U.—Reconstruction investments

This was a first-ever civil administration operation for them, however, and the procedures were inadequate to the task. Although KFOR was a military success and the UNMIK organization showed good potential, there was an absence of a clear international vision and uniform strategy and plan for Kosovo. For one thing, KFOR was asked to supply humanitarian assistance on a prolonged basis. In some cases, there was a lack of UNMIK authority for directing and synchronizing activities of the civil-military players, which frustrated its achievements. KFOR had its own reporting chain and COMKFOR was not the U.N. Force Commander. Despite these difficulties, the early collaborative efforts of UNMIK and KFOR resulted in some progress being made after 1 year. Nevertheless, achieving stable civil administration and rule of law in Kosovo remains a significant challenge.

Unfortunately, the more complex the situation, the less likely it is that a shared vision and common strategy will emerge. The implications for not achieving success are enormous. One might conclude that this is the state of affairs in Kosovo, and hence, question the likelihood that nations will take the risks and employ the resources necessary to rebuild

with any speed. Some argue that a cooling-off period might be advantageous before trying to pursue more ambitious reconstruction efforts. In any case, the decisions of the on-the-ground leaders always will carry a lot of weight, and they always will collectively be creating policy. Therefore, they must be empowered by their respective headquarters and nations to act with wide latitude. Enlarging on their presence and understanding offers at least *de facto* governance and unity of vision, which can guide near-term efforts.

The personnel rotation policies of the military, International Organizations, and NGOs unfortunately add uncertainty to a conclusion in the Balkans. For example, KFOR commander and staff turn over about every six months, including the Multinational Brigade commanders, staffs, and multinational units assigned to them. At the end of one year in Kosovo, there was not only complete military turnover but there was also a sizeable turnover of some of the nonmilitary organizations such as UNMIK police and U.N. civil administration staff. This means major continuity and coordination problems. The loss of institutional knowledge introduces unneeded obstacles to achieving and sustaining a stable operation. In Kosovo, UNMIK also suffered from an unusually high turnover of staff throughout the first year of operation. There was also a lack of skilled staff willing to fill key vacancies. The military-exit strategy in Kosovo is directly tied to the success of UNIMK. The limited progress to-date suggests that the military and International Organizations may be there for some time to come.

Mindsets Need Changing

The foregoing discussion leads one to the conclusion that all parties need to work hard at coordination and cooperation, because complete agreement may never be achieved. The old mindsets of the players need to be altered. The linear, military mindset is unsatisfactory for the task, and the NGOs, in particular, need to ameliorate their stance of total organizational autonomy, which promotes a behavior of do-what-we-want, when-and-where-we-want. NGOs compete for funding and seek visibility for their donors. Therefore, their actions can be closely tied to media coverage of a particular operation. This link between publicity and funding ultimately impacts the extent of NGO participation and continued presence in the area.

Luckily, there are a number of NGOs that are focused on providing grassroots, primary relief, and are committed for the long term. NGOs are usually on the ground before the military arrive, remain during its presence, and stay after it leaves. Hence, the military needs to be prepared to deal with NGOs upon arrival as well thereafter.

The U.N., like the NGOs, needs to discard old, bureaucratically oriented politics, a turf-guarding corporate culture, and lingering anti-military perceptions and behavior. It needs to cast off fears that its power, security, and prestige will be sacrificed if it makes compromises.

To obtain the integrated response required for the future, some tough, institutional culture and organizational behavior changes will be necessary. Although full cooperation is the goal, in the end, limited partnerships may be the best that can be achieved for some time to come. This is especially true of the NGO community, who do not operate within either the military or the governmental hierarchies.

A Reality Check

Fortunately, when present on the scene, many of the higher-echelon, institutional attitudes have less effect, since the emphasis is on problem solving, making things happen, and personal relationships and assistance. These operations place tremendous physical, emotional, intellectual, and spiritual demands on the players. Individuals who have worked in these efforts frequently recall how meaningful their participation was, and in spite of their political orientations, organizational perspectives, and insular visions and core values, that they as individuals were in it together. Both the civilian and military staffs are dedicated, selfless, professional people, who work eighteen-hour days under extreme conditions, making life-and-death decisions. Many of the participants view peace and humanitarian assistance not as a profession, but as a calling. For the military, tactical decisions and action can have immediate, strategic and national, political implications—the emergence of what is called the strategic corporal. These are endeavors that one eats, drinks and sleep, and they can have tremendous wear-and-tear on body and soul. As in war, friction is ever-present and needs to be dealt with quickly.

Information Superiority—or Not

There are cases where coalition military actions such as air and naval operations may need to be done in support of a civil-military ground intervention. For example, the NATO-led Operation Allied Force air war over Serbia enabled the UNMIK and Kosovo force (KFOR) intervention. These types of military operations are highly structured and use the latest information technologies to meet intelligence, situation awareness, and command-and-control demands.

In the air war, information superiority allowed NATO to acquire excellent battlefield information. This provided intelligence to assist weapon targeting and the opportunity to deploy more advanced weapon systems. The latter included command and control platforms and precision-guided munitions that locate and destroy targets.

However, not all of the high-tech systems functioned perfectly all of the time. For instance, some were unable to operate under the poor weather conditions that prevailed during the early phases of air operations. There were other issues: As in the ground operations, the human element was an important factor. The planners and users of the information were not always adequately prepared. NATO analysts did not always have a complete understanding of the information.

Furthermore, there were coalition information-sharing problems. These were associated with situation awareness and dissemination of air tasking orders. In some cases, too much information created information overload for commanders and their staffs. In spite of NATO's near-total information superiority, its battle space awareness was manipulated by Serb armed forces more often than was expected. Serb military interception of some NATO in-the-clear communications and allegations of internal leaks of sensitive military information raised concerns about coalition information security and the ability to protect time-sensitive military operation information.

Some Information-Sharing Challenges

Coalition information sharing has multidimensional issues, ranging from technical and procedural to language and culture. There are also policy and doctrinal considerations. As was noted earlier, at the outset, policy, vision, and strategy to guide civil and military, intervention-planning

activities in the Balkans were vague. Internationally agreed-upon policies and doctrines for conducting peace operations are still evolving. KFOR was deployed to impose order and to prevent ethnic violence. But they soon found out they were in a policing operation, requiring them to deal with things such as organized crime and other law enforcement activities. Policing is a civil function, but there was no civil judicial, policing, or administration bodies at the beginning of the operation, nor was there an equivalent U.N. or other International Organization provided capability. As a result, the military found itself in the position of not only being the policeman and judge, but also the mayor, fire chief and all of the other civil positions necessary to establish order, help those in need, and return to stability. It found itself alone in this regard initially, although it now performs these duties in cooperation with the UNMIK-Police.

Information sharing for the military versus law enforcement is different. Police operations require training in police tactics and techniques such as crime scene procedures. These differ from military training and capabilities, especially as they relate to fighting a war. The military does have its own internal criminal investigation facilities and these were used to satisfy immediate MNB needs and to bridge gaps until an UNMIK-Police organization could be put into place.

In Bosnia, the political decision-making process was slow and NATO and national guidance was kept closely held. As a result, planning was disjointed at the outset, and there was inadequate sharing of intelligence and force-deployment information among the coalition players. In both Bosnia and Kosovo, NATO command structure experienced difficulties operating in a political and civil vacuum. In addition, there had been only limited military precoordination planning with International Organizations and NGO elements. And although there were pre-deployment exercises that dealt with civil-military issues, there was a critical lack of representation from the civil organizations.

Special Information Security Arrangements

Information security and dissemination differ for the NATO/military versus the International Organizations. The NATO Balkans operations (IFOR, SFOR, Allied Force, and KFOR) required the establishment of special information security categories, information release procedures, and information dissemination networks. National-releasable material was

not necessarily NATO releasable, and NATO-releasable information was not automatically IFOR, SFOR, Allied Force, or KFOR releasable.

In Bosnia there were separate data networks to disseminate nationally sensitive and classified information, e.g., SIPRNET for the U.S. elements. In addition, NATO established a NATO Secret WAN for use by allied member nations; LOCE was used for IFOR/SFOR-releasable intelligence dissemination, and the IFOR/SFOR Secret WAN (CRONOS) was for Ops-Intel to headquarters and multination division headquarters. Non-NATO member nations of the coalition were not allowed direct access to these networks. NATO established a separate data network for disseminating sensitive information to non-NATO troop-committing nations.

During the air war, both NATO and national networks supported C2 needs. SACEUR/CINCEUR and his commanders for Air Operations C2 used NATO and U.S. VTC networks extensively. NATO and U.S. data networks supported general officer e-mail traffic, and became the de facto formal messaging system.

There were separate message systems for tasking the air operations: the NATO Air Tasking Message (ATM) and the U.S. Air Tasking Order (ATO), the latter being used to task U.S. stealth operations during the initial phases of the operation. Interestingly, for the non-stealth operations, the NATO LOCE was used to disseminate the ATM/ATO to U.S. air elements at co-located operating bases.

In Kosovo, once again there were separate national networks: a NATO Secret WAN, a KFOR Secret WAN, and a KFOR Unclassified WAN (Internet). LOCE supported KFOR as well. *Operation Allied Force* used CRONOS and LOCE for Ops-Intel and also to disseminate the NATO-common operational picture as well as the NATO air-tasking message (in U.S. parlance, the air tasking order).

The issues for the International Organizations and the U.N. diverged from the NATO/military problems of multifarious and redundant systems. The IOs, which operate on the basis of transparency, impartiality, and the rule of law, now are learning that with expanded responsibilities in peace operations, such as election monitoring, arms control verification, and law enforcement, there is a new need for active intelligence collection. The U.N. is finding itself in vulnerable positions where conflicting parties are taking advantage of its naiveté, knowledge gaps and other weaknesses with increasing frequency. This creates a complex

dilemma for it; that is, in trying to live up to high ethical standards while attempting to determine the degree of secrecy to employ in a peace operation. It is also a particularly difficult problem for the U.N. since it, unlike nations and their militaries or NATO, for which tried and proven procedures exist, is just at the inception of formulating its policies and procedures for such operations.

As a result of early experiences in Bosnia, where U.N. in-the-clear messages were being intercepted and exploited by the Serbs, the U.N. now has a limited, secure communications capability deployed in Kosovo. In addition to selectively employing secure communications and information systems, the U.N. also needs to establish capabilities, processes, and procedures to deal with collection, classification/declassification, storage, and dissemination of sensitive information in a systematic fashion. Compatibility with NATO and national capabilities to facilitate sharing of sensitive information and secure interoperability are yet to be determined.

Information Sharing Not a Natural Proclivity

Information sharing is not a natural proclivity for many of the organizations and actors involved in coalition operations. Military and intelligence organizations are not accustomed to sharing data with international and NGO organizations, and vice versa. For operational security reasons, there is a continuing reluctance on the part of the military to share time-sensitive operational information with anyone other than military—especially multinational political bodies. Even for military-to-military sharing, strict need-to-know rules are applied. Fears that data will be misused or that databases contain inaccuracies also work against open information sharing.

Even in military-to-military sharing, not all nations in a military coalition are treated as equals. Many partners in today's operations are former enemies in the cold war, so there are different levels of need-to-know restrictions placed on sharing sensitive military-related information with them. On the other hand, there is a need for the Western nations to learn how to make better use of the military intelligence and political and cultural insights that these former enemies bring to the table in support of coalition peace operations, especially in areas where they may have more experience and understanding of the environment, the Balkans being a prime example.

NGOs and the media are concerned about maintaining the perception of their neutrality and are afraid of being perceived as pawns of military intelligence organizations. Therefore they are hesitant to work too closely with the military. In addition, they do not always share the same objectives, and are suspicious of national government intentions. NGOs need certain information or assistance from the military, such as weather, threats, military movements, and hostage rescue or evacuation parameters, if needed. For example, they need to know about the availability of military transportation services in order to carry out their humanitarian support activities. On the other side, the NGOs in particular, have insights useful to the military regarding as how to accomplish things in the locale, brokering cooperation from key locals, and identifying potential problem and humanitarian assistance areas.

There is a need in peace support operations to increase trust and improve the ability to share the information necessary to achieve both the civil and military goals. This must be done without undermining the International Organizations' and NGOs' neutrality and the military's sensitivities to exposing operational security information. This is a fine line to walk; but it can be done if everyone is sensitive to one other's concerns. In Kosovo, UNMIK, KFOR, and the NGOs seemed to have a reasonably good working relationship. They met frequently to coordinate and inform each other on activities of mutual interest. Information centers were established throughout Kosovo. They were used by UNMIK, OSCE, KFOR and its MNBs to provide a means for improving collaboration, coordination, and information sharing among the various actors, including the international and local NGOs and all local ethnic groups.

The Media: Friend or Foe?

The media's job is to tell the story as they see it. The media, however, are an assemblage of competing organizations, each with its own agenda. The media are neither partners nor opponents of policy-makers and military commanders; yet what they cover and how they cover it affects both. Frequently journalist and reporters find themselves in harm's way while trying to get the story. Some, in the end, make the ultimate sacrifice.

There appears to be a growing concern that today's media may be focusing too much on getting the sensational stories that sell magazines, newspapers, and airtime on radio and TV, rather than on reporting a

balanced mix that includes other equally important, but perhaps less visual and dramatic stories. The media are everywhere and report live events around the world—in some cases even before the commanders on the ground are aware of them. The military is sensitive to the CNN effect of instant, worldwide reporting and its potentially adverse impact on ongoing operations. It is also wary of unsubstantiated reports to which it must react to in order to clarify situations to higher authorities. The latter had to be done many times in Bosnia and Kosovo, and required diverting scarce military resources urgently needed elsewhere.

The media on the other hand, are very leery of the military's attempts to overtly control their activities, and also react negatively to the government and military's use of spin doctors. IFOR, SFOR, and KFOR had quite good working relationships with the press, mainly because public affairs had the commander's personal attention and the media had direct contact with the military. During the air war over Serbia, press relationships were somewhat strained during the initial phases of the operation. This was due to military restrictions on the release of operational information and the inability of NATO spokespersons to counter media skepticism about the exercise. But the relationship improved midcourse with the establishment of a NATO media operations center. It linked NATO with SHAPE and key national capitals, and improved the quality and timeliness of information released to the media.

The military and International Organization public affairs officers are just as defensive as the media are to losing impartiality and legitimacy. They are the honest broker spokespersons for their organizations and leaders. A lesson repeatedly learned by the military is that media coverage matters and that the role of military public affairs should not be underestimated. The delicate balance between operational security and providing open information continues to drive the military to be much more cautious and selective in sharing information with NGOs, media, and other nonmilitary organizations.

The Balkans have been a good learning experience, and progress is being made to improve military information sharing with the media, NGOs and others such as multinational political bodies like the U.N. and NATO. For example, the media operations center set up at NATO headquarters during the air operation facilitated national coordination and improved the NATO public information office's access to military information. Moreover, the U.N., UNHCR, OSCE, E.U., KFOR, and the

lead-nation military elements of the Multinational Brigades established public information centers throughout Kosovo for NGOs, the public, and other interested parties.

Although every effort was made to place the public information centers outside the wire of military installations in order to facilitate international and local press access to the military, this was not always done. For example, unlike KFOR and the other MNBs, the German and United States' press centers were located inside the wire of the base camps, limiting freedom of access. Putting public information centers outside the wire did require some military security measures to ensure the safety of journalists should an attack occur. The KFOR Coalition Press Information Center (CPIC) was located in downtown Pristina, next to the sports stadium. Each of the MNBs had public affairs LNOs at the CPIC. The CPIC was used for press briefings and as an information center where not only KFOR and MNB related information was available, but also UNMIK, UNHCR, OSCE, World Health Organization, and others'.

Some Other Hurdles

There are cultural and language differences that affect collaboration, coordination, and information sharing. Players on the peace operation battlefield come with differing expectations, skills, capabilities, and experience, and not all speak the language of the coalition operation or the country in which they are operating.

Plan-We-Must Versus Plan-If-We-Can

The military approach is plan-we-must and is highly structured, disciplined and focused. It places a wide footprint on the ground in terms of an overwhelming capability, for which it attempts to define a clear end state, with the ultimate objective to get out as soon as possible. Conversely, for the International Organizations and NGOs it is more like plan-if-we-can. They lack the structure and discipline of the military, plus they have a much broader focus. Their footprint on the ground is much more limited, as are their capabilities, and their end state is less well-defined, with many of them remaining in the country long after the military leave.

Language Remains a Challenge



Figure 6. Local Hire Albanian Interpreter

Language continues to be a major problem for the military. These operations tend to occur in areas where the military language training programs do not provide an adequate supply of qualified linguists. In Kosovo, the interpreters were a mix of U.S. military and civilians and locally hired Albanians and Serbs. There was something on the order of 400 contract interpreters in MNB(E) alone. Many of the U.S. citizens had clearances, and were used for sensitive military assignments, such as being attached to Special Forces teams. Most interpreters were fluent in one language and had a working knowledge of the other. One therefore had to be careful about using Albanian interpreters in Serb areas, and visa versa, since locals could quickly tell the difference. Many times the military had no choice and had to emphasize that they were there to help everyone regardless of ethnicity. This was particular difficult in Serb areas where the use of an Albanian interpreter would provoke anger.

Many of the male interpreters were easy to identify. They were the long-haired guys in fatigues standing in the mess hall line. Others such as the one shown in Figure 6 (the person next to the soldier with the helmet on) looked like any other soldier. This particular individual was a local Albanian from Gnjilane who worked with the U.S. tactical PSYOP teams. He said he learned his English from watching U.S. TV and movies and from the G.I.s.

Locally employed interpreters sometimes explained rather than translated, or added their own spin, and required careful monitoring. In Kosovo, a number of soldiers who could not speak Albanian or Serbian found it more useful to try to speak to locals in German or Italian rather than use interpreters. This practice established direct communication and had a positive effect.

Most of the interpreters were hired locally via an Army contract with TRW. There were also many local employees through Brown and Root (probably the largest employer in Kosovo) who were engaged to support Camp Bondsteel and Camp Monteith day-to-day operations, e.g., laborers, dining facility, PX, and laundry and cleaning services. The use of locals has a downside security risk that needs to be watched closely and managed daily.

Interpersonal Skills and Training Make a Difference

Information sharing among organizations also has personality, education, training, and experience aspects that influence the degree of cooperation, coordination, and sharing that may be achievable in a multinational operational environment. Picking key leaders that promote and demonstrate open communication and cooperation has a primary constructive effect on how well the rest of the organizations function together. The value of collaboration needs to be an integral part of the education and training of the participants.

The use of joint planning and training before deployment also has a crucial effect on successfully implementing civil-military cooperation and information sharing when intervention takes place. NATO and U.S. forces are employing pre-deployment exercises to prepare replacement forces and the U.S. military uses what is called right-seat training to facilitate the transfer of responsibilities on the ground. In Kosovo, at the UNMIK Special Representative of the Secretary General and COMKFOR level, there was excellent cooperation, and this flowed downward in their respective organizations. The SRSG and COMKFOR met daily, and KFOR provided assistance to UNMIK to help it develop an UNMIK Strategic Planning Document.

Ad Hoc Arrangements Pave the Way

The success of peace operations continues to rely heavily on the professionalism, dedication, and ingenuity of the individual men and women who were there. Agility and accommodation remain key as the civil-military community persist in trying to understand how modern information technology can be used to synchronize activities in support of peace operations and to facilitate more open information sharing. Many times, ad hoc arrangements helped to resolve the collaboration, coordination, and information-sharing challenges in the environment.

Whatever Works

A cottage industry of liaisons emerged in Bosnia, and in Kosovo to a lesser extent. There were liaisons between IFOR/SFOR and the Multinational Divisions (MND), among the MND headquarters, between the MND lead nations and non-NATO military units assigned to them, between IFOR/SFOR/MNDs and International Organizations such as the OHR, U.N. and OSCE, and between these organizations and NATO, the NGOs, and the Bosnian civil agencies, such as the water, power and telecommunications utilities.

In Kosovo, liaison exchanges were most prominent between the KFOR and its MNBs, and between MNB lead nations and the military elements assigned to them. KFOR headquarters were responsible for coordination and synchronization of MNB activities; but a plan and process for doing this was lacking. KFOR efforts were focused more on collaboration and cooperation with UNMIK. KFOR provided liaisons to UNMIK and UNMIK provided liaisons to the MNB headquarters. There were no liaisons exchanged between the five MNB headquarters, and this served to make cross-MNB leveraging that much more difficult. The MNB civil affairs units played a major role in interfacing with nonmilitary organizations such as UNMIK, OSCE, the NGOs, and local organizations. Military liaisons were instituted by some of the larger NGOs to help improve their overall relations.

In the U.S. sector, MNB(E), U.S. Civil Affairs teams were co-located with the UNMIK regional office in Gnjilane and municipal offices in major cities such as Vitina, Kamenica, Strpce, and Kacanik. The U.S. MPs were co-located with UNMIK-Police at U.N.-established municipal

police headquarters. U.S. Intelligence and Special Forces liaison teams provided specialized support to the non-U.S. elements assigned to MNB(E). Italian Carabinieri of the Multinational Specialized Units that reported to COMKFOR also had units assigned to each of the MNBs. There were also liaisons at other command and organization levels, such as at SHAPE headquarters and the Partnership for Peace nations, and there were Russian liaison elements. The NATO Combined Air Operations Center employed resident, national military air liaisons to support air operations' cooperation, coordination, and information sharing. There were NATO civil aviation liaisons with EUROCONTROL and the national Civil Air Traffic Control organizations during the air war, and the NATO Media Operations Center had national, civilian and military liaisons and NATO-military representatives. These are just a few examples of some of the liaisons that were utilized to bridge language, culture, doctrinal, procedural, and communications gaps and to facilitate coordination, cooperation, and information sharing in a multinational operational environment.

Strong leadership and collaboration skills are critical to achieving more open information sharing. Lack of trust is a fundamental source of tension in coalition operations. Trust relationships are earned and can be easily broken. Therefore, selecting senior leaders who can build and sustain trust relationships and work together for the common cause is an important consideration in building the team. In reality, however, these do not seem to be the major factors when selecting leaders for peace operations. More often than not, it seems to be the luck of the draw for the coalition peace operation team.

At the outset of the Bosnia operation, the senior-level civil-military relationships were not as strong as those established in Kosovo, where the Senior Representative of the U.N. Secretary General and Commander KFOR work very closely together and met daily. Their staffs also worked together very closely, enabled by the co-location of some KFOR CIMIC staff at UNMIK headquarters in Pristina. As noted earlier, UNMIK liaisons were placed at MNB headquarters to facilitate the exchange of information. The early COMKFOR leadership established frequent and close direct ties with the MNB commanders, with whom they met weekly; but with the transition of KFOR leadership to EUROCORPS, direct ties seemed to occur less frequently, and were more often at the deputy COMKFOR levels. The COMKFOR focus during the EUROCORPS

regime seemed to be more politically oriented, and aimed at UNMIK, OSCE and other political bodies.

There were formal and many ad hoc joint working groups, joint commissions, and other joint activities formed to facilitate collaboration, coordination, and information sharing in the Balkans. In Bosnia there was the Joint Civil Commission and the Joint Military Commission that were used to synchronize civil and military activities respectively, and to deal with faction military leadership and their adherence to the terms of the Military Annex to the Dayton Agreement. In Kosovo, there was the Joint Interim Administrative Structure and the Joint Implementation Commission. The former dealt with civil administration and the latter ensured compliance with the provisions of the Military Technical Agreement. The JIC was also used to oversee activities of the Kosovo Protection Corps, which was composed of leaders and members of the demilitarized UCK/KLA. There was an MNB(E)-chaired Joint Security Committee (JSC) that dealt with regional and municipal security matters. The MNB(E) JSC met weekly at the UNMIK municipal offices. These meetings provided an opportunity for the military, UNMIK, and NGO representatives to discuss activities and issues and to assign actions for resolution. In MNB(E) sector, there was also a weekly UNMIK four-pillar meeting held at the UNMIK regional office in Gnjilane, for which Task Force Falcon represented KFOR.

The U.N., OSCE, and KFOR and its MNBs set up information centers that were located in the major cities and provided free and open access to all who wanted to use the facilities. In Pristina, there was the Humanitarian Community Information Center that was supported by U.N. elements, as well as other organizations, and it encouraged and enabled the exchange of information among the wide range of actors working in Kosovo. KFOR CIMIC used the HCIC facilities as its de facto CIMIC Center. The OSCE established information centers in major cities to facilitate coordination with local NGOs. The MNBs established information centers either co-located in municipal UNMIK facilities or in facilities they took over for this purpose. In the case of the latter, these centers were located as storefront operations within the cities, usually near Serb enclaves.

KFOR Public Affairs created a Joint Information Bureau and employed a Joint Information Coordinating Committee to focus efforts and coordinate, collaborate, and share information among public affairs

units and the media. There were joint coordination working groups established by Civil Affairs (in NATO terms, Civil Military Cooperation, or CIMIC), PSYOP, and information operations to foster collaboration, coordination, and sharing of information between these multinational parties. The activities of the committees and working groups were not directive in nature, but were consensus building. The purpose was to establish a shared awareness of ongoing efforts and concerns of KFOR and the MNBs. The working groups also served to help resolve conflicts and to boost overall efforts. In most cases, NGOs were invited to participate, but rarely did, except for the CA/CIMIC working groups.

There were a number of UNMIK and HCIC initiatives to create a voluntary information group composed of consumers and providers of information, to broaden the HCIC information databases and information-sharing role, to select a GIS software standard (e.g., MapInfo was used by a number of organizations), and to install an UNMIK Chief Information Officer.

Many other ad hoc activities ebbed and flowed as dictated by operations on the ground.

Intelligence is Always a Challenge

The intelligence community employed National Intelligence Cells (NIC) to facilitate collaboration and coordination at headquarters levels, and lead nations used intelligence support teams to facilitate exchange of information with non-lead nation military units assigned to their area of responsibility. For example, in MNB(E) the U.S. intelligence support team with the Russian brigade not only translated releasable KFOR intelligence into Russian, but also translated news stories from the Internet that related to Chechnya and provided these to them as well. The Russians did not have good access to news and the units in Kosovo were from the Chechnya operation. Many would be returning to this operation at the completion of their Kosovo tour.

The NATO Combined Air Operations Center created an Intelligence, Surveillance, and Reconnaissance Cell to coordinate collection management in support of IFOR, SFOR, KFOR, and *Operation Allied Force* requirements. During the air war, a U.S. intelligence cell was established at SACEUR's Chateau in order to be able to provide General Clark with continuous current intelligence even when he was at home.

There was also an operations officer available at the chateau to provide him with operational information as events unfolded.

For Bosnia, there was an Intelligence Coordination Cell (ICC) established and staffed by multinational representatives at the U.S. Joint Analysis Center (JAC) in Molesworth, England. The ICC supported field requests for information, the integration of multinational intelligence inputs and the dissemination of processed intelligence to IFOR/SFOR elements using the LOCE network. The ICC supported KFOR as well. It was a de facto intelligence help desk, where nationals in the field, whose English speaking skills were limited, could ask national counterparts at the ICC for information in their native language.

The Balkans is a HUMINT-intensive environment, and as was the case for IFOR/SFOR, a J2X was used by KFOR and a G2X by MNB(E) to coordinate and resolve conflicts in multiple HUMINT activities. MND(N) in Bosnia used the concept of a HUMINT coordinator, a G2X, with great success. In Kosovo, the role of the G2X was more of a challenge for MNB(E) and not quite as successful as experienced in Bosnia by MND(N).

Interpreting requests for information at high-level centers such as the ICC and national rear area intelligence and information centers, may not only have a literal component (what was said, what was meant, and what was understood may not be the same thing) but can also have an understanding, or appreciation, component, since perspectives differ as one moves up the command levels and gets further away from the actions on the ground. The U.S. employed National Intelligence Support Teams at its NICs as a way to bridge communications between the rear area capabilities with the commander on the ground. Intelligence analysts were also frequently sent into the field with the troops in order to address potential gaps as well. These approaches served to improve the overall understanding and responsiveness of the intelligence community to the on-the-ground commander needs.

Open source information publications such as Pentagon *Early Bird* equivalents were produced daily in the U.S. sectors. In Bosnia it was the *Night Owl*, and in Kosovo, the *Daily Falcon*. The OSCE monitored the local media activities in Kosovo, reported daily on the content of the Serb and Albanian radio and TV network broadcasts and print media articles, and reported violations of U.N. media policy directives.

The OSCE also produced a weekly summary report, and all reports were available in hard copy or electronically over the Internet.

Interoperability and Information Sharing: It's Not a Technology Issue

As was the case in Bosnia, communications and information-system interoperability and sharing of information among NATO, national militaries, International Organizations such as the U.N., and the NGOs was problematic in Kosovo too. In fact, there were fewer interconnections of networks in Kosovo than there were in Bosnia. When information sharing did take place, sneaker nets tended to be the mode of choice. Multiple stovepiped systems and duplication of effort proliferated in the Kosovo battlefield. The root cause of this situation was not technical, but largely a matter of political will. The issues were coupled with some continuing distrust between military and nonmilitary organizations and outdated, restrictive NATO and national policies regarding the sharing of so-called military information. The unwillingness to provide some limited-guard gateway interconnection for the respective data networks exacerbated the situation. Interoperability of NATO STU-IIB and U.S. STU-III A continued to be a problem in Kosovo in spite of the fact that this has been a well-publicized issue in the Balkans and elsewhere. The U.S. solution would be quite simple: deploy with the NATO-compatible key.



Figure 7. PTK Building in Pristina

Another complicating factor was that although many lessons were learned in Bosnia, Kosovo was not Bosnia. The Kosovo public telecommunications services (PTK) were inadequate before the air war, and Operation Allied Force solved this problem by neutralizing any functioning capabilities that may have existed. This becomes visibly obvious in places like downtown Pristina, where one can see the effects of a Cruise Missile attack that destroyed the telecommunications center (see Figure 7) across the street from the facilities now being used for UNMIK headquarters. The U.N., KFOR, and military voice networks were not interconnected to the degree they were in Bosnia. In many cases, it became necessary, and even easier, simply to meet face to face.

Use of Commercial Products on the Rise

A wide variety of commercial products and services now offer military-grade features, including rapid, globally deployable, self-sustaining communication capabilities and voice and data network encryption. NATO and its allied militaries are moving towards more extensive use

of a mix of commercial and military systems, and the commercial sector is becoming a dominate player in providing communications and information systems support for peace operations. Adding momentum to this trend is the fact that the number of simultaneous peace support operations being conducted around the world by the military is accelerating. Coupled with today's military insatiable appetite for information, the bandwidth needs far exceed that which current military tactical systems can effectively support for globally deployed forces. Hence, commercial products and services have become a necessary and viable alternative to meet real world operational needs.

The commercial sector supports deployable military C2 packages such as the U.S. Army Fly Away, the U.S. Marine Corps JTF Enabler, and the U.S. Air Force Communications Reception Teams. The emerging strategy for sustained operations is to replace military tactical capabilities as soon as possible with commercial capabilities such as the U.S. Army Dragon package and the U.S. Air Force Theater Deployable Communications-Integrated Communications Access Package. The intelligence community also uses commercial capabilities extensively to support forward-deployed elements and to provide access to rear area intelligence centers and analysis teams.

Enhanced military-like services derived from commercial products and services such as VTC, data networking, and e-mail have both innovative results—and unintended consequences. During the air war, virtual C2 of the air operation became the way of doing business. VTC was used to link geographically dispersed commanders, and the data networks facilitated near real-time sharing of information among commanders and staff. VTC and the data networks allowed the commanders and staff to rapidly reach anywhere in the world for whatever expertise was required. IFOR, SFOR, and Allied Force commanders used VTC extensively for command control; but in the case of KFOR, it was used less frequently, and seemed to be used more for informing and coordinating than for command and control.

E-mail became the formal messaging system. This raised questions regarding what e-mails were directive in nature and which ones were simply action officers sharing information, ideas, or opinions. Signature authority control, audit, and assured delivery requirements for formal military messaging were violated as well. Although there were videotapes of VTCs, there were no written transcripts that could be

used to inform others, and there was no complete written record of operational decisions for historical purposes. As a result, the military commanders feel strongly that a key lesson of the Balkans is the imperative to clarify the role of e-mail in combat operations and to instill discipline in the use of both e-mail and VTC.

Experiences and lessons from ongoing peace support operations should lead to a further break down of the barriers to information sharing, and ultimately to a willingness to consider selective, operationally appropriate interconnection of military and nonmilitary systems to meet peace support operations needs. Using commercial products and services may be a means to achieving this end. For example, in Kosovo the Internet became, in effect, the information sharing network among the civil and military participants. Hotmail and Web sites were used extensively for sharing relevant peace operations' information.

Extending Services into Kosovo

The U.N. extended its commercially based global communication and information system into Kosovo to provide voice and information network services, including e-mail and Internet access, to all of its deployed elements. The UNMIK network is a mixture of leased services and U.N.-provided services. NATO contracted a commercial, turnkey service for its KFOR voice and data network services. There was also a military tactical network overlay to support essential KFOR command and control needs.

The commercial- and military-provided services supported KFOR headquarters and extended connectivity and access to its Multinational Brigade headquarters, KFOR support elements, and NATO and SHAPE headquarter units. Each of the five Multinational Brigades deployed a mix of military-tactical and commercial capabilities.

For the sustained operations phase, the U.S. Army deployed its *Dragon* package, which is a commercially based, contractor-maintained-and-operated capability. The *Dragon* package fulfills the communications and information needs of Camp Bondsteel and Camp Montieith, the major U.S. support bases in Kosovo, and Camp Able Sentry in Macedonia. U.S. military tactical systems were used to support deployed units and essential MNB(E) headquarters command-and-control needs. In MNB(E), the Army Trojan Spirit, special-purpose systems and national intelligence systems, used by the National Intelligence Support

Team, provided its own independent and stovepiped capabilities, which included commercial products and leased services. The U.S. UAVs were used extensively—Hunter more than Predator in Kosovo—and their video was broadcast real time over the Joint Broadcast System to the MNB(E) and KFOR/U.S. NIC intelligence cells. National Intelligence Cells of the United States, United Kingdom, France, Germany, Italy, and other nations provided intelligence services to KFOR J2. The NATO-provided LOCE and CRONOS networks were also used by KFOR for intelligence dissemination.

Commercial SATCOM and Cellular

Leased, commercial SATCOM is the major long haul provider of connectivity for military and nonmilitary systems deployed in Kosovo. Commercial satellite phones such as INMARSAT continue to be used for contingency operations; but commercial cellular phones, European GSM-based system, emerged as the communicating means of choice in Kosovo, especially for the non-U.S. forces.

Internet Comes of Age



Figure 8. Sign for Internet Café in Pristina

The Internet played a major role in informing and facilitating information sharing among the various parties. Internet Web sites were used extensively for open information sharing and informing. E-mail provided an alternative means of communications to public telecommunications and served to facilitate information sharing across traditional military and nonmilitary boundaries.

A nonprofit organization, IPKO, instituted an Internet service provider in Pristina, which supplied access to several of the larger cities and offered Internet services to organizations such as the U.N., OSCE, and a number of the larger NGOs. They also supported “Internet Cafes” for general public use as well (see Figure 8).

There were, however, some difficulties associated with the use of the Internet, such as the “ILOVEYOU” virus that temporarily disabled some NATO and national military data network capabilities in Kosovo. Not only that, the Serbs used the Internet for propaganda purposes. During the air war, they used computer network attack techniques to modify NATO and national Web site home pages and to take down the NATO public affairs Web site. They further used spamming and mail bombs to disrupt Internet e-mail traffic directed to and from NATO headquarters.

Creative Uses of Off-the-Shelf Products

There were new, creative uses of commercial products that emerged in Kosovo. In the U.S. sector, the Motorola *TalkAbout* recreational Two-Way radio was used extensively for dismounted, convoy, and base area communications purposes. It became a real status symbol, and nearly everyone had one clipped to his or her flack vest. There were also other types of commercially available hand-held radios that were used by the NGOs, UNMIK, and KFOR personnel. Use of these unprotected radios introduced military OPSEC risks that needed to be carefully managed.

Another surprise entry was the extensive use of the 3Com *Palm Pilot* for note taking and exchanging information. It was not unusual to see U.S. military staff officer’s scratch notes on their Palm Pilot during a meeting and then use the infrared link to exchange notes or send a tasking. Commercial remote sensing and Geographic Information Systems were used by the military for improved mission planning and by the nonmilitary, such as, the U.S. State Department and the U.N., for Humanitarian Assistance and nation building planning and assessment

activities, such as refugee returns, reconstruction and mine location and clearing actions.

Kosovo—An Information-Poor Environment

Kosovo civilian radio and TV stations were destroyed by the air war. The fact that a large portion of the educated and technically skilled Kosovo work force were Serbs who fled when the bombing started or when KFOR occupied Kosovo further complicated the situation. They still have not returned. The mass exodus of Serbs also resulted in the print media being reduced to Albania-only products. Commercial enterprises, such as Radio Shack or CompUSA equivalents, were, and still are, nonexistent in Kosovo. After a year, commercial radio, TV, and print media are recovering; however, there is yet to be a Serbian language daily newspaper produced in Kosovo for the Serb community. Serbian language papers come from Serbia. Remote villages lack adequate access to media outlets, so little current information gets to them. Some villages have radio; but few have TV or print media access.

The Internet has become a lifeline to the outside world for the civilian population in the major cities such as Pristina. For many people in the new Kosovo, e-mail was the only mail. Although progress has been made over the last year, much still needs to be done for Kosovo communications and information.

Information Operations

Like Bosnia, coalition information operations in Kosovo dealt with truth projection. As a result, all of the peace operation parties got involved. Furthermore, there were multiple information campaigns being conducted simultaneously in spite of KFOR efforts to pull the UNMIK, OSCE, KFOR, MNB and NGO community together in order to integrate their efforts. KFOR did not issue orders but sought collaboration. Meetings with the MNBs were held weekly in an attempt to create a shared understanding and agreement on the information campaigns to be conducted by the MNBs, and so that they at least generally met the COMKFOR priorities and intent. Other organizations such as UNMIK and the NGOs were invited but rarely came.

“Weapons of Choice”

The KFOR information operations “weapons of choice” were public information, PSYOP, Civil-Military Cooperation, and the Joint Implementation Commission. Use of disinformation and deception were not allowed. Only “white” PSYOP was employed, and there was no KFOR-led counterpropaganda campaign in spite of extensive use of propaganda by the Serbs. The general rule of thumb was “do not react to disinformation. Instead, react to selective issues of importance and tell the truth.” The goal was to create conditions for the implementation of a political settlement. This resulted in themes such as: promote a safe and secure environment, deter violence and criminal activities, encourage a free and open society, promote a positive UNMIK and KFOR image, and mine and UXO awareness, to name a few. The target population was mainly 20 to 50 year olds and was a mix of Roma, Turkish, Albanian, and Serbs. Teenagers were not a major factor in the KFOR information campaign. In Bosnia, the German PSYOP product “MIRKO” was specifically targeted for teenagers, and was one of the more useful products produced by the IFOR/SFOR information campaign. A similar product was not funded for Kosovo and little effort was directed at addressing teenagers’ needs.

The KFOR information operations cell activities focused on planning, coordinating, collecting data, analyzing the effectiveness of the information campaign, assessing all activities of KFOR from an information operations perspective, and advising COMKFOR accordingly when conflicts arose.

MNB information operations cells such as the MNB(E) Task Force Falcon Cell employed a similar focus for their area of responsibility. The MNB(E) activity was more intense than the KFOR and other MNB efforts. Additionally, it was a structured process with direct commander interest and involvement and brought all players of the Task Force Falcon team (the Commander, PA, CA, PSYOP, J2, J3, MPs, Maneuver, and others) into the planning and execution process. The U.S. Land Information Warfare Activity was used by the MNB(E) commander to lead and orchestrate its information campaign. KFOR sponsored separate weekly information operations and PSYOP working groups as a way to facilitate collaboration and coordination, to encourage building common themes and objectives, to share insights on activities being pursued by the various players, and to resolve conflicts where necessary and possible.

Approaches and Products

UNMIK, OSCE, KFOR and MNB approaches and products included the use of newspapers, including inserts for local papers, magazines, posters, handbills, radio/TV, press conferences and releases, and Internet Web sites. UNMIK published the *UNMIK News*, OSCE, the *UPDATE*, UNHCR, the *Humanitarian News*, KFOR, the *KFOR Chronicle*, and, at the MNB level, the U.S., the *K-Forum* and *Falcon Flier*, for example. Paid inserts for local newspapers (mainly, Albanian since there was no Serb press in country) were employed by KFOR and MNB(E). The U.S. Task Force Falcon PSYOP team had the responsibility for the MNB(E) products. KFOR produced a monthly magazine called the *Dialogue*.

For focused activities such as land mine and UXO awareness and stop-the-violence and safe-and-secure-environment messages, KFOR and the MNB PSYOP teams used posters and handbills extensively. KFOR and MNB(E) both funded radio stations and KFOR TV programming as well. Airtime was purchased by KFOR for RTK TV broadcasts in Pristina. Popular music and KFOR message scripts were provided to radio stations for broadcasting, and weekly commander talk shows were employed to get the KFOR message on the airwaves and to discuss local issues and initiatives. Where telephone service existed, people could call in to talk to the commander while on the air.

In MNB(E), the Medical Civil Action Program (MEDCAP) also played an important role in support of the information campaign in addition to its primary role of providing medical services. Several times a week MEDCAP units would visit different remote communities to provide immediate medical care to persons suffering from minor conditions. The MASH-style hospital tent complex on Camp Bondsteel in MNB(E) provided emergency medical services for not only the military, but local nationals as well. The Germans in MNB(S) also employed MEDCAP-equivalent activities, and they too had a field hospital that provided emergency medical services for local nationals. The outstanding services provided by these activities served to re-enforce KFOR legitimacy and to promote a very positive image of the United States, German, and other KFOR forces in Kosovo.

Finally, the information operations team created talking points that addressed key KFOR and sector issues and objectives for the

information campaign in MNB(E). Typical subjects addressed a wide range of interests, like refugee returns, civil registration, mine awareness, transfer of authority for the 1 ID to 1 AD transfer, rule of law, and stopping the violence, the role of the Kosovo Protection Corps, the role of the Kosovo Police Service, and the status of UNSCR 1244. These talking points were updated weekly or as required, and distributed to all levels of command. They served to provide a common perspective and to educate those involved in the operation. Thus while they were on patrol or engaged in discussions with the local populace and community leaders, the soldiers could be prepared to discuss issues and initiatives in some detail. Commanders on the ground viewed this as a very effective tool in the conduct of their campaigns.

Unlike Bosnia, where the newspaper *Herald of Peace* was printed in two languages, this was not possible in Kosovo because of the strong ethnic differences. Separate papers had to be published. The only source of Serb language newspapers locally was Serbian papers out of Belgrade, and in fact, OSCE helped to have them distributed in Kosovo. The Serbian newspapers contained propaganda as well as news.

Other Challenges

There were numerous other challenges. The Serbian Red Cross were funded and controlled by the Serbs. It was reported that they were taking USAID and other international aid packages and covering the source markings with Serbian Red Cross markings before distributing to the Kosovo Serb community. Interpreters/translators needed to be kept track of to ensure the radio/TV transcripts and newspaper inserts initially written in English were translated properly into Serbian and Albanian and that the right words used before being broadcast and distributed. Broadcasts were monitored to make sure that correct messages were actually aired on the radio and TV. It was also important that printed material targeted for Serbs in fact went to the Serb communities, and likewise for Albanian material. Frequently those distributing print material had to make a special effort to determine the homes that were Serb and the homes that were Albanian in mixed communities before delivering the material. KFOR and the MNBs needed a professionally trained and experienced radio and TV team in order to compete effectively with the Serbian media activities, which

employed professional journalists, newscasters, scriptwriters, and R/TV producers and broadcasters.

Product Testing

Information campaign product testing and assessments of effectiveness used multiple, but simple, approaches. Local hires were used, as was random street testing, before issuing a publication or product. A Gallop Poll was sponsored by KFOR and conducted Kosovo-wide every three months. Radio shows were taped and reviewed as part of the quality monitoring. OSCE performed daily media monitoring and provided daily and weekly summary reports of radio, TV, and print media activities. KFOR and its MMBs also used open-source monitoring, including Internet Web sites, to assess information campaign effectiveness.

Complexities of the Air War

Information operations during the air war was much more complex. Propaganda, computer network attack, deception, poor NATO and coalition OPSEC posture, and other factors were exploited quite effectively by the Serbs to manipulate NATO's battle space awareness and its ability to conduct an effective information operations campaign. Since NATO did not engage in counterpropaganda, only truth projection, there were only national-led efforts to counter Milosevic's activities. For example, during the air war, the U.S. Information Agency's (USIA) Information Bureau, now operating as the U.S. State Department's Office of International Information Programs, tailored a number of information campaign and counter-propaganda activities that exploited the Internet. Their Kosovo Web site distributed video, print, and audio information in eight languages. A public outreach list-server provided information to foreign and national opinion leaders. In a public-private partnership, Internet centers were established at refugee centers in Europe and the United States that allowed refugees to access information and send e-mails to trace family members. An online newspaper was distributed to all locations hosting refugees to inform them of items of interest to their welfare and tracking family members. The Information Agency's cyber-watch group remained active throughout the conflict in order to track Kosovo coverage on the Internet and monitor Serbian disinformation. These initiatives can serve as models for future information campaigns.

U.S. Congressional testimony suggested that both NATO planners and users of information were not adequately prepared to conduct information operations. The pool of personnel available to perform certain key functions such as language translation, targeting, and intelligence analysis was limited, and the conduct of an integrated information campaign was delayed by the lack of both advanced planning and strategic guidance to define key objectives. Additionally, getting the attention of the senior, fighting commanders to convince them that information operations were a force multiplier was a challenge as well. In the view of Admiral Ellis, USN and Commander Joint Task Force Noble Anvil, “At once a great success...and perhaps the greatest failure of the war. A properly executed information operations could have halved the length of the campaign.” Progress is being made; but there is still a lot to be learned about conducting a coalition information-operations campaign.

The Way Ahead

Civil-military unity of effort has been an essential, yet frustratingly elusive, requirement for success in post-cold-war peace operations. At the outset of the Kosovo operation, the political end state was ill defined and there was no political-military strategic plan. The planning among the participants was fragmented. The KFOR command arrangements were politically driven and the C2 relationships lacked specificity and were complex. Contributing to the confusion were the inadequate definitions of the cold war derived NATO C2 states of command—OPCOM, OPCON, TACOM, and TACON. They were vague leaving the nations to interpret them as they wished. The civil-military arrangements and processes were complex as well. The UNMIK implementation lagged KFOR and this put pressure on the military to temporarily fill the gap until the civil agencies were capable of assuming their responsibilities. Expectations of the multitude of participants needed to be carefully managed—there were competing interests and fears of loss of power and prestige. There continued to be a general lack of trust among the players and a lack of a shared understanding of the value-added through more open and improved information sharing. Needless to say, the ability to coordinate, collaborate, and share information between civilian and military entities was problematic. Information sharing among the actors on the peace operations

landscape continued to be largely a manual process. Improved information sharing would certainly be a means to an end and could serve to enhance operational efficiencies and thereby avoid wasteful duplication of effort, conflicting advice, contradictory programs, and competing actions. The obstacles to more open sharing need to be recognized and, to the extent possible, practical recommendations developed for ameliorating them.

Two types of information emerged as essential for peace operations. They were the need for current information about the situation on the ground and accurate maps. Military sharing of situation awareness and other information with civil agencies continued to be problematic. In Kosovo, attempts were made to improve shared situation awareness through the use of civil- and military-provided information centers. An excellent example of such a center was the Humanitarian Community Information Center in Pristina, which was run by civilians and was available for anyone's use, be they NGO, local nationals, regardless of ethnic origin; the military, or international organizations. Availability of accurate maps continued to frustrate the military on the ground. Although the U.S. National Imagery and Mapping Agency had taken significant steps forward to improve map quality and make them electronically available to the U.S. military, the process was not good enough at the outset of the Kosovo operation. Tourist maps once again became the map of choice for navigating the streets of the major city areas and neither the military nor tourist maps were sufficient enough for navigating along the poorly defined and marked border areas. GPS receivers were a constant companion of the maneuver and other forces moving around the area. Map quality improved but sharing NIMA maps among coalition partners and for use by nonmilitary elements such as the UNMIK-Police proved to be the next challenge. There is an urgent need for an internationally agreed strategy on sharing in order to ensure nations and international organizations provide the ways and means necessary to accommodate the sharing of appropriate situation awareness and other operations relevant information among the civil-military participants.

Agreed communications and information systems architectures did not exist to guide the planning and implementation of the civil-military systems used in Kosovo. Furthermore, there was no single civil or military organization responsible for system implementation and management. As a result, multiple, independent (referred to as stove-

piped) systems were implemented creating interoperability challenges and security disconnects. The independent civil-military networks were loosely interconnected and did not form a federated network for shared use so there was only a marginal operational ability for the participants to communicate and share information among the communities of interest. In many cases, it was easier to visit the person than to call them. Military and civil organizations both relied to a large extent on the use commercial products and services—these ranged from turnkey communications and information systems managed by contractors to mixed tactical military and deployable commercial capabilities. Satellite phones, cellular and the Internet were major players as well. The mountainous terrain of Kosovo proved to be a performance challenge for the tactical line of sight military communications and this led to workarounds that included creative use of commercial handheld radios such as the Motorola *TalkAbout* sports radios for dismounted operations, convoy communications and base communications. The use of commercial communications and information systems products and services to satisfy operational military C2 needs is feasible, on the rise and cost-effective but there are OPSEC risks that need to be planned for and managed when using these products and services, especially when used without appropriate security protection. The need exists for agreed coalition communications and information systems architectures to guide the planning and implementation of the systems and the interoperability arrangements necessary to facilitate civil-military information sharing. There is also a need for an information management and security plan that details the information sharing and protection requirements for such operations.

Today's information and communications technologies can serve to facilitate exchange among the disparate players of peace operations. The integration of social, economic, political, geographic, weather, military activities, threats, refugee return, reconstruction, human rights violations, criminal activities, and other relevant information and the timely dissemination of the processed information to interested parties in the field, are well within the realities of today's technology. However, uncontrolled use of information technology can result in information overload, blur operational initiatives, and lengthen decision times for military operations in particular. In the end, it comes down to the human element, the ability to find, interpret, and use information effectively, and the willingness to trust each other, openly share information, and to

coordinate, cooperate, and work together for the good of a common cause. As noted at the outset of this chapter, this is not a technology issue, it is an organization and political will issue. Technology is an enabler.

Although agility and accommodation continued to be keys to military success as well as some plain old good luck, in the final analysis it was good people that made it happen. The success of KFOR, and MNB(E) in particular, was because of the professionalism, dedication, and ingenuity of the men and women who were there and those who supported them.

References

- Bonn, K., and Baker, A., 2000. *Guide to Military Operations Other Than War*. Stackpole Books.
- Dorn, W. and Charters, D., 1999. *Intelligence in Peacekeeping*. The Canadian Peacekeeping Press.
- Eisenhour, J. and Marks, E., 1999. *Herding Cats: Overcoming Obstacles in Civil-Military Operations*. Washington DC: Joint Forces Quarterly.
- Olsen, H. and Davis, J., 1999. *Training U.S. Army Officers for Peace Operations*. Washington DC: United States Institute of Peace.
- Siegel, P., 2000. *Did NATO Win the Media War and Does this matter for C2 Research?* Monterey, CA: CCRP Symposium.
- Seiple, C., 1996. *The U.S. Military/NGO Relationship in Humanitarian Intervention*. Carlisle PA: U.S. Army War College.
- Stitt, T., 2000. *Notes from SHAPE Civil Military Cooperation Conference*. Mons, Belgium.
- Thomas, T., 2000. *Kosovo and the Current Myth of Information Superiority*. Carlisle PA: U.S. Army War College.
- USIP, 2000. *Promoting an Information Sharing Regime in Peace Support and Humanitarian Operations*. Washington DC: United States Institute of Peace.

Wentz, L., 1998. *Lessons from Bosnia: The IFOR Experience*. Washington DC: CCRP/NDU Press.

Wentz, L., 2000. *Notes from Kosovo visit May-June-July 2000*. Camp Bondsteel Kosovo: Task Force Falcon.

APPENDIX A

Military Technical Agreement

Military Technical Agreement Between the International Security Force (KFOR) and the Governments of the Federal Republic of Yugoslavia and the Republic of Serbia

Article I: General Obligations

1. The Parties to this Agreement reaffirm the document presented by President Ahtisaari to President Milosevic and approved by the Serb Parliament and the Federal Government on June 3, 1999, to include deployment in Kosovo under U.N. auspices of effective international civil and security presences. The Parties further note that the U.N. Security Council is prepared to adopt a resolution, which has been introduced, regarding these presences.

2. The State Governmental authorities of the Federal Republic of Yugoslavia and the Republic of Serbia understand and agree that the international security force (KFOR) will deploy following the adoption of the UNSCR referred to in paragraph 1 and operate without hindrance within Kosovo and with the authority to take all necessary action to establish and maintain a secure environment for all citizens of Kosovo and otherwise carry out its mission. They further agree to comply with all of the obligations of this Agreement and to facilitate the deployment and operation of this force.

3. For purposes of the agreement, the following expressions shall have the meanings as described below:

- a. *The Parties* are those signatories to the Agreement.

- b. *Authorities* means the appropriate responsible individual, agency, or organisation of the Parties.
- c. *FRY Forces* includes all of the FRY and Republic of Serbia personnel and organisations with a military capability. This includes regular army and naval forces, armed civilian groups, associated paramilitary groups, air forces, national guards, border police, army reserves, military police, intelligence services, federal and Serbian Ministry of Internal Affairs local, special, riot and anti-terrorist police, and any other groups or individuals so designated by the international security force (KFOR) commander.
- d. *The Air Safety Zone (ASZ)* is defined as a 25-kilometre zone that extends beyond the Kosovo province border into the rest of FRY territory. It includes the airspace above that 25-kilometre zone.
- e. *The Ground Safety Zone (GSZ)* is defined as a 5-kilometre zone that extends beyond the Kosovo province border into the rest of FRY territory. It includes the terrain within that 5-kilometre zone.
- f. *Entry into Force Day (EIF Day)* is defined as the day this Agreement is signed.

4. The purposes of these obligations are as follows:

- a. To establish a durable cessation of hostilities, under no circumstances shall any Forces of the FRY and the Republic of Serbia enter into, reenter, or remain within the territory of Kosovo or the Ground Safety Zone (GSZ) and the Air Safety Zone (ASZ) described in paragraph 3. Article I without the prior express consent of the international security force (KFOR) commander. Local police will be allowed to remain in the GSZ.

The above paragraph is without prejudice to the agreed return of FRY and Serbian personnel which will be the subject of a subsequent separate agreement as provided for in paragraph 6 of the document mentioned in paragraph 1 of this Article.

- b. To provide for the support and authorization of the international security force (KFOR) and in particular to authorize the international security force (KFOR) to take such actions as are required, including the use of necessary force, to ensure compliance with this Agreement and protection of the international security force (KFOR), and to contribute to a secure environment for the international civil implementation presence, and other international organisations, agencies, and non-governmental organizations (details in Appendix B).

Article II: Cessation of Hostilities

1. The FRY Forces shall immediately, upon entry into force (EIF) of this Agreement, refrain from committing any hostile or provocative acts of any type against any person in Kosovo and will order armed forces to cease all such activities. They shall not encourage, organise or support hostile or provocative demonstrations.

2. Phased Withdrawal of FRY Forces (ground): The FRY agrees to a phased withdrawal of all FRY Forces from Kosovo to locations in Serbia outside Kosovo. FRY Forces will mark and clear minefields, booby traps and obstacles. As they withdraw, FRY Forces will clear all lines of communication by removing all mines, demolitions, booby traps, obstacles and charges. They will also mark all sides of all minefields. International security forces' (KFOR) entry and deployment into Kosovo will be synchronized. The phased withdrawal of FRY Forces from Kosovo will be in accordance with the sequence outlined below:

- a. By EIF + 1 day, FRY Forces located in Zone 3 will have vacated, via designated routes, that Zone to demonstrate compliance (depicted on the map at Appendix A to the Agreement). Once it is verified that FRY forces have complied with this subparagraph and with paragraph 1 of this Article, NATO air strikes will be suspended. The suspension will continue provided that the obligations of this agreement are fully complied with, and provided that the UNSC adopts a resolution concerning the deployment of the international security force (KFOR) so rapidly that a security gap can be avoided.

- b. By EIF + 6 days, all FRY Forces in Kosovo will have vacated Zone 1 (depicted on the map at Appendix A to the Agreement). Establish liaison teams with the KFOR commander in Pristina.
 - c. By EIF + 9 days, all FRY Forces in Kosovo will have vacated Zone 2 (depicted on the map at Appendix A to the Agreement).
 - d. By EIF + 11 days, all FRY Forces in Kosovo will have vacated Zone 3 (depicted on the map at Appendix A to the Agreement).
 - e. By EIF +11 days, all FRY Forces in Kosovo will have completed their withdrawal from Kosovo (depicted on map at Appendix A to the Agreement) to locations in Serbia outside Kosovo, and not within the 5 km GSZ. At the end of the sequence (EIF + 11), the senior FRY Forces commanders responsible for the withdrawing forces shall confirm in writing to the international security force (KFOR) commander that the FRY Forces have complied and completed the phased withdrawal. The international security force (KFOR) commander may approve specific requests for exceptions to the phased withdrawal. The bombing campaign will terminate on complete withdrawal of FRY Forces as provided under Article II. The international security force (KFOR) shall retain, as necessary, authority to enforce compliance with this Agreement.
 - f. The authorities of the FRY and the Republic of Serbia will cooperate fully with international security force (KFOR) in its verification of the withdrawal of forces from Kosovo and beyond the ASZ/GSZ.
 - g. FRY armed forces withdrawing in accordance with Appendix A, i.e. in designated assembly areas or withdrawing on designated routes, will not be subject to air attack.
 - h. The international security force (KFOR) will provide appropriate control of the borders of FRY in Kosovo with Albania and FYROM (1) until the arrival of the civilian mission of the U.N.
3. Phased Withdrawal of Yugoslavia Air and Air Defence Forces (YAADF)

- a. At EIF + 1 day, no FRY aircraft, fixed wing and rotary, will fly in Kosovo airspace or over the ASZ without prior approval by the international security force (KFOR) commander. All air defence systems, radar, surface-to-air missile and aircraft of the Parties will refrain from acquisition, target tracking or otherwise illuminating international security (KFOR) air platforms operating in the Kosovo airspace or over the ASZ.
- b. By EIF + 3 days, all aircraft, radars, surface-to-air missiles (including man-portable air defence systems (MANPADS)) and anti-aircraft artillery in Kosovo will withdraw to other locations in Serbia outside the 25 kilometre ASZ.
- c. The international security force (KFOR) commander will control and coordinate use of airspace over Kosovo and the ASZ commencing at EIF. Violation of any of the provisions above, including the international security force (KFOR) commander's rules and procedures governing the airspace over Kosovo, as well as unauthorized flight or activation of FRY Integrated Air Defence (IADS) within the ASZ, are subject to military action by the international security force (KFOR), including the use of necessary force. The international security force (KFOR) commander may delegate control of normal civilian air activities to appropriate FRY institutions to monitor operations, deconflict international security force (KFOR) air traffic movements, and ensure smooth and safe operations of the air traffic system. It is envisioned that control of civil air traffic will be returned to civilian authorities as soon as practicable.

Article III: Notifications

1. This agreement and written orders requiring compliance will be immediately communicated to all FRY forces.
2. By EIF +2 days, the State governmental authorities of the FRY and the Republic of Serbia shall furnish the following specific information regarding the status of all FRY Forces:
 - a. Detailed records, positions and descriptions of all mines, unexploded ordnance, explosive devices, demolitions,

obstacles, booby traps, wire entanglement, physical or military hazards to the safe movement of any personnel in Kosovo laid by FRY Forces.

- b. Any further information of a military or security nature about FRY Forces in the territory of Kosovo and the GSZ and ASZ requested by the international security force (KFOR) commander.

Article IV: Establishment of a Joint Implementation Commission (JIC)

A JIC shall be established with the deployment of the international security force (KFOR) to Kosovo as directed by the international security force (KFOR) commander.

Article V: Final Authority to Interpret

The international security force (KFOR) commander is the final authority regarding interpretation of this Agreement and the security aspects of the peace settlement it supports. His determinations are binding on all Parties and persons.

Article VI: Entry Into Force

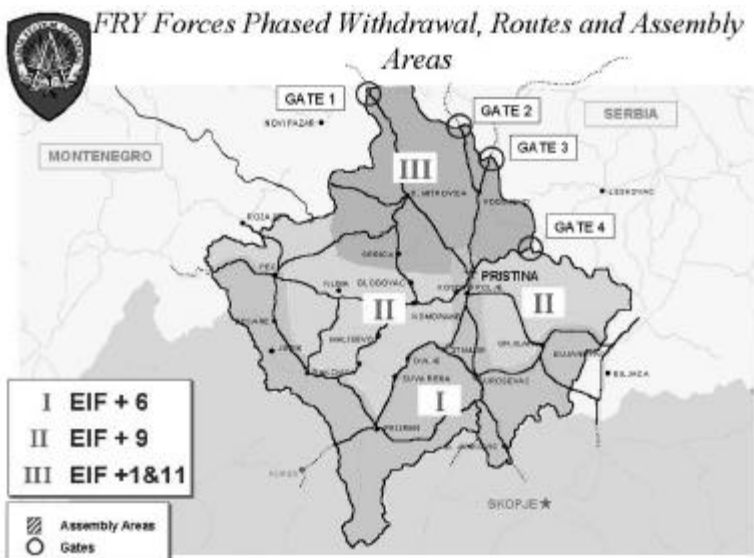

This agreement shall enter into force upon signature.

1. Consistent with the general obligations of the Military Technical Agreement, the State Governmental authorities of the FRY and the Republic of Serbia understand and agree that the international security force (KFOR) will deploy and operate without hindrance within Kosovo and with the authority to take all necessary action to establish and maintain a secure environment for all citizens of Kosovo.
2. The international security force (KFOR) commander shall have the authority, without interference or permission, to do all that he judges necessary and proper, including the use of military force, to protect the international security force (KFOR), the international civil implementation presence, and to carry out the responsibilities inherent in this Military Technical Agreement and the Peace Settlement which it supports.
3. The international security force (KFOR) nor any of its personnel or staff shall be liable for any damages to public or private property that they may cause in the course of duties related to the implementation of this Agreement. The parties will agree a Status of Forces Agreement (SOFA) as soon as possible.
4. The international security force (KFOR) shall have the right:
 - a. To monitor and ensure compliance with this Agreement and to respond promptly to any violations and restore compliance, using military force if required.

This includes necessary actions to:

1. Enforce withdrawals of FRY forces.
2. Enforce compliance following the return of selected FRY personnel to Kosovo.
3. Provide assistance to other international entities involved in the implementation or otherwise authorised by the UNSC.
 - b. To establish liaison arrangements with local Kosovo authorities, and with FRY/Serbian civil and military authorities.

c. To observe, monitor and inspect any and all facilities or activities in Kosovo that the international security force (KFOR) commander believes has or may have military or police capability, or may be associated with the employment of military or police capabilities, or are otherwise relevant to compliance with this Agreement.

5. Notwithstanding any other provision of this Agreement, the Parties understand and agree that the international security force (KFOR) commander has the right and is authorised to compel the removal, withdrawal, or relocation of specific Forces and weapons, and to order the cessation of any activities whenever the international security force (KFOR) commander determines a potential threat to either the international security force (KFOR) or its mission, or to another Party. Forces failing to redeploy, withdraw, relocate, or to cease threatening or potentially threatening activities following such a demand by the international security force (KFOR) shall be subject to military action by the international security force (KFOR), including the use of necessary force, to ensure compliance.

Turkey recognizes the Republic of Macedonia with its constitutional name.

APPENDIX B

United Nations Security Council Resolution 1244 (1999)

UNSCR 1244 Adopted by the Security Council at its 4011th meeting, on 10 June 1999

The Security Council,

Bearing in mind the purposes and principles of the Charter of the United Nations, and the primary responsibility of the Security Council for the maintenance of international peace and security,

Recalling its resolutions 1160 (1998) of 31 March 1998, 1199 (1998) of 23 September 1998, 1203 (1998) of 24 October 1998 and 1239 (1999) of 14 May 1999,

Regretting that there has not been full compliance with the requirements of these resolutions,

Determined to resolve the grave humanitarian situation in Kosovo, Federal Republic of Yugoslavia, and to provide for the safe and free return of all refugees and displaced persons to their homes,

Condemning all acts of violence against the Kosovo population as well as all terrorist acts by any party,

Recalling the statement made by the Secretary-General on 9 April 1999, expressing concern at the humanitarian tragedy taking place in Kosovo,

Reaffirming the right of all refugees and displaced persons to return to their homes in safety,

Recalling the jurisdiction and the mandate of the International Tribunal for the Former Yugoslavia,

Welcoming the general principles on a political solution to the Kosovo crisis adopted on 6 May 1999 (S/1999/516, annex 1 to this resolution) and welcoming also the acceptance by the Federal Republic of Yugoslavia of the principles set forth in points 1 to 9 of the paper presented in Belgrade on 2 June 1999 (S/1999/649, annex 2 to this resolution), and the Federal Republic of Yugoslavia's agreement to that paper,

Reaffirming the commitment of all Member States to the sovereignty and territorial integrity of the Federal Republic of Yugoslavia and the other States of the region, as set out in the Helsinki Final Act and annex 2,

Reaffirming the call in previous resolutions for substantial autonomy and meaningful self-administration for Kosovo,

Determining that the situation in the region continues to constitute a threat to international peace and security,

Determined to ensure the safety and security of international personnel and the implementation by all concerned of their responsibilities under the present resolution, and acting for these purposes under Chapter VII of the Charter of the United Nations,

1. Decides that a political solution to the Kosovo crisis shall be based on the general principles in annex 1 and as further elaborated in the principles and other required elements in annex 2;
2. Welcomes the acceptance by the Federal Republic of Yugoslavia of the principles and other required elements referred to in paragraph 1 above, and demands the full cooperation of the Federal Republic of Yugoslavia in their rapid implementation;
3. Demands in particular that the Federal Republic of Yugoslavia put an immediate and verifiable end to violence and repression in Kosovo, and begin and complete verifiable phased withdrawal from Kosovo of all military, police and paramilitary forces according to a rapid timetable, with which the deployment of the international security presence in Kosovo will be synchronized;

4. Confirms that after the withdrawal an agreed number of Yugoslav and Serb military and police personnel will be permitted to return to Kosovo to perform the functions in accordance with annex 2;
5. Decides on the deployment in Kosovo, under United Nations auspices, of international civil and security presences, with appropriate equipment and personnel as required, and welcomes the agreement of the Federal Republic of Yugoslavia to such presences;
6. Requests the Secretary-General to appoint, in consultation with the Security Council, a Special Representative to control the implementation of the international civil presence, and further requests the Secretary-General to instruct his Special Representative to coordinate closely with the international security presence to ensure that both presences operate towards the same goals and in a mutually supportive manner;
7. Authorizes Member States and relevant international organizations to establish the international security presence in Kosovo as set out in point 4 of annex 2 with all necessary means to fulfil its responsibilities under paragraph 9 below;
8. Affirms the need for the rapid early deployment of effective international civil and security presences to Kosovo, and demands that the parties cooperate fully in their deployment;
9. Decides that the responsibilities of the international security presence to be deployed and acting in Kosovo will include:
 - a. Deterring renewed hostilities, maintaining and where necessary enforcing a ceasefire, and ensuring the withdrawal and preventing the return into Kosovo of Federal and Republic military, police and paramilitary forces, except as provided in point 6 of annex 2;
 - b. Demilitarizing the Kosovo Liberation Army (KLA) and other armed Kosovo Albanian groups as required in paragraph 15 below;
 - c. Establishing a secure environment in which refugees and displaced persons can return home in safety, the international

- civil presence can operate, a transitional administration can be established, and humanitarian aid can be delivered;
- d. Ensuring public safety and order until the international civil presence can take responsibility for this task;
 - e. Supervising demining until the international civil presence can, as appropriate, take over responsibility for this task;
 - f. Supporting, as appropriate, and coordinating closely with the work of the international civil presence;
 - g. Conducting border monitoring duties as required;
 - h. Ensuring the protection and freedom of movement of itself, the international civil presence, and other international organizations;
10. Authorizes the Secretary-General, with the assistance of relevant international organizations, to establish an international civil presence in Kosovo in order to provide an interim administration for Kosovo under which the people of Kosovo can enjoy substantial autonomy within the Federal Republic of Yugoslavia, and which will provide transitional administration while establishing and overseeing the development of provisional democratic self-governing institutions to ensure conditions for a peaceful and normal life for all inhabitants of Kosovo;
11. Decides that the main responsibilities of the international civil presence will include:
- a. Promoting the establishment, pending a final settlement, of substantial autonomy and self-government in Kosovo, taking full account of annex 2 and of the Rambouillet accords (S/1999/648);
 - b. Performing basic civilian administrative functions where and as long as required;
 - c. Organizing and overseeing the development of provisional institutions for democratic and autonomous self-government pending a political settlement, including the holding of elections;

- d. Transferring, as these institutions are established, its administrative responsibilities while overseeing and supporting the consolidation of Kosovo's local provisional institutions and other peace-building activities;
 - e. Facilitating a political process designed to determine Kosovo's future status, taking into account the Rambouillet accords (S/1999/648);
 - f. In a final stage, overseeing the transfer of authority from Kosovo's provisional institutions to institutions established under a political settlement;
 - g. Supporting the reconstruction of key infrastructure and other economic reconstruction;
 - h. Supporting, in coordination with international humanitarian organizations, humanitarian and disaster relief aid;
 - i. Maintaining civil law and order, including establishing local police forces and meanwhile through the deployment of international police personnel to serve in Kosovo;
 - j. Protecting and promoting human rights;
 - k. Assuring the safe and unimpeded return of all refugees and displaced persons to their homes in Kosovo;
12. Emphasizes the need for coordinated humanitarian relief operations, and for the Federal Republic of Yugoslavia to allow unimpeded access to Kosovo by humanitarian aid organizations and to cooperate with such organizations so as to ensure the fast and effective delivery of international aid;
13. Encourages all Member States and international organizations to contribute to economic and social reconstruction as well as to the safe return of refugees and displaced persons, and emphasizes in this context the importance of convening an international donors' conference, particularly for the purposes set out in paragraph 11g above, at the earliest possible date;

14. Demands full cooperation by all concerned, including the international security presence, with the International Tribunal for the Former Yugoslavia;

15. Demands that the KLA and other armed Kosovo Albanian groups end immediately all offensive actions and comply with the requirements for demilitarization as laid down by the head of the international security presence in consultation with the Special Representative of the Secretary-General;

16. Decides that the prohibitions imposed by paragraph 8 of resolution 1160 (1998) shall not apply to arms and related matériel for the use of the international civil and security presences;

17. Welcomes the work in hand in the European Union and other international organizations to develop a comprehensive approach to the economic development and stabilization of the region affected by the Kosovo crisis, including the implementation of a Stability Pact for South Eastern Europe with broad international participation in order to further the promotion of democracy, economic prosperity, stability and regional cooperation;

18. Demands that all States in the region cooperate fully in the implementation of all aspects of this resolution;

19. Decides that the international civil and security presences are established for an initial period of 12 months, to continue thereafter unless the Security Council decides otherwise;

20. Requests the Secretary-General to report to the Council at regular intervals on the implementation of this resolution, including reports from the leaderships of the international civil and security presences, the first reports to be submitted within 30 days of the adoption of this resolution;

21. Decides to remain actively seized of the matter.

Annex 1

Statement by the Chairman on the conclusion of the meeting of the G-8 Foreign Ministers held at the Petersberg Centre on 6 May 1999:

The G-8 Foreign Ministers adopted the following general principles on the political solution to the Kosovo crisis:

- Immediate and verifiable end of violence and repression in Kosovo;
- Withdrawal from Kosovo of military, police and paramilitary forces;
- Deployment in Kosovo of effective international civil and security presences, endorsed and adopted by the United Nations, capable of guaranteeing the achievement of the common objectives;
- Establishment of an interim administration for Kosovo to be decided by the Security Council of the United Nations to ensure conditions for a peaceful and normal life for all inhabitants in Kosovo;
- The safe and free return of all refugees and displaced persons and unimpeded access to Kosovo by humanitarian aid organizations;
- A political process towards the establishment of an interim political framework agreement providing for a substantial self-government for Kosovo, taking full account of the Rambouillet accords and the principles of sovereignty and territorial integrity of the Federal Republic of Yugoslavia and the other countries of the region, and the demilitarization of the KLA;
- Comprehensive approach to the economic development and stabilization of the crisis region.

Annex 2

Agreement should be reached on the following principles to move towards a resolution of the Kosovo crisis:

1. An immediate and verifiable end of violence and repression in Kosovo.
2. Verifiable withdrawal from Kosovo of all military, police, and paramilitary forces according to a rapid timetable.

3. Deployment in Kosovo under United Nations auspices of effective international civil and security presences, acting as may be decided under Chapter VII of the Charter, capable of guaranteeing the achievement of common objectives.

4. The international security presence with substantial North Atlantic Treaty Organization participation must be deployed under unified command and control and authorized to establish a safe environment for all people in Kosovo and to facilitate the safe return to their homes of all displaced persons and refugees.

5. Establishment of an interim administration for Kosovo as a part of the international civil presence under which the people of Kosovo can enjoy substantial autonomy within the Federal Republic of Yugoslavia, to be decided by the Security Council of the United Nations. The interim administration to provide transitional administration while establishing and overseeing the development of provisional democratic self-governing institutions to ensure conditions for a peaceful and normal life for all inhabitants in Kosovo.

6. After withdrawal, an agreed number of Yugoslav and Serbian personnel will be permitted to return to perform the following functions:

- Liaison with the international civil mission and the international security presence;
- Marking/clearing minefields;
- Maintaining a presence at Serb patrimonial sites;
- Maintaining a presence at key border crossings.

7. Safe and free return of all refugees and displaced persons under the supervision of the Office of the United Nations High Commissioner for Refugees and unimpeded access to Kosovo by humanitarian aid organizations.

8. A political process towards the establishment of an interim political framework agreement providing for substantial self-government for Kosovo, taking full account of the Rambouillet accords and the principles of sovereignty and territorial integrity of the Federal Republic of Yugoslavia and the other countries of the region, and the demilitarization of UCK. Negotiations between the parties for a

settlement should not delay or disrupt the establishment of democratic self-governing institutions.

9. A comprehensive approach to the economic development and stabilization of the crisis region. This will include the implementation of a stability pact for South-Eastern Europe with broad international participation in order to further promotion of democracy, economic prosperity, stability and regional cooperation.

10. Suspension of military activity will require acceptance of the principles set forth above in addition to agreement to other, previously identified, required elements, which are specified in the footnote below.¹ A military-technical agreement will then be rapidly concluded that would, among other things, specify additional modalities, including the roles and functions of Yugoslav/Serb personnel in Kosovo:

Withdrawal

- Procedures for withdrawals, including the phased, detailed schedule and delineation of a buffer area in Serbia beyond which forces will be withdrawn;

Returning personnel

- Equipment associated with returning personnel;
- Terms of reference for their functional responsibilities;
- Timetable for their return;
- Delineation of their geographical areas of operation;
- Rules governing their relationship to the international security presence and the international civil mission.

Notes

Other required elements:

- A rapid and precise timetable for withdrawals, meaning, e.g., 7 days to complete withdrawal and air defence weapons withdrawn outside a 25 kilometre mutual safety zone within 48 hours;

- Return of personnel for the four functions specified above will be under the supervision of the international security presence and will be limited to a small agreed number (hundreds, not thousands);
- Suspension of military activity will occur after the beginning of verifiable withdrawals;
- The discussion and achievement of a military-technical agreement shall not extend the previously determined time for completion of withdrawals.

APPENDIX C

Acronym List

A

AAFES Army and Air Force Exchange Service

AAR After Action Review

ABC American Broadcasting Company

ABCCC Airborne Battlefield Command and Control Center

ACE Allied Command Europe

ACE Analysis and Control Element

ACOS Assistant Chief of Staff

ACT Analysis Control Team

AC2ISRC Aerospace Command and Control and Intelligence, Surveillance, and Reconnaissance Center

AD Armored Division

ADAM Air Defense and Airspace Management Directorate

ADAMS A Digital Avionics Methodology Schema

ADCON Administrative Control

AFAC Airborne Forward Air Controller

AFN Armed Forces Network

AFSOUTH Allied Forces, Southern Europe

AIRSOUTH Allied Air Forces Southern Europe

AJP-9 Allied Joint Publication #9, *NATO Civil-Military Cooperation (CIMIC) Doctrine* (4th Study Draft), July 2000

ALO Air Liaison Officer

AMF ACE Mobile Force, Allied Mobile Force

AMF (L) ACE Mobile Force (Land)

AMIB Allied MI Battalion

AMPS Automated Mission Planning System

AO Area of Operation

AOR Area of Responsibility

APOE Aerial Port of Embarkation

APV Armored Personnel Vehicles

ARRC Allied Command Europe Rapid Reaction Corps (NATO)

ASD(C3I) Assistant Secretary of Defense (Command, Control, Communications, and Intelligence)

ASG Area Support Group

ASZ Air Safety Zone

ATM Air Tasking Message

ATM Air Traffic Management

ATO Air Tasking Order

AUTODIN Automatic Digital Network

AUTOFU Automated Funkmess (radar) (German tactical systems)

AUTOKO Automated Corps (German tactical system)

AWACS Airborne Warning and Control System

B

BDA Battle Damage Assessment
BDE Brigade
BDU Battle Dress Uniform
BRAs Bubbas Running Around
BSMC Balkans Spectrum Management Cell
BUB Battle Update Briefing

C

C2PC Command and Control Personal Computer
C3 Command, Control, and Communications
C3I Command, Control, Communications, and Intelligence
C4ISR Command, Control, Communications, Computers, Intelligence, Surveillance, and Reconnaissance
CA Civil Affairs
CAC Crisis Action Cell
CALL Center for Army Lessons Learned
CAOC Combined Aerospace Operations Center
CAS Camp Able Sentry
CAS Close Air Support
CAT Computer Aided Translation
CCIR Commander's Critical Information Requirements
CCRP Command and Control Research Program

CEC Central Election Commission

CECOM Communications-Electronics Command

CERT Computer Emergency Response Teams

CEU Commission of the European Union

CFMU Central Flow Management Unit

CHATS CI/HUMINT Automated Tool Set

CHE Complex Humanitarian Emergencies

CIA Central Intelligence Agency

CID Combat Identification

CID Criminal Investigation Division

CI Counterintelligence

CIM Chief of the Implementation Mission

CIMIC Civil-Military Cooperation

CINC Commander in Chief

CINCEUCOM Commander in Chief, United States European Command

CINCSOUTH Commander-in-Chief, Allied Forces Southern Europe

CINCUSNAVEUR Commander-in-Chief, U.S. Navy, Europe

CIS Communications and Information Systems

CISCC CIS Control Center

CIVPOL Civilian Police

CJCMTF Combined Joint Civil-Military Task Force

CMD Command

CMO Civil-Military Operations

CNA Computer Network Attack

CNBC Consumer News and Business Channel

CNN Commercial News Network

CODAN Carrier Operated Device, Anti-Noise

COE Council of Europe

COMINT Communications Intelligence

COMKFOR Commander, Kosovo Force

COMMZ Communications Zone

COMSEC Communications Security

CONOPS Contingency Operations

CONUS Continental United States

COYOTE Canadian Surveillance System

CPIC Coalition Press Information Center

CRC Combat Replacement Center

CSCI Commercial Satellite Communications Initiative

CSIS Center for Strategic and International Studies

C-SPAN Cable Satellite Public Affairs Network

CTAPS Contingency Theater Air Control System Automated Planning System

CUDN Common User Data Network

D

DAMA Demand Assigned Multiple Access

DANIDA Danish Aid Agency

DASH Deployable Automation Support Host

DCSINT Deputy Chief of Staff for Intelligence

DCSLOG Deputy Chief of Staff for Logistics

DEAD Destroying Enemy Air Defense Systems

DENCAP Dental Civic Action Program

DFAC Dining Facility (Administration Center)

DFSCOORD Deputy Fire Support Coordinator

DIA Defense Intelligence Agency

DISA Defense Information Systems Agency

DISA-EUR Defense Information Systems Agency—Europe

DISN Defense Information Systems Network

DoD Department of Defense

DOIM Directorate of Information Management

DOS Department of State

DP Displaced Persons

DPKO Department of Peacekeeping Operations

DRSN Defense Red Switched Network

DSACEUR Deputy Supreme Allied Commander, Europe

DSCS Defense Satellite Communications System

DSN Defense Switched Network

DTG Date-Time Group

DTG Digital Transmission Group

DTRAC DataTrac (Information tracking systems manufacturer)

E

EAC Echelons Above Corps

EADRCC Euro Atlantic Disaster Response Coordination Center

EAPC Euro-Atlantic Partnership Council

EBU European Broadcasting Union

ECAC Election Complaints and Appeals sub-Commission

ECB Echelons Corps and Below

ECHO European Community Humanitarian Organisation

EIF Entry into Force

EJS Emergency Judicial System

ELINT Electronic Intelligence

EMG Emergency Management Group

EOD Explosive Ordnance Disposal

EPS Elektroprivreda Srbije (Serbian Electricity Provider)

ERT Emergency Response Team

EU European Union

EUCOM United States European Command

EURCERT Europe Computer Emergency Response Team

EUROCONTROL European Organisation for the Safety of Air Navigation

EUROCORPS European multinational army corps

EW Electronic Warfare

EWS Expeditionary Weather Squadron

F

FAADCS Fleet accounting and disbursing centers

FAC Forward Air Controllers

FAP Fly Away Package

FEMA Federal Emergency Management Agency

FHT Field HUMINT Team

FM Force Module

FM Frequency Modulation

FMD Flow Management Division

FOB Forward Operating Base

FRAGO Fragmentary Order

FRY Federal Republic of Yugoslavia

FSE Fire Support Element

FSO Fire Support Officers

FST Field Support Team

FYROM Former Yugoslav Republic of Macedonia

G

G2X General staff for HUMINT coordination

GCCS Global Command and Control System

GFSU Greek Force Support Unit

GIS Geographic Information System

GP Group

GPS Global Positioning System

GSA General Services Administration

GSA General Support Artillery

GSM Ground Station Module

GSZ Ground Safety Zone

H

HA Humanitarian Assistance

HARM High-Speed Anti-Radiation Missile

HCIC Humanitarian Community Information Center

HESCO Brand name: Hesco Bastion Concertainer® Defense Wall

HF High Frequency

HMMWV High Mobility Multipurpose-Wheeled Vehicles

HOC Human Intelligence (HUMINT) Operations Cell

HQ Headquarters

HS-MUX High-Speed Multiplexers

HUMINT Human Intelligence

I

IAC Interim Administrative Council

IADS Integrated Air Defense System

IATA International Air Transport Association

IC Information Campaign

ICAO International Civil Aviation Organization

ICITAP International Crime Investigative Training Assistance Program

ICRC Intelligence Contingency Readiness Center

ICRC International Committee of the Red Cross

ICTC International CIMIC Training Center

ID Identification

IDA Institute for Defense Analyses

IDNX Integrated Data (Digital) Network Exchange

IDP Internally Displaced Person

IDR Initial Design Review

IFONE Telecommunications service provider

IFOR Implementation Force

IMF International Monetary Fund

IMINT Imagery Intelligence

IMS Information Management System

IMS International Military Staff

INFOSEC Information Security

INMARSAT International Mobile Satellite Communications Company

INSS Institute for National Strategic Studies

INTELINK SCI level Web-based access

INTELINK-S Secret-level component of Intelink

INTSUM Intelligence Summary

IO Information Operations

IO International Organization

IOM International Organization for Migration
IOR Indian Ocean Region (location of GEO satellites)
IOWG Information Operations Working Group
IPB Intelligence Preparation of the Battlespace
IPKO Internet Project Kosovo
IR Information Requests
IRC International Rescue Committee
IRIDIUM German satellite telecommunications system
IRT Individual Readiness Training
ISB Intermediate Staging Base
ISP Internet Service Provider
ITC Irish Transport Company
IVSN Initial Voice Switched Network

J

J-2 Intelligence (Joint Staff Directorate)
JAT Joint Analysis Team
JCC Joint Civil Commission
JCCC Joint Communications Control Center
JDISS Joint Deployable Intelligence Support System
JEOC Joint Elections Operation Center
JFACC Joint Forces Air Component Command
JFLCC Joint Forces Land Component Command
JFMCC Joint Forces Maritime Component Command

JIAS Joint Interim Administrative Structure

JIC Joint Implementation Commission

JOC Joint Operations Center

JOIS Joint Operations/ Intelligence Information System

JSC Joint Security Committee

JSEAD Joint Suppression of Enemy Air Defense

JSTARS Joint Surveillance Target Attack Radar System

JTF Joint Task Force

JTIDS Joint Tactical Information Distribution System

JVB Joint Visitors Bureau

K

KDG Kosovo Development Group

KFOR Kosovo Force

KLA Kosovo Liberation Army

KPC Kosovo Protection Corps

KPN Netherlands Postal and Telecommunications Services

KPS Kosovo Police Service

KPSS Kosovo Police Service School

KRIS Kosovo Repatriation Information Support

KSN KFOR Secret Network

KTC Kosovo Transitional Council

KU Ku Frequency Band

KVM Kosovo Verification Mission

L

LAN Local Area Network

LANDCENT Allied Land Forces Central Europe

LBD United Democratic Movement

LCAC Landing Craft Air Cushion

LDK Democratic League of Kosovo

LIWA Land Information Warfare Activity

LNO Liaison Officer

LOCE Linked Operations-Intelligence Centers Europe

M

MA Municipal Administrator

MAAP Master Air Attack Plan

MACC Mine Action Coordination Center

MANPAD Man-Portable Air Defense System

MASH Mobile Army Surgical Hospital

MASINT Measurement and Signature Intelligence

MCM Mobile Communications Module

MCU Multipoint Control Unit

MDMP Military Decisionmaking Process

MEDCAP Medical Civic Action Program

MEDEVAC Medical Evacuation

METL Mission-Essential Task List

MEU Marine Expeditionary Unit

MI Military Intelligence

MILSATCOM Military Satellite Communications

MITEL Canadian telecommunications company

MLRS Multiple Launched Rocket System

MNB Multinational Brigade

MNB-C Multinational Brigade (Central)

MNB-E Multinational Brigade (East)

MNB-N Multinational Brigade (North)

MNB-S Multinational Brigade (South)

MNB-W Multinational Brigade (West)

MND Multinational Divisions

MNICC Multinational Intelligence Coordination Cell

MOBTEL Mobile Telecommunications (Yugoslavian company)

MOC Media Operations Center

MOD Minister (Ministry) of Defense

MoE Measure of Effectiveness

MoM Measure of Merit

MOU Memorandum of Understanding

MP Military Police

MPAD Mobile Public Affairs Detachment

MRE Meal Ready-to-eat

MRE Mission Rehearsal Exercises

MRP Ministry of Public Order

MSE Mobile Subscriber Equipment

MSF Medecins sans Frontieres

MSNBC Microsoft/ National Broadcasting Company

MSU Multinational Specialized Unit

MTA Military Training Agreement

MTA Governments of the Federal Republic of Yugoslavia and the Republic of Serbia

MTI Moving Target Indicator

MUP Ministry of Internal Affairs Police (translation)

MWR Morale, Welfare, and Recreation

N

NAC North Atlantic Council

NAC2 NATO Air Command and Control

NACOSA NATO CIS Operating and Supporting Agency

NAEW NATO Airborne Early Warning

NAMIS NATO Automated Meteorological Information System

NAMSA NATO Maintenance and Supply Agency

NATMC NATO Air Traffic Management Center

NATO North Atlantic Treaty Organization

NC3A Nuclear Command, Control, and Communications (C3) Assessment

NCO Non-Commissioned Officer

NDU National Defense University

NEWSKY Commercial satellite communications provider

NGO Non-governmental Organization

NIC National Intelligence Cells

NIC National Intelligence Council

NIDTS NATO Initial Data Transfer System

NIMA National Imagery and Mapping Agency

NIPRNET Nonsecure Internet Protocol Router Network

NIST National Intelligence Support Team

NSA National Security Agency

NSA NATO Standardization Agency

NSE National Support Elements

O

OAF Operation Allied Force

OASD Office of the Assistant Secretary of Defense

ODCSIM Office of the Deputy Chief of Staff, Information Management

OHR Office of the High Representative

OIC Officer in Charge

OJG Operation Joint Guardian

OmniTrac Commercial Satellite Tracking System

OPCOM Operational Command

OPCON Operational Control

OPLAN Operations Plans

OPORD Operations Order

OPSEC Operations Security

OPTEMPO Operations Tempo

OSCE Organization for Security and Cooperation in Europe

OSINT Open-Source Intelligence

P

PA Public Affairs

PABX Private Automatic Branch Exchange

PACOM Pacific Command

PAG Public Affairs Guidelines

PAIS Public Affairs Information Service

PAO Public Affairs Officer

PASOS Portable Automated Surface Observing System

PBX Public Telephone Switching

P/DSRSG Principal Deputy Special Representative of the Secretary General

PDD Presidential Decision Directives

PfP Partnership for Peace

PGOK Provisional Government of Kosovo

PI Point of Impact

PI Procedural Item

PIO Public Information Officer

PIR Primary Intelligence Requirements

PIR Priority Intelligence Requirements

PJP MUP Specialized Units

PMSVS Pilot to Meteorological Service Voice System

POLAD Political Advisor

POP Point of Presence

POW Prisoner of War

PPDK Party for Democratic Progress in Kosovo

Promina Commercial networking system provided by Logistica Telecom

PSE PSYOP Support Element

PSO Peace Support Operations

PSYOP Psychological Operations

PT Physical Training

Ptarmigan British Army military radios

PTK Kosovo Public Telecommunications

PTT Postal, Telephone, and Telegraph Services

PVO Private Voluntary Organization

PX Post Exchange

Q

QRF Quick Reaction Force

R

RAND Research and Development

RATT Radio Teletype

RELNATO Releasable Intelligence NATO
RELKFOR Releasable Intelligence KFOR
RELSFOR Releasable Stabilization Forces
RFMC Regional Frequency Management Cell
RIP Replacements in Place
RJEOC Regional Joint Election Operation Cell
RMWS Remote Miniature Weather Station
RSO Receiving, Staging, and Onward Moving
RSO Regional Security Officer
RTK Radio Television Kosovo
RTS Radio Television Serbia
RVA Rapid Village Assessment

S

SA Security Assistance
SA Selective Availability (GPS)
SA Senior Advisor
SA Situational Awareness
SACEUR Supreme Allied Commander Europe
SACLANT Supreme Allied Commander Atlantic
SAJ MUP Special Anti-terrorist Units
SAM Surface to Air Missiles
SATCOM Satellite Communications
SC SIGNIT Correlation

SCI Sensitive Compartmented Information

SEAhuts Southeast Asia Huts

SETAF Southern European Task Force

SFOR Stabilization Force

SHAPE Supreme Headquarters Allied Powers, Europe

SIGINT Signals Intelligence

SINGARS Single-Channel Ground and Airborne Radio System

SIPRNET Secret Internet Protocol Router Network

SITREP Situation Report

SNC Serbian National Council

SOCCE Special Operations Command and Control Element

SOF Special Operations Forces

SOP Standard Operating Procedure

SpaceLink Commercial satellite communications company

SPOD Sea Port of Debarkation

SPOE Sea Port of Embarkation

SPRINT Special Psychiatric Rapid Intervention Team

SPS Socialist Party of Serbia

SRSG Special Representative of the Secretary General

STEP Standard Tactical Entry Point

STU-III Secure Telephone Unit III

SWO Staff Weather Operations

T

TACMET Tactical Meteorological

TACOM Tactical Command

TACON Tactical Control

TACSAT Tactical Satellite

TAMSCO American telecommunications company

TEMA Training, Education, and Mutual Assistance

TF Task Force

TFCICA Task Force CI Coordinating Activity

TFE Task Force Eagle

TFF Task Force Falcon

TFMC Theater Frequency Management Cell

TMK Kosovo Protection Corps (Trupat E Mbrojtjes se Kosoves)

TOA Transfer of Authority

TOC Tactical Operations Center

TO&E Tables of Organization and Equipment

TPN Tactical Packet Network

TPT Tactical PSYOP Team

TRANSEC Transmission Security

TRAP Tactical Recovery of Aircraft and Personnel

TROPO Troposphere

TRRIP Theater Rapid Response Intelligence Package

TRW Thompson Ramo-Wooldridge Company

TSM Target Synchronization Matrix

TST Tactical Support Team

U

UAE United Arab Emirates

UAV Unmanned aerial vehicles

UCK *Ushtria Clirimtare E Kosoves*

UCMJ (United States) Uniform Code of Military Justice

UCPMB Former UCK/KLA (Liberation Army of Prescvo, Medcedja, and Bujanovac)

UHF Ultrahigh Frequency

UNHCR United Nations High Commissioner for Refugees

UNITAF Unified Task Force

UNMIK United Nations Interim Administration Mission in Kosovo

UNMIK-P United Nations Interim Administration Mission in Kosovo Police

UNOSOM II United Nations Operation in Somalia II

UNPROFOR United Nations Protection Force

UNSCR United Nations Security Council Resolution(s)

UNTAES United Nations Transitional Administration in Eastern Slavonia (Baranja and Western Sirium)

UPS Uninterrupted Power Sources

USA United States Army

USACAPOC U.S. Army Civil Affairs and Psychological Operations Command

USAF United States Air Force

USAFE United States Air Force, Europe

USAFE/SA United States Air Forces Europe Studies and Analysis

USAID United States Agency for International Development

USAREUR United States Army, European Command

USCINCEUR Commander-in-Chief of U.S. European Command

USEUCOM United States European Command

USGS U.S. Geological Survey

USIA U.S. Information Agency

USKFOR United States Kosovo Force

USMC United States Marine Corps

USN United States Navy

USNAVEUR United States Naval Forces Europe

UXO Unexploded Explosive Ordinance

V

VERP Village Employment Rehabilitation Program

VJ Yugoslavian Army

VSAT Very Small Aperture Terminal

VTC Video Teleconferencing

W

WAC Weapons Authorization Card

WAN Wide-Area Network

WPC Warrior Preparation Center

X

XP DCS/Plans (USAF)

Y

YAADF Yugoslavia Air and Air Defense Forces

Z

ZOS Zone of Separation

ABOUT THE AUTHORS

Walter S. Clarke is a retired Foreign Service Officer (1958-94) and Political reporting specialist. Five regular tours of duty in Africa (Burundi, Cameroon, Cote d'Ivoire, Djibouti, and Nigeria), two in Latin America (Costa Rica and Colombia), and in Spain; State Department Advisor at the U.S. Naval War College (87-89) and member of strategy department faculty at the U.S. Army War College (92-94); Deputy Head of the U.S. Liaison Office in Mogadishu (and political advisor to the U.S. force commander) for the last two months of UNITAF and the first two months of UNOSOM II; Adjunct Professor of Peace Operations, U.S. Army Peacekeeping Institute. In retirement, Mr. Clarke has served as independent consultant on exercise planning, execution and senior role play in the U.S., SOUTHCOM, EUCOM and PACOM theaters. The exercises included mission rehearsal exercises for several U.S. contingents going to MND (E) and NATO headquarters units in KFOR-IV and KFOR-V. Mr. Clarke has published numerous articles on Somalia, Central Africa and peace operation strategy and planning in academic and professional military publications; he co-edited (with Dr. Jeffrey Herbst) *Learning from Somalia: Lessons of Armed Humanitarian Intervention* (Westview Press, 1997).

Rich DuBreuil, Major USA, SC APMS, Clemson University Army ROTC and Task Force Falcon Election Officer and Deputy GS Plans Chief, 2A Rotation.

C. Patrick Duecy is a career U.S. Defense Intelligence Senior Executive Service officer, has served as head of NATO Headquarters Intelligence since August 1997. He is the first U.S. intelligence officer and the first civilian to hold the post. Mr. Duecy served at SHAPE during 1993-1997 and previously held various positions in the Defense Intelligence Agency.

Jusuf Fuduli spent 12 months as the Political Analyst for the U.S. Army contingent of KFOR from December 1999 to Dec 2000; a period in which he covered the first free and democratic elections in Kosovo's

history. A student of Balkan history and the son of Albanian and Montenegrin parents, Mr. Fuduli was a distinguished Honor Graduate when he received his BA in History from the City University of New York, and is currently enrolled in the MA in international Affairs program at American University.

CPT Alton L. Gwaltney, III is resently assigned as Director, Training and Support, Center for Law and Military Operations, The Judge Advocate General's School, United States Army. B.A., 1990, Hampden-Sydney College; J.D., 1993, T.C. Williams School of Law at The University of Richmond. Formerly assigned as the Deputy Legal Advisor, Task Force Falcon, Kosovo, 1999-2000; Chief, International and Operational Law and Senior Trial Counsel, 1st Infantry Division, Wuerzburg, Germany 1998-99; Trial Counsel and Administrative Law Attorney, V Corps, Hanau Branch Office, Germany 1997-98; Trial Counsel, 19th Theater Army Area Command, Taegu, Korea 1994-96. Member of the Bar of the Commonwealth of Virginia.

Christopher Holshek, Lt. Col., U.S. Army Civil Affairs, was deployed from the 304th Civil Affairs Brigade, Philadelphia, PA, to HQ KFOR February-October 2000 and served as a KFOR CIMIC Liaison Officer to UNMIK Civil Administration (Pillar II). Prior to that, he has had extensive experience in the planning and deployment of U.S. Army Civil Affairs forces to the Balkans. He has also served with the United Nations in a civilian capacity as a Logistics Officer during all phases of the UN Transitional Administration in Eastern Slavonia (UNTAES) mission in Croatia. The Brigade Civil Information Officer, he returned to Kosovo last December as a civilian to serve with UNMIK as a Political Affairs Reporting Officer at the Office of the SRSO in Pristina.

Molly Inman recently joined the Potomac Institute for Policy Studies in Arlington, Virginia as a research associate. Prior to joining the Institute, she was a Smith Richardson Fellow on the Peace Operations Team at the National Defense University's Institute for National Strategic Studies.

Danny M. Johnson is a Senior Management Analyst assigned to DCSOPS, 5th Signal Command, Mannheim, Germany. He is the author of the recently published work *Military Communications Supporting Peacekeeping Operations in the Balkans* and was a contributor to the recently published *Oxford Companion to Military History*.

Willard P. Meaker, U.S. Army retired, is a Telecommunications Specialist assigned to DCSOPS, 5th Signal Command, Mannheim, Germany. Mr. Meaker was the COR for the Bosnia Commercialization Program and is currently the Kosovo Commercialization Project Manager.

Paul Miller spent 25 years in the Royal Air Force as an Air Traffic Control Officer and subsequently in appointments at EUROCONTROL and, from 1993-2000, on the International Staff supporting the NATMC at HQ NATO in Brussels.

Joseph Nowick, Major USAR, 432nd Civil Affairs Battalion and OSCE Regional LNO, Task Force Falcon, 2A Rotation.

Steven M. Seybert, Major U.S. Army (Ret.), works for Coleman Research Corporation and has provided contract support to the U.S. Army Land Information Warfare Activity (LIWA) for 4 years of planning and conducting information operations with field support teams. He has planned and executed information operations with field support teams on more than 20 deployments to various levels of military command, including joint task force, army service component, numbered army, corps, and division. He performed as the Information Operations Targeting Officer while deployed with a LIWA FST to the Multinational Brigade—East in Kosovo during Operation Joint Guardian from March to August 2000. A graduate of the U.S. Military Academy at West Point and the Command and General Staff Course, he retired from the U.S. Army after serving as a military intelligence officer in a variety of command and staff positions at various levels, from a U.S. Army division to a U.S. national agency.

Jamie P. Shea is a senior official of the International Staff of NATO and Director of Information and Press. He was the public voice of NATO during the Kosovo conflict from March to June 1999 when he was Spokesman of NATO and Deputy Director of Information and Press.

Patrick J. Sheets, Colonel USAF, is a career Air Battle Manager with over 2,000 flying hours in both E-3 B/C, Airborne Warning and Control System (AWACS) and E-8C Joint Surveillance target Attack Radar System (JSTARS). He is currently the commander of the Nellis Combined Aerospace Operations Center (CAOC), the newest Air Force organization activated to provide continuous training and tactics

development for the operational level of warfare. He flew in NATO E-3As, U.S. E-3 B/Cs and U.S. E-8Cs during the Air War over Serbia and then was the Chief of Staff, United States Air Forces Europe Studies and Analysis (USAFE/SA), who were tasked by the Chief of Staff of the Air Force to write the after action report for the Air War over Serbia.

Pascale Combelles Siegel's research focuses on information operations (mainly public affairs, psychological operations, and military-media relations). She directed the NATO lessons learned examination of these issues for the first 16 months of operations in Bosnia-Herzegovina. She lectures at U.S. and European defense schools, and is an adjunct professor at the French Military Academy at St. Cyr. Ms. Combelles Siegel is extensively published on both sides of the Atlantic. Recent publications include two CCRP monographs: *Information Campaigns for Peace Operations* (co-author) and *Target Bosnia: Integrating Information Activities in Peace Operations: The NATO-led Operations in Bosnia-Herzegovina: December 1995-1997*. Ms. Combelles Siegel is an independent consultant based in McLean, VA.

ABOUT THE EDITOR

Larry K. Wentz is an independent consultant and director of the ASD(C3I) CCRP-sponsored lessons from Kosovo study. He held a similar CCRP position in 1996-1998 when he was on a special government assignment from the MITRE Corporation to the National Defense University and conducted the lessons from Bosnia study. Prior to the Kosovo assignment, he served a year and a half as Vice President of Advanced Communication Systems Services, Washington, and before that spent 30 years with the MITRE Corporation, a not-for-profit Federally Funded Research and Development Center. Mr. Wentz has an undergraduate degree in Electrical Engineering and a graduate degree in Systems Engineering and Operations Research. He has completed the Executive Management Program at the University of Pennsylvania's Wharton Business School and the Harvard John F. Kennedy School of Government Program for Senior Executives in National and International Security. He is a contributing author to the AFCEA International Press books, *The First Information War and CYBERWAR 2.0* and Canadian Peacekeeping Press books, *The Cornwallis Group Series*. The NDU/CCRP press published his book, *Lessons from Bosnia: The IFOR Experience*. Findings from Mr. Wentz's lessons from the Gulf War study were cited in Alvin and Heidi Toffler's book, *War and Anti-War*. He has lectured at the Canadian International Pearson Peacekeeping Training Centre, the NDU School of Information Warfare and Strategy, the George Mason University Program on Peacekeeping Policy, and the DIA Joint Military Intelligence Training Center. Mr. Wentz holds the position of Outside Director and Chairman of the Government Security Committee for the Board of Directors for Systematic Software Engineering, Inc. He is also a member of the American Institute for Aeronautics and Astronautics Information and C2 Systems Technical Committee.